

Technical Description And User Manual

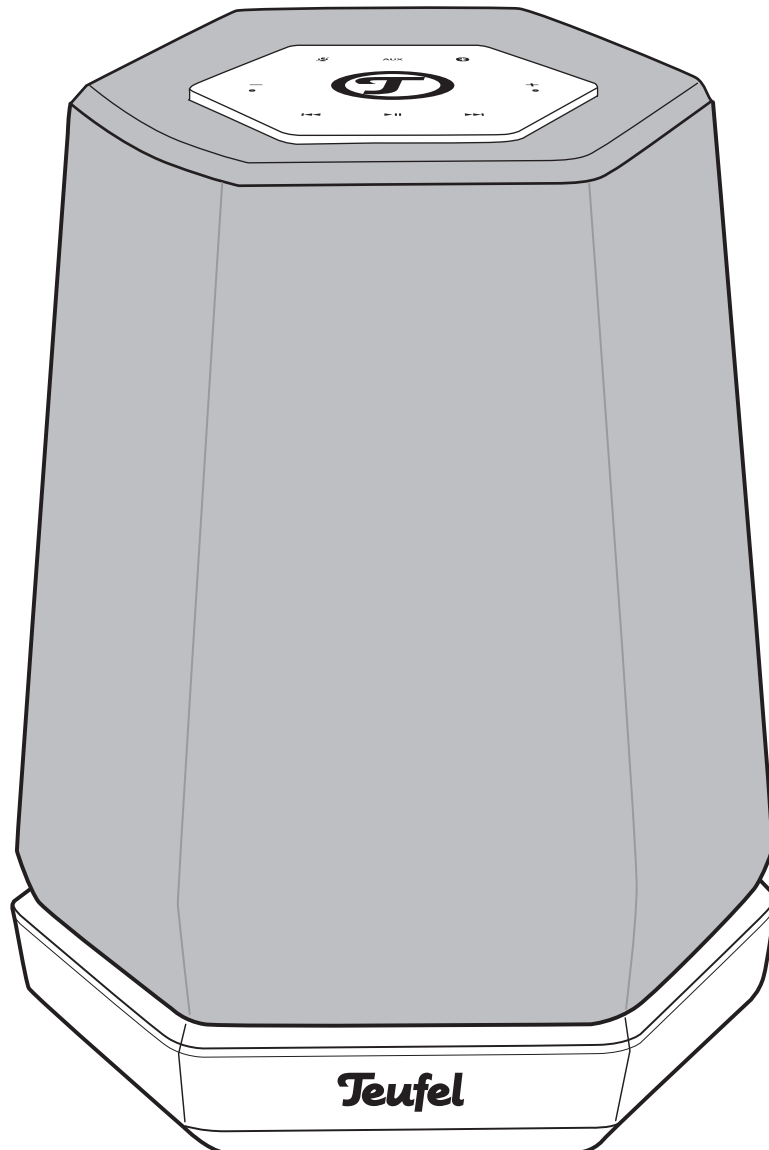

Holist M

360° Speaker with Alexa Voice Service

Teufel

Contents

General Notes And Information	3	Operation	16
Notice	3	Activating and deactivating	16
Trademarks	3	Selecting a source	16
Amazon Alexa privacy and advertising policy	3	Adjusting the volume	16
Original packaging	3	Adjusting the bass	17
Complaints	4	Sound Modes.....	17
Contact.....	4	Bluetooth® Mode.....	17
		Bluetooth® options	17
For Your Safety	5	Pairing and connecting.....	18
Proper use	5	Playback.....	18
Explanation of terms.....	5	Interruption of connection	19
Safety notes	6	Terminating the connection ...	19
Explanation of symbols	8	Spotify	19
		AUX playback.....	19
Overview	9	Care And Cleaning	20
Unpacking.....	9	Troubleshooting	21
Package contents	9	Technical Data	23
Optional items	9	Declaration Of Conformity	23
Checking the package contents	9		
Controls And Connections	10		
Location	12		
Location tips.....	12		
Optional base.....	12		
Connecting	13		
Analogue source	13		
Power supply	13		
Activating and deactivating.....	13		
Setup	14		
Teufel Holist app	14		
Amazon Alexa app.....	15		
Teufel Guide	15		

General Notes And Information

Notice

The information in this document may change without prior notice and in no way constitutes any liability on the part of Lautsprecher Teufel GmbH.

No part of this user manual may be reproduced in any form or be broadcasted in any way electronically, mechanically, by photocopy or recording without the written permission of Lautsprecher Teufel GmbH.



© Lautsprecher Teufel GmbH

Version 1, February 2020

Trademarks

® All trademarks are the property of their respective owners.

 **Bluetooth**® The Bluetooth® word mark and Bluetooth® symbol are registered trademarks of Bluetooth SIG, Inc. and any use by Lautsprecher Teufel is licensed.

 |  The Spotify Software is subject to third party licenses found here: <https://www.spotify.com/connect/third-party-licenses>



Alexa and all related logos and motion marks are trademarks of Amazon.com, Inc. or its affiliates.

Amazon Alexa privacy and advertising policy

Lautsprecher Teufel GmbH is no way affiliated with any of the services on the Amazon Alexa system. We do not record any personal information and do not promote any over air advertisements.

Original packaging

If you wish to exercise your eight-week right of return, we ask that you be absolutely sure to hold onto the packaging. We can only accept product returns with the ORIGINAL PACKAGING.

Empty boxes are not available!

Complaints

In case of a complaint we will need the following information to process your enquiry:

1. Invoice number

Can be found on the sales slip (enclosed with the product) or on the order confirmation received as a PDF document.

2. Serial number or batch number

Located on the bottom side of the device.

Thank you for your support!

Contact

Please contact our customer service department with any questions, suggestions, or complaints:

Lautsprecher Teufel GmbH
BIKINI Berlin
Budapester Str. 44
10787 Berlin (Germany)

Telephone:

00800 200 300 40 (toll-free)

Fax:

+49 (0)30 / 300 930 930

Online support:

www.teufelaudio.com/service

Contact form:

www.teufelaudio.com/contact



Before operating the product for the first time, please read the safety notes and user manual carefully. This is the only way to use all functions safely and reliably. Store the user manual in a safe place and also be sure to pass it on to any subsequent owner.

NOTICE

Check that all items have been delivered and that nothing is damaged. If you find any damage, do not operate the device; instead contact our customer service department.

For Your Safety

Proper use

The speaker is designed for the playback of music and speech from an external player or the internet.

Only use the speaker as described in this user manual. Any other use will be deemed as not in accordance with the instructions and may lead to damage to property or even persons.

The manufacturer accepts no liability for damage caused by improper use.

The speaker is intended for private use.

Explanation of terms

You can find the following signal terms in this user manual:

WARNING

This signal term indicates a moderate risk, which, if not avoided, may result in severe injury.

CAUTION

This signal term indicates a low risk, which, if not avoided, may result in minor or moderate injury.

NOTICE

This signal term warns you of potential damage.

Safety notes

This chapter contains general safety notes which you should always observe to protect yourself and third parties. Also observe the warning notes in each chapter of this user manual.

WARNING

Touching live parts can result in severe injury or death.

- Make sure that the correct voltage is present. You can find more information about this on the rating plate.
- Check the device regularly for damage. Immediately disconnect the mains plug and do not operate the device if its housing or mains cord is defective or exhibits other visible damages.
- This device is disconnected from the grid by pulling the mains plug. Thus, make sure that the mains plug is always easily accessible.
- If the device emits smoke, smells burnt or produces unusual sounds, immediately disconnect it from the mains and do not operate it further.
- Never open the device housing. Repairs may only be carried out by an authorised specialist workshop. Only parts that match the original specifications may be used.
- Only use the accessory products specified by the manufacturer.
- Only use the device indoors.

- Do not operate the device in wet rooms and protect it from dripping and splashing water. Make sure that no vases or other liquid-filled objects are located on or near the device in order to prevent liquid from penetrating the housing. If water or other debris ends up penetrating the housing, immediately pull the mains plug and, if applicable, take out any batteries. Then send the device to our service address.
- Never modify the device. Unauthorised modifications may affect the safety and functionality.
- Never touch the mains plug with wet hands.

WARNING

An unsuitable setup location may result in injury and damage.

- Never use the device unmounted in vehicles, in unstable locations, on wobbly tripods or furniture, on insufficiently dimensioned brackets etc. The speaker could tip or fall down and cause injury to persons or be damaged itself.
- Arrange the device so that it cannot be knocked over accidentally and make sure that the cables do not pose a tripping hazard.
- Do not place the device near heat sources (e. g. heaters, ovens, other heat generating equipment such as amplifiers etc.).

- Do not use the device in environments where there is a risk of explosion.
- Only use the wireless function (Bluetooth®, wireless subwoofer) in locations where wireless radio transmission is allowed.

WARNING

Children can become trapped in the plastic wrapping when playing and suffocate.

- Do not allow children to play with the device or the plastic wrapping. There is a danger of suffocation.
- Never allow children to operate electrical equipment unsupervised.

CAUTION

Extended listening at high volumes may lead to hearing loss.

- To avoid damage to health, avoid extended listening at high volumes.
- When the volume is set high, always keep a certain distance from the device and never place your ears directly on the speaker.
- If your amplifier is set to full volume, it may produce very high sound pressure. This may have psychological consequences and also cause physical injury. Children and pets are particularly at risk. Set your signal source device volume to a low setting before turning on the power.

CAUTION

This product contains magnetic material.

- If necessary, consult your physician and ask for effects on implants such as pacemakers or defibrillators.

CAUTION

Improper use may lead to damage or fire.



- Do not place open flames such as burning candles or similar on the device.
- Ensure sufficient ventilation.
- Do not place the device in direct sunlight.

NOTICE

The isolation pads can produce discolouration on sensitive surfaces.

- On parquet, varnished wood and similar surfaces, you should stick felt gliders to the rubber feet of the device or put a blanket under it. This will prevent discolouration of the floor over the long term.

Explanation of symbols

	Protection class II Dual insulation
	May only be used indoors
	Risk of electrical shock – do not open the housing. Disconnect the mains cord before changing a fuse.



Old devices must not be disposed of with household waste!

■ Electrical equipment contains harmful substances and valuable resources.

Every consumer is required by law to bring all old electrical devices to an authorised collection or return point so that they can be disposed of in a manner that is environmentally friendly and which preserves resources.

You can hand old electrical devices over to the local reusable materials/recycling centre.

Please contact your vendor directly for more information about this topic.

Overview

Unpacking

- Carefully open the box and carefully lift the device out of the box.

Package contents

- (1) 1× Holist M
- (2) 1× mains cord

Optional items

- (3) Tripod stand

Checking the package contents

- Check that all items have been delivered and that nothing is damaged.
- If the delivery is incomplete or exhibits damage from transport, please contact our service department (see Page 4).
- Do not in any case operate the device if it is damaged.

(1)

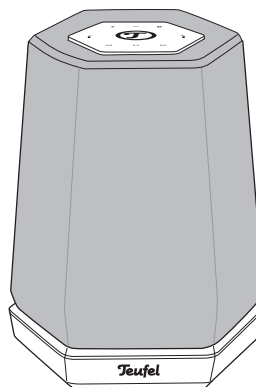

(2)

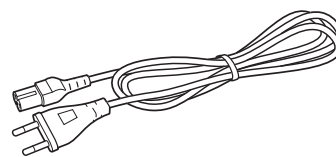

(3)

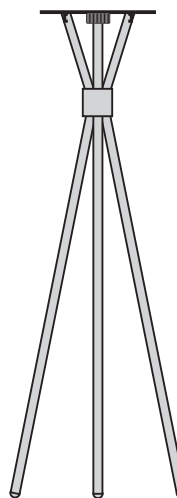

Controls And Connections

Top panel

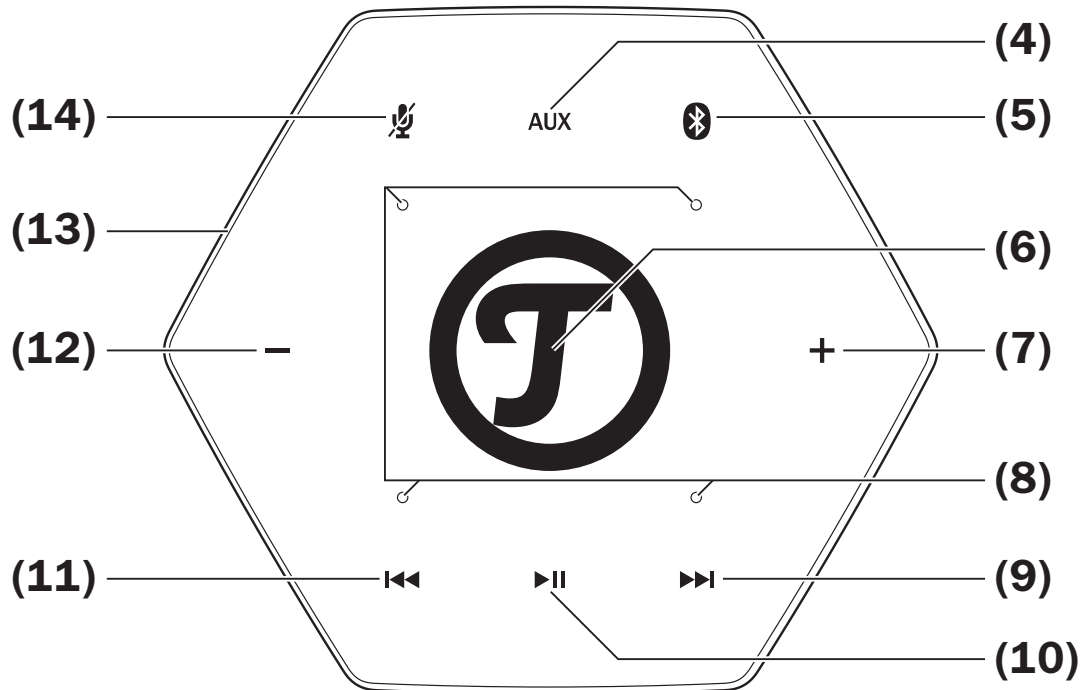

(4) **AUX** – select the AUX source

(5) **Bluetooth** – short press: select the Bluetooth source and initiate auto reconnect;
long press: activate pairing

(6) **Action Button** – short press: activate Alexa functionality (e.g. ends Timer, Ends Call, ...);
long press: opening wireless network for configuration

(7) **+** – increase the volume

(8) Four built-in microphones

(9) **▶▶** – skip forward

(10) **▶||** – start/pause playback

(11) **◀◀** – skip back

(12) **-** – decrease the volume

(13) Indication LED ring

(14) **Microphone icon** – enable/disable microphone for Alexa commands

Bottom view

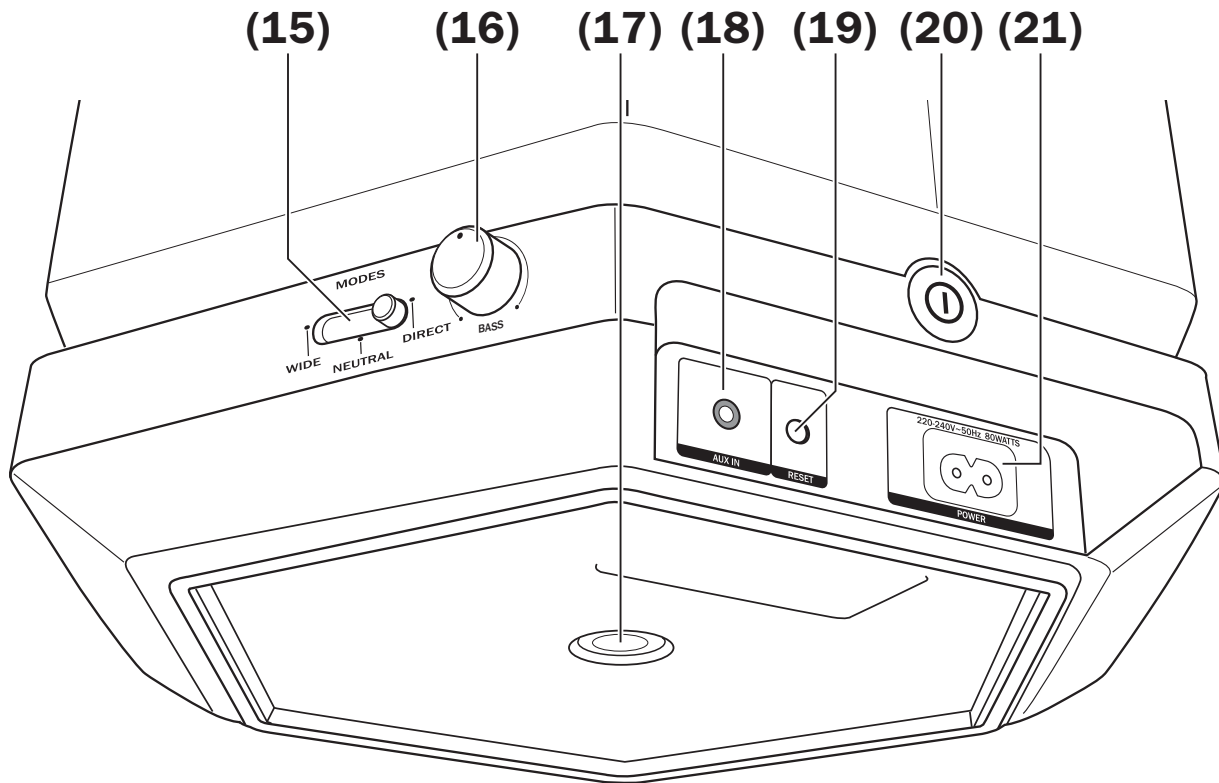

- (15) MODE** – select sound mode (see page 17)
- (16) BASS** – set bass volume
- (17)** Threaded hole (M6) for mounting the device on the optional tripod
- (18) AUX IN** – input jack for analogue audio source device

- (19) RESET** – reset the device
- (20) ⓐ** – switch the device on or off
- (21) POWER** – connector jack for the mains cord **(2)**

Location

NOTICE

If the device is subjected to warm temperatures after being cold (e. g. after transport), condensation may occur inside of it.

– *In this case, wait approx. 2 hours before you connect and activate it.*

The isolation pads can produce discolouration on sensitive surfaces.

– *On parquet, varnished wood and similar surfaces, you should stick felt gliders to the rubber feet of the device or put a blanket under it. This will prevent discolouration of the floor over the long term.*

Location tips

- Select a stable, level base.
- Make sure that the environment is clean and free from dust.
- Select a location away from heat sources and direct sunlight.
- Do not place any objects on the cables or the device.

Optional base

In our web shop you can purchase a stable base for the Holist M with a mounting height of 73 cm (2 ft 4).

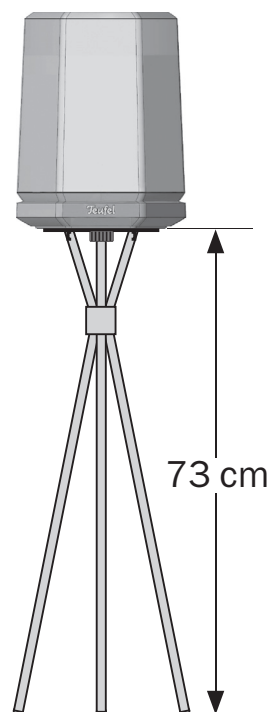

Connecting

CAUTION

Risk of injury/damage!

- Lay the cables so that they do not pose a tripping hazard.



Analogue source

You can connect a source device with analogue sound (e. g. a CD player or TV set) to the AUX jack **(18)**. You will need a stereo cable with a 3.5-mm jack plug to do so.

Power supply

1. Insert the small plug of the enclosed mains cord **(2)** into the POWER jack **(21)**.
2. Connect the mains cord with a mains socket.

Activating and deactivating

- Turn the Holist M on or off with the  button **(20)**.
The Indication LED ring **(13)** starts to rotate in red and the  button **(20)** lights in white.

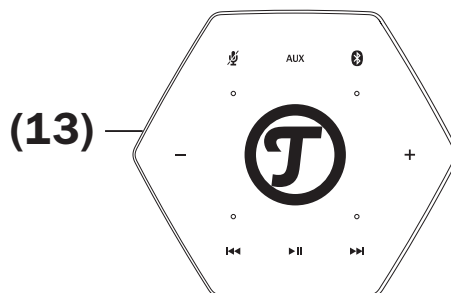
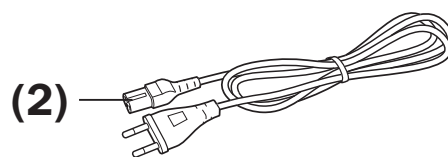
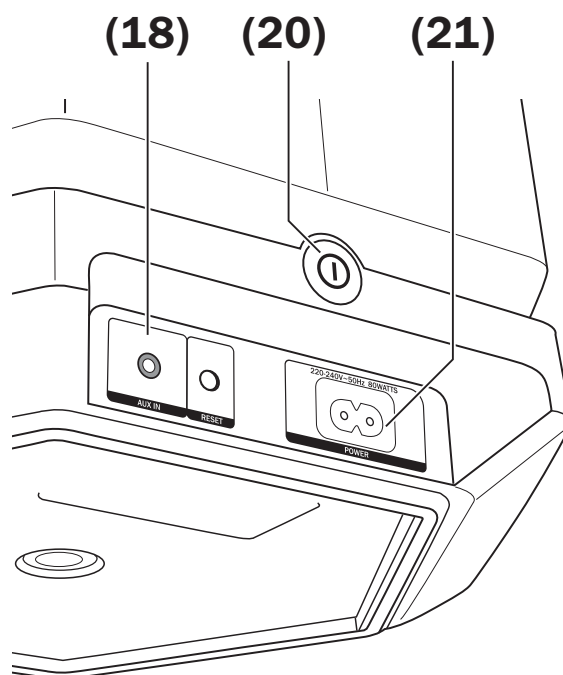

Setup

The setup is done in five major steps:

1. Connect and power up the Holist M.
2. Download the Teufel Holist app to your smartphone or tablet.
3. Connect the Holist M via the Teufel Holist app to your home Wi-Fi.
4. Log In via the Teufel Holist app to your Amazon Account to enable Alexa for the Holist M.
5. Download the Amazon Alexa app for more features.

Teufel Holist app

The Teufel Holist app is used for the setup and configuration of the Holist M. After the setup, you can control a lot of functions of the Holist M from the app.

When you start the Teufel Holist app, it searches for new software for your Teufel devices. If so, you can install the update with only one touch.

- Load the Teufel Holist app from the Play Store/App Store.
- Make sure that your smartphone or tablet is registered in the same Wi-Fi you want your Holist M to be in.
- Have the Wi-Fi password for your router ready.
- Once you have started the app, the setup wizard will guide you through the setup process.

After connecting to your Wi-Fi network, you can setup your Amazon account to use the features of Amazon Alexa.

- Have the username and password for your Amazon account ready.
- In the menu of the Teufel Holist M app choose “AMAZON ALEXA”.
- Follow the instructions on the screen of your smartphone or tablet.



Amazon Alexa app

You can use the Amazon Alexa app for several smart features of the Holist M and you can change your device's name, device location, time zone and other settings.

Open the Amazon Alexa app and sign in to your existing Amazon account, or create a new account.

If you have setup your Amazon account in the Teufel Holist app, your Holist M will be listed in the device list.

 Many of Alexa's services are location based. Therefore you should set the correct location of your Holist M in the Alexa app (see the help menu in the Alexa app).

Teufel Guide

You will find more information and help on our web guide:

<https://www.teufelaudio.com/holist>



Operation

Activating and deactivating

The Holist M is designed to be always on – so you are able to use Alexa Voice commands whenever you want.

- Turn the Holist M on or off with the **⓪** button **(20)**.
- To deactivate the microphone press the **🚫** button **(14)**. The LED ring **(13)** will light up in red, indicating the microphones to be turned off.

Selecting a source

- Use the **📶** button **(5)** to select the digital Bluetooth® source directly.
- Use the **AUX** button **(4)** to select the analogue source AUX directly.
- All other sources (e. g. streaming services, internet radio etc.) you can select in the Teufel Holist app, the Alexa app or by the Axela Voice Service.

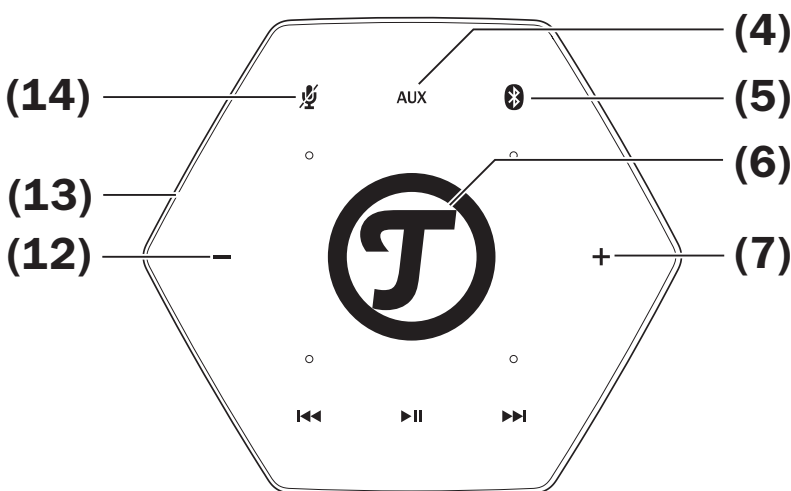

Adjusting the volume

i The volume setting of an external player often affects the volume of the Holist M.

- Push the **–** button **(12)** to decrease and the **+** button **(7)** to increase the volume. The LED ring **(13)** shows the current value while making the setting.
- You can control the volume even with both, the Teufel Holist app and the Alexa app.

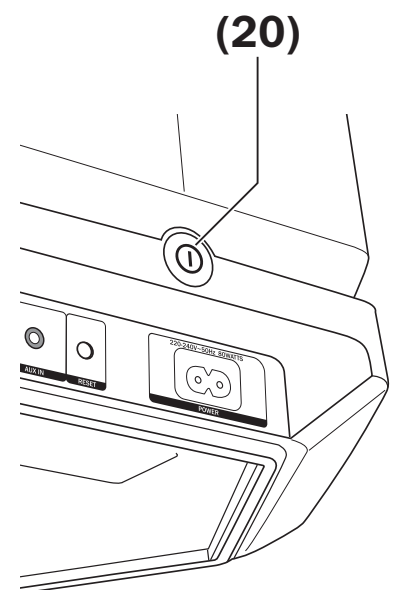

Adjusting the bass

Use the BASS control **(16)** to set the level of the internal subwoofer:

- Turn the control to the right to increase and to the left to decrease the bass.

Sound Modes

You can select three sound modes with the MODES switch **(15)**:

- WIDE: This creates a more spaciousness sound.
- NEUTRAL: Balanced spatial 360° sound.
- DIRECT: A clear sound for messages and magazines

The sound modes WIDE and DIRECT are effective when you are listening in front of the Holist M.

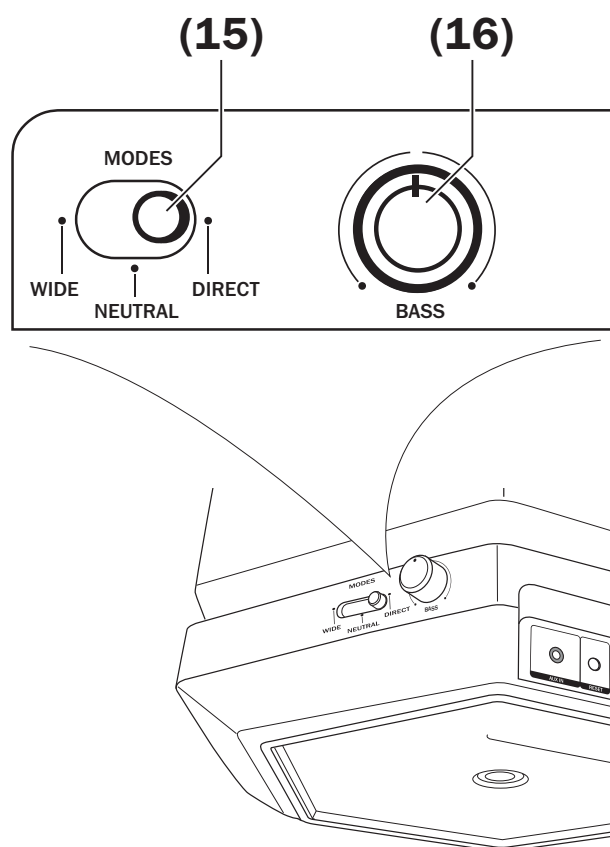

Bluetooth® Mode

Via Bluetooth®, you can establish a wireless connection between a compatible external player and the Holist M. The audio output of your external player is then emitted by the Holist M.

The Bluetooth® wireless transmission system has a range of approximately 10 metres that is limited by walls and furnishings. If the connection is cut off, the Holist M will attempt to re-establish a connection until you select another source.

NOTICE



- *Only use the Bluetooth® function in locations where wireless radio transmission is allowed.*
- *Please keep in mind that the Bluetooth® behaviour may differ depending on the external player's operating system and settings (e. g. equalizers or effect apps).*

Bluetooth® options

Depending on the device type, your external player/smartphone may also have a menu for Bluetooth® options such as media playback. Here you can activate and deactivate the desired options. You can find more information about the Bluetooth® options in the user manual for your external player/smartphone.

Pairing and connecting

To play the audio of your external player on your Holist M via Bluetooth®, connect the devices with each other. This is called “Pairing”.

1. Turn on the Bluetooth® function on your external player (e. g. smartphone).
2. Push the button  (5) to select the “Bluetooth” input on the Holist M.
3. Push the button  (5) again and hold it down for approx. 3 seconds to start the pairing process. The LED ring (13) shows three blue corners.
4. Let your external player/smartphone scan for Bluetooth® devices. You will find more information about this in the user manual of your external player. After the search run, the “Teufel Holist” should also be present in the list of detected devices.
5. Select “Teufel Holist” from the list of detected devices.
6. If your external player asks for a code, enter “0000” (four zeros).



Pairing is now complete. You hear a beep tone and the LED (13) ring will illuminate full white for 1 sec. Your Holist M will now act as a Bluetooth® playback device and will play back all sounds that would otherwise be played by your external player/smartphone.

Playback

 The volume setting of the external player affects the volume of the Holist M.

1. Push the  button (5) to select Bluetooth® as the source.
2. Turn on the Bluetooth® function on your source device.
3. Start playback on your source device.

You can control playback on your source device. You can also control some functions with the Holist M:

- Pause playback:
Push the  button (10).
- Continue playback:
Push the  button (10) again.
- Play next track:
Tap the  button (9).

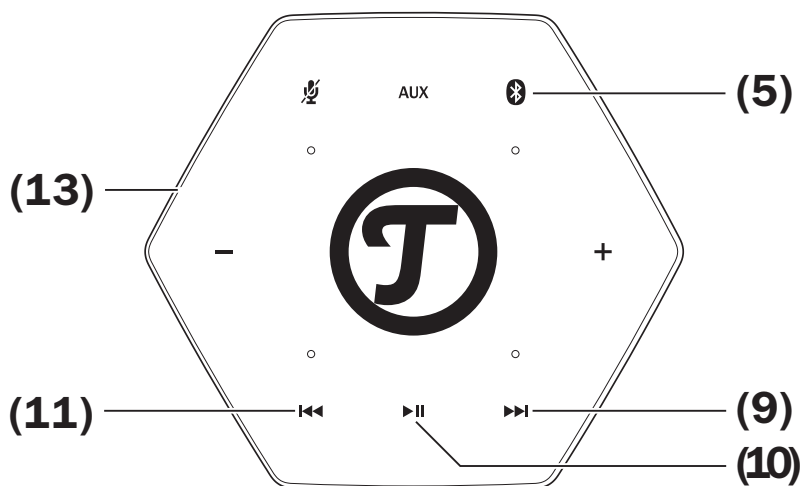

- Restart the current track:
Tap the **I◀◀** button **(11)**.
- Play previous track: Tap the **I◀◀** button **(11)** twice.
- If your source device is a smart-phone, the Bluetooth® connection will be interrupted in the event of an incoming call and you can make phone calls as usual. After finishing your phone call, the sounds will once again be diverted and played back by your Holist M.

Interruption of connection

If your external player moves out of the range of your Holist M, the Bluetooth® connection will be interrupted. If you are back within range within 120 seconds, the connection will be re-established automatically.

Terminating the connection

To terminate the Bluetooth® connection, deactivate the Bluetooth® function on your external player/ smartphone or press the **📶** button **(5)** shortly again.

Spotify

Use your phone, tablet or computer as a remote control for Spotify.

Go to spotify.com/connect to learn how.

AUX playback

The AUX IN jack **(18)** serves to connect an external player using a stereo cable with a 3.5 mm jack plug. You can connect any external players with a line-out jack or headphone jack.

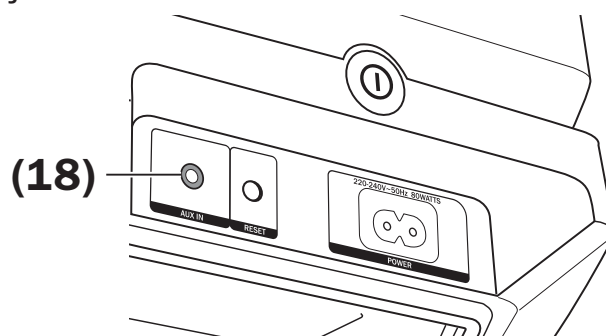

1. Push the AUX button **(4)** to select AUX IN as the source.

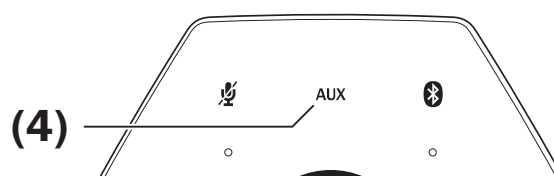

i The volume setting of the external player affects the volume of the Holist M.

2. Start playback on your external AUX player.
3. Control all playback functions via the external player.

Care And Cleaning

NOTICE

External influences may damage or destroy the device.

- *If the device is to be left unattended for a prolonged period of time (e. g. during a vacation) or if a thunderstorm is forecast, pull the mains plug out of the socket. Otherwise, sudden overvoltage could cause the device to become defective.*
 - *If possible, only use plain water without any additives. In case of stubborn marks, a mild soap solution may be used.*
 - *Do not use caustic cleaning products, white spirit, thinners, petrol or similar under any circumstances. Such cleaning agents may damage the delicate surface of the housing.*
- Ideally, you should remove dust or small amounts of dirt with a dry, smooth leather cloth.
 - Use a damp cloth to rub off stubborn dirt. Make sure that no liquid penetrates the housing.
 - Then immediately wipe the damp surfaces off with a soft cloth without applying pressure.

Troubleshooting

The following advice should help you to solve problems. If this does not help, you will find useful information in the detailed FAQs on our website. Otherwise, please contact our hotline (see page 4). Take note of the warranty instructions.

Problem	Possible cause	Solution
No function.	No power supply.	Check the function of the socket with another device.
The device doesn't emit any sound.	The wrong source has been selected.	Select the right source (page 16).
	The volume is set to "0".	Increase the volume.
	The volume of the external player has been set too low.	Carefully increase the volume of the external player.
No sound with Bluetooth®.	No Bluetooth® connection.	Establish a connection (see page 18).
	Holist M has not been selected as the output device.	On the external player, select "Teufel Holist" as the Bluetooth® output device.
	Bluetooth® connection impaired by another radio system (e. g. cordless telephone, Wi-Fi).	Set up the Holist M and/or external player in another location. Move to another room to test.
Music playback skips or is interrupted.	<p>It is possible that Holist M does not have a Wi-Fi signal or it is too weak.</p> <p>Place the Holist M closer to the router, try alternative setup locations.</p> <p>As a test, refrain from using repeaters. If applicable, use an audio stream with low resolution.</p> <p>Also visit the website of the router manufacturer for tips on how to improve your Wi-Fi.</p>	

<p>The setup via app fails.</p>	<p>Restart your router and your smartphone or tablet.</p> <p>Set up the Holist M near your router and switch any repeaters off for the duration of the setup process. If your router provides guest access, do not use it to connect your Holist M.</p> <p>Read the notes in our online documentation at: https://www.teufelaudio.com/holist.</p>
<p>The Teufel Holist app is not connected or fails to locate the configured device.</p>	<p>Make sure that the Holist M is operated with the Teufel Holist App on the same Wi-Fi. Restart your router. Briefly disconnect your Holist M from the power supply and then start them again.</p> <p>You can find more information in our online documentation: https://www.teufelaudio.com/holist.</p>
<p>I would like to reset the device.</p>	<p>Notice: By resetting the device, all system configuration settings will also be reset.</p> <p>Resetting the device: When the device is switched on, use a paper clip that has been bent straight to push the RESET button (19) and hold it down until the device restarts (for at least 8 seconds).</p>

Technical Data

Dimensions (W × H × D)	270 × 400 × 240 mm
Weight	6.51 kg
Operating voltage	220–240 V~, 50 Hz, 120 W max.

You can find further technical data on our website. Technical changes reserved!

Declaration Of Conformity

 Lautsprecher Teufel GmbH hereby declares that this product complies with the requirements of the directives 2014/30/EU, 2014/35/EU and 2014/53/EU to the extent they are installed and used in accordance with the instructions of the manufacturer. The full text of the EU declaration of conformity is available at the following Internet address:

www.teufelaudio.com/konformitaetserklaerungen.html

The following radio frequency bands and radio transmitting powers are used in this product:

Radio network	Frequency bands in MHz	Transmission power in mW/dBm
Bluetooth®	2,402–2,480	2.5/4
WiFi/WLAN	2,400–2,483	40/16
	5,150–5,250	25/14
	5,250–5,350	25/14
	5,500–5,700	25/14
	5,725–5,845	25/14

Teufel

Please contact our customer service department with any questions, suggestions, or complaints:

Lautsprecher Teufel GmbH

BIKINI Berlin

Budapester Str. 44

10787 Berlin (Germany)

Telephone: 00800 200 300 40 (toll-free)

Fax: +49 (0)30 / 300 930 930

Online support: www.teufelaudio.com/service

Contact form: www.teufelaudio.com/contact

No responsibility is assumed for the correctness of this information.
Technical changes, typographical errors and other errors reserved.