

Technical Description And User Manual

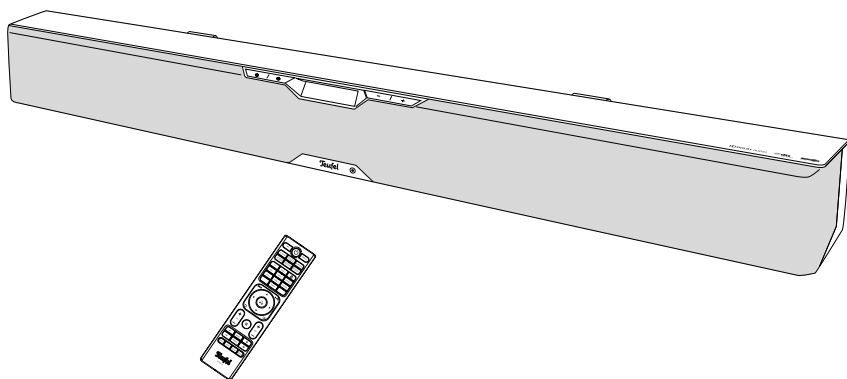

Cinebar Pro

2.1 Soundbar with wireless technology

Teufel

Contents

General Notes And Information	3	Operation	19
Notice	3	Activating and deactivating.....	19
Trademarks	3	Selecting a source	19
Original packaging	3	Adjusting the volume	20
Complaints	4	Mute	20
Contact.....	4	Adjusting the volume of the	
For Your Safety	5	subwoofer.....	20
Proper use	5	Adjusting the sound	20
Explanation of terms.....	5	Equalizer.....	20
Safety notes	5	Stereo widening	21
Explanation of symbols	7	Dolby Audio and Dolby mode.....	21
Overview	8	Menu.....	22
Unpacking.....	8	Other settings	26
Package contents	8	Google Chromecast	27
Checking the product contents....	8	Spotify CONNECT	27
Controls And Connections	9	Bluetooth® Mode.....	28
Remote Control	11	Software Update	30
Inserting/changing the		Installing new software.....	30
batteries	12	Care And Cleaning	31
Setup/Wall Mounting	13	Troubleshooting	32
Setup location	13	Technical Data	34
Location tips.....	13	Declaration Of Conformity	34
Mounting the speaker stand	13	Disposal	35
Wall mounting	14	Important information in	
Connecting	15	accordance with the Electrical	
TV set.....	16	and Electronic Equipment Act	
HDMI source	16	(Germany: ElektroG).....	35
Analogue source	17	Important information about	
Optical-digital source.....	17	the Batteries Act	
Coaxial digital source	17	(Germany: BattG)	36
Rear speakers.....	17		
Subwoofer	17		
Headphones.....	18		
Power supply	18		

General Notes And Information

Notice

The information in this document may change without prior notice and in no way constitutes any liability on the part of Lautsprecher Teufel GmbH.

No part of this user manual may be reproduced in any form or be broadcasted in any way electronically, mechanically, by photocopy or recording without the written permission of Lautsprecher Teufel GmbH.

© Lautsprecher Teufel GmbH
Version 2.0, February 2022

Trademarks

® All trademarks are the property of their respective owners.

 Manufactured under licence from Dolby Laboratories. **DOLBY** Dolby, Dolby Audio, Pro Logic AUDIO and the double D symbol are trademarks of Dolby Laboratories.

 You can view the DTS patents at <http://patents.dts.com>.
Manufactured under license from DTS Licensing Limited. DTS, the symbol as well as DTS and the symbol collectively are registered trademarks. DTS Digital Surround is a trademark of DTS, Inc. © DTS, Inc. All rights reserved.

 **Bluetooth**® The Bluetooth® word mark and Bluetooth® symbol are registered trademarks of Bluetooth SIG, Inc. and any use by Lautsprecher Teufel is licensed.

 **HDMI**™ The HDMI and High-Definition Multimedia Interface terms as well as the HDMI logo are trademarks or registered trademarks of HDMI Licensing Administrator Inc. in the USA and other countries.

 Chromecast built-in
Chromecast is a trademark of Google Inc.

 The Spotify software is subject to third-party licences found here:
<https://www.spotify.com/connect/third-party-licenses>

Original packaging

If you wish to exercise your right of return, we ask that you be absolutely sure to hold onto the packaging. We can only accept product returns with the ORIGINAL PACKAGING.

Empty boxes are not available!

Complaints

In case of a complaint we will need the following information to process your enquiry:

1. Invoice number

Can be found on the sales slip (enclosed with the product) or on the order confirmation received as a PDF document, e.g. 4322543

2. Serial number or batch number

Located on the back side of the device, e.g. serial no.: KB20240129A-123.

Thank you for your support!

Contact

Please contact our customer service department with any questions, suggestions, or complaints:

Lautsprecher Teufel GmbH

BIKINI Berlin

Budapester Str. 44

10787 Berlin (Germany)

Telephone:

Germany: +49 (0)30 217 84 217

Austria: +43 12 05 22 3

Switzerland: +41 43 50 84 08 3

Fax: +49 (0)30 / 300 930 930

Online support:

www.teufelaudio.com/service

Contact form:

www.teufelaudio.com/contact



Before operating the product for the first time, please read the safety notes and user manual carefully. Only in this way, can you ensure that all functions are used in a safe and reliable manner. Store the user manual in a safe place and also be sure to pass it on to any subsequent owner.

NOTICE

Check that all items have been delivered and that nothing is damaged. If you find any damage, do not operate the device; instead contact our customer service department.

For Your Safety

Proper use

The speaker is designed for the playback of music and speech from an external player.

Only use the speaker as described in this user manual. Any other use will be deemed as not in accordance with the instructions and may lead to damage of property or even persons.

The manufacturer accepts no liability for damage caused by improper use.

The speaker is intended for private use.

Explanation of terms

You can find the following signal terms in this user manual:



This signal term indicates a low risk, which, if not avoided, may result in minor or moderate injury.

NOTICE

This signal term warns you of potential damage.

Safety notes

This chapter contains general safety notes which you should always observe to protect yourself and third parties. Also observe the warning notes in each chapter of this user manual.

Touching live parts can result in severe injury or death.

- Make sure that the correct voltage is present. You can find more information about this on the rating plate.
- Check the device regularly for damage. Immediately disconnect the mains plug and do not operate the device if its housing, mains adapter or mains cord is defective or exhibits other visible damages.
- This device is disconnected from the grid by pulling the mains plug. Thus, make sure that the mains plug is always easily accessible.
- If the device emits smoke, smells burnt or produces unusual sounds, immediately disconnect it from the mains and do not operate it further.
- Never open the device housing. Repairs may only be carried out by an authorised specialist workshop. Only parts that match the original specifications may be used.

- Only use the accessory products specified by the manufacturer.
- Only use the device indoors.
- Do not operate the device in wet rooms and protect it from dripping and splashing water.
Make sure that no vases or other liquid-filled objects are located on or near the device in order to prevent liquid from penetrating the housing. If water or other debris ends up penetrating the housing, immediately pull the mains plug and, if applicable, take out any batteries. Then send the device to our service address .
- Never modify the device. Unauthorised modifications may affect the safety and functionality.
- Never touch the mains plug with wet hands.

An unsuitable setup location may result in injury and damage.

- Never use the device unmounted in vehicles, in unstable locations, on wobbly tripods or furniture, on insufficiently dimensioned brackets etc. The speaker could tip or fall down and cause injury to persons or be damaged itself.
- Arrange the device so that it cannot be knocked over accidentally and make sure that the cables do not pose a tripping hazard.
- Do not place the device and the mains adapter near heat sources (e.g. heaters, ovens, other heat generating equipment such as amplifiers etc.).

- Do not use the device in environments where there is a risk of explosion.
- Only use the wireless function (Bluetooth®, wireless subwoofer) in locations where wireless radio transmission is allowed.

Children can become trapped in the plastic wrapping when playing and suffocate.

- Do not allow children to play with the device or the plastic wrapping. There is a danger of suffocation.
- Never allow children to operate electrical equipment unsupervised.

Swallowing a product battery may result in severe internal injury or even death.

- Store both new and used batteries so that they are not accessible to children.
- If it is no longer possible to safely close the battery compartment, stop using the remote control and store it so that it is not accessible for children.
- If you suspect that a battery has been swallowed or otherwise incorporated, promptly consult a physician.

Leaking battery acid may lead to chemical burns.

- Do not allow battery acid to come into contact with skin, eyes or mucous membranes. In the event of contact with acid, immediately flush the applicable areas with plenty of clean water and consult a physician if necessary.

Batteries (particularly lithium batteries) can explode if used improperly.

- Never attempt to recharge batteries.
- Only use batteries of the same or equivalent type.
- You must not heat or short circuit batteries and rechargeable batteries or dispose of them in fire.
- Do not expose batteries and rechargeable batteries to direct sunlight.

Extended listening at high volumes may lead to hearing loss.

To avoid damage to health, avoid extended listening at high volumes.

- When the volume is set high, always keep a certain distance from the device and never place your ear directly on the speaker.
- If your amplifier is set to full volume, it may produce very high sound pressure. This may have psychological consequences and also cause physical injury. Children and pets are particularly at risk. Set your signal source device volume to a low setting before turning on the power.

This product contains magnetic material.

- If necessary, consult your physician and ask for effects on implants such as pacemakers or defibrillators.



Improper use may lead to damage or fire.

- Do not place open flames such as burning candles or similar on the device.
- Ensure sufficient ventilation.
- Do not place the device in direct sunlight.
- Only use the device indoors.
- Do not operate the device in wet rooms and protect it from dripping and splashing water. Make sure that no vases or other liquid-filled objects are located on or near the device in order to prevent liquid from penetrating the housing.

The isolation pads can produce discolouration on sensitive surfaces.

- On parquet, varnished wood and similar surfaces, you should stick felt gliders to the rubber feet of the device or put a blanket under it. This will prevent discolouration of the floor over the long term.

Explanation of symbols

	Protection class II Dual insulation
	May only be used indoors
	Risk of electrical shock – do not open the housing. Disconnect the mains cord before changing a fuse.

Overview

Unpacking

- Carefully open the box and carefully lift the device out of the box.

CAUTION

Risk of injury/damage!

The red rubber loops on the back of the Cinebar Pro are just cord holders.

- Do not use the loops to carry the device!

Package contents

- (1) 1× Cinebar Pro
- (2) 1× power cord
- (3) 1× speaker stand
- (4) 2× M4 x 10 mm screw for the speaker stand
- (5) 1× remote control CB PRO RC
- (6) 2× AAA battery for the remote control

Checking the product contents

- Check that all items have been delivered and that nothing is damaged.
- If the delivery is incomplete or exhibits damage from transport, please contact our service department (see page 4).
- Do not in any case operate the device if it is damaged.

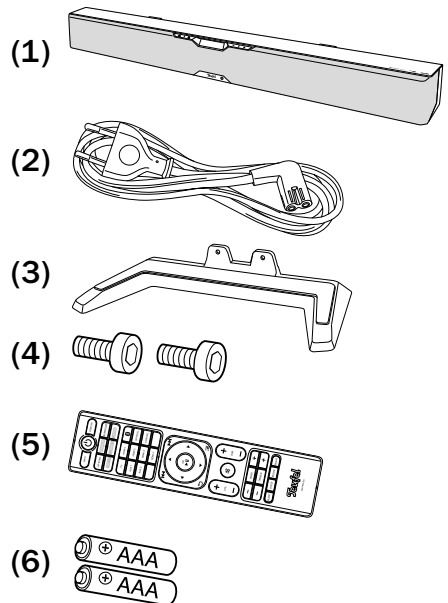

Controls And Connections

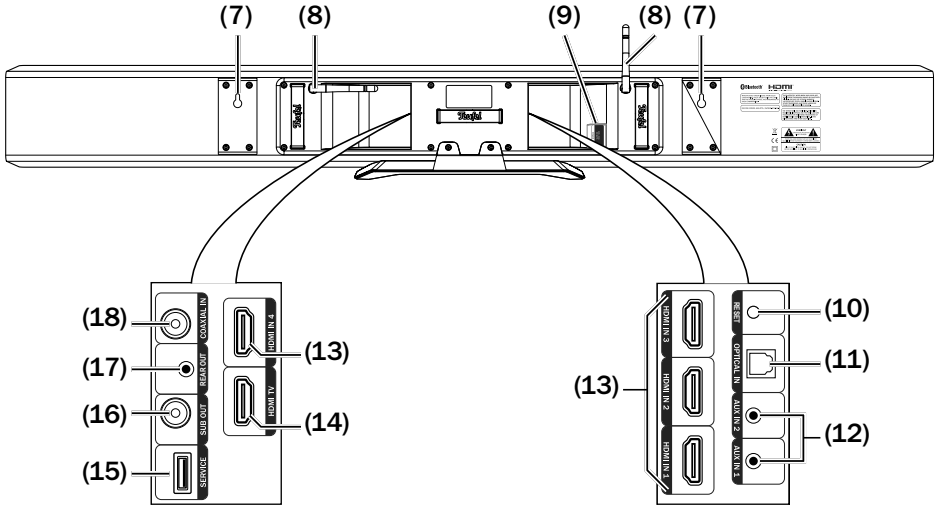

Back side

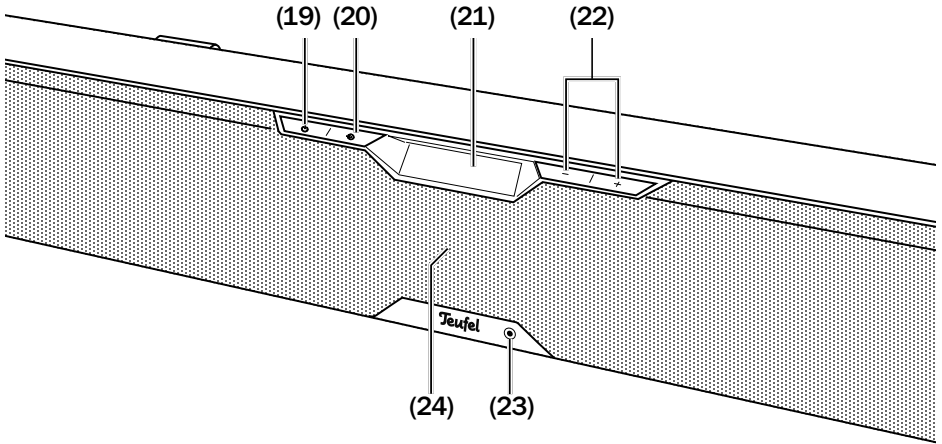

- (7) Keyhole openings for wall mounting
- (8) Wi-Fi antennas
- (9) POWER – connector jack for the mains cord (2)
- (10) RESET – push button to reset the device to the factory default settings
- (11) OPTICAL IN – input jack for digital audio source device
- (12) AUX IN 1/2 – input jack for analogue audio source device
- (13) HDMI IN 1-4 – connections for external HDMI devices
- (14) HDMI-TV – HDMI connection for the TV set
- (15) SERVICE – USB port for software updates
- (16) SUB OUT – output for the subwoofer
- (17) REAR OUT – output for rear speakers
- (18) COAXIAL IN – input jack for digital audio source device

Front side



- (19)  – switch the device on and to standby mode
- (20)  – select a source
- (21) Text field for the menu and information
- (22)  – increase/decrease the volume
- (23) Headphone jack
- (24) Stand-by display

Remote Control

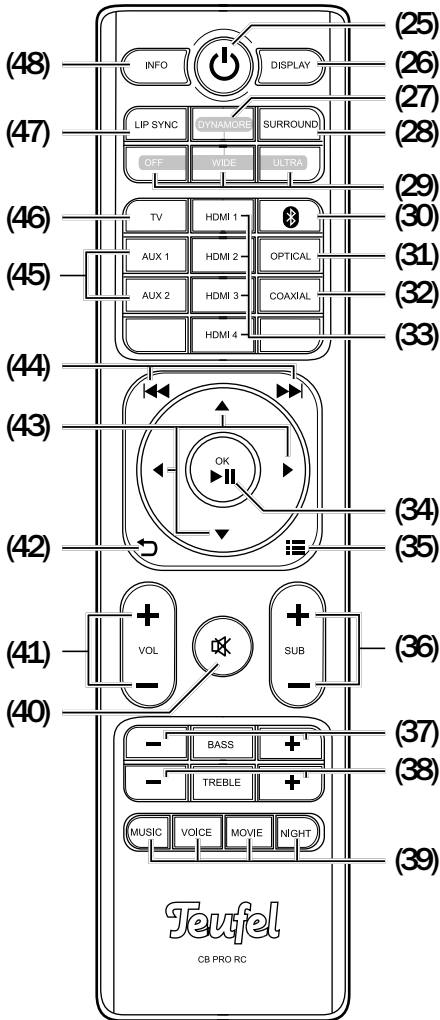

- (25) Switch the device on or to standby
- (26) Set the brightness of the text field (21)

- (27) Display current DYNAMORE setting
- (28) Set the surround sound
- (29) Set DYNAMORE stereo widening
- (30) Select the Bluetooth® source, start pairing
- (31) Select digital source OPTICAL
- (32) Select digital source COAXIAL
- (33) Select HDMI IN 1-4 as source
- (34) Confirm menu / control Bluetooth® device, Spotify and Chromecast: Start/pause playback
- (35) Access the menu
- (36) Adjust the subwoofer volume
- (37) Adjust the tone (bass)
- (38) Adjust the tone (treble)
- (39) Adjust the sound pattern: MUSIC, VOICE MOVIE, NIGHT
Double click = FLAT Equalizer
- (40) Mute the speaker
- (41) Increase/decrease the volume
- (42) Back button
- (43) Navigation buttons
- (44) Control Bluetooth® device, Chromecast and Spotify: Skip forward/back
- (45) Select analogue source AUX 1/2
- (46) Select TV as source via HDMI ARC
- (47) Set the audio delay
- (48) Display information about surround sound and the sound pattern

⚠ CAUTION

Leaking battery acid may lead to chemical burns.

- *Do not allow battery acid to come into contact with skin, eyes or mucous membranes. In the event of contact with acid, immediately flush the applicable areas with plenty of clean water and consult a physician if necessary.*

Batteries (particularly lithium batteries) can explode if used improperly.

- *Never attempt to recharge batteries.*
- *Only use batteries of the same or equivalent type.*
- *You must not heat or short circuit batteries and rechargeable batteries or dispose of them in fire.*
- *Do not expose batteries and rechargeable batteries to direct sunlight.*

Inserting/changing the batteries

In order to operate the remote control, you will need two type LR03 batteries (AAA – included in the package contents).

You should change the batteries if the remote control stops working properly or after 2 years at the latest:

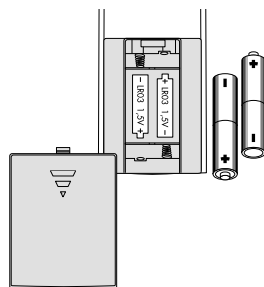

1. Gently depress the arrow on the battery compartment cover on the back side of the remote control. Push the cover down. Remove the cover.
2. If applicable, remove the old batteries and dispose of them.
3. Insert the new batteries according to the image in the battery compartment; make sure the polarity is correct.
4. Place the cover back on the compartment and push it closed.

Setup/Wall Mounting

NOTICE

If the device is subjected to warm temperatures after being cold (e.g. after transport), condensation may occur inside of it.

– *In this case, wait approx. 2 hours before you connect and activate it.*

Setup location

The space in front of or under the TV set is an ideal location.

Location tips

- Select a stable, level base. In case of wall mounting, follow the instructions in the next chapter.
- Make sure that the environment is clean and free from dust.
- Select a location away from heat sources and direct sunlight.
- Do not place any heavy objects on the cables or the device.

Mounting the speaker stand

To set up the Cinebar Pro on a table etc., please mount the speaker stand. For this, you will need a 3 mm hex key.

1. Place the Cinebar Pro on a soft base with the speaker cover grille down.
2. Place the speaker stand (3) on the corresponding recesses on the back of the Cinebar Pro.

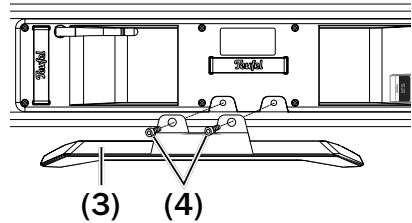

3. Use two screws (4) to screw the speaker stand tight.

NOTICE

The isolation pads can produce discolouration on sensitive surfaces.

– *On parquet, varnished wood and similar surfaces, you should stick felt gliders to the rubber feet of the device or put a blanket under it. This will prevent discolouration of the floor over the long term.*

Wall mounting

Proceed with care when mounting the Cinebar Pro on the wall and follow the instructions below.

You will need the following material to mount the product on a solid stone wall (not included in the package contents):

- 2 dowels (\varnothing 8 mm)
- 2 screws, 5 x 45 mm, screw head = \varnothing approx. \varnothing 8–10 mm

CAUTION

Risk of injury/damage!

- Only qualified persons may mount the Cinebar Pro on the wall.
- The device may only be mounted on a suitable, solid wall. Special dowels or anchors may be necessary when mounting the product on lightweight walls. Consult a qualified professional in this case.
- Make sure that there are no cables or pipes in the drilling areas. Before you drill, use a metal detector to check the applicable areas. Otherwise, there is a risk of electric shock/short circuit!

1. Space the two keyhole openings (7) in the wall where you would like to mount the Cinebar Pro at a distance of 60 cm apart. Use a ruler, pencil and spirit level for this.
2. Use a metal detector to check the drill areas. If necessary, select another area for mounting.
3. Use an 8 mm rock drill to drill holes, which are approx. 50 mm deep, at the marked positions.
4. Insert 2 dowels (\varnothing 8 mm) all the way in the drill holes.
5. Screw one screw (5 x 45 mm) into each dowel until there is approx. 3–5 mm of space between the wall and the screw head.

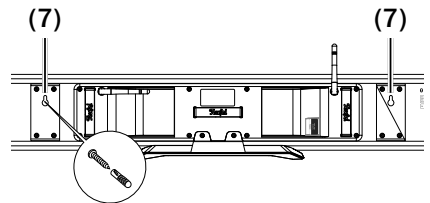

6. Press the Cinebar Pro up against the wall so that the screws vanish in the keyhole openings (7).
7. Now pull the Cinebar Pro down so that the screws slip into the small slot.
8. If applicable, screw the screws further in or out until the Cinebar Pro is securely mounted on the wall.

Connecting

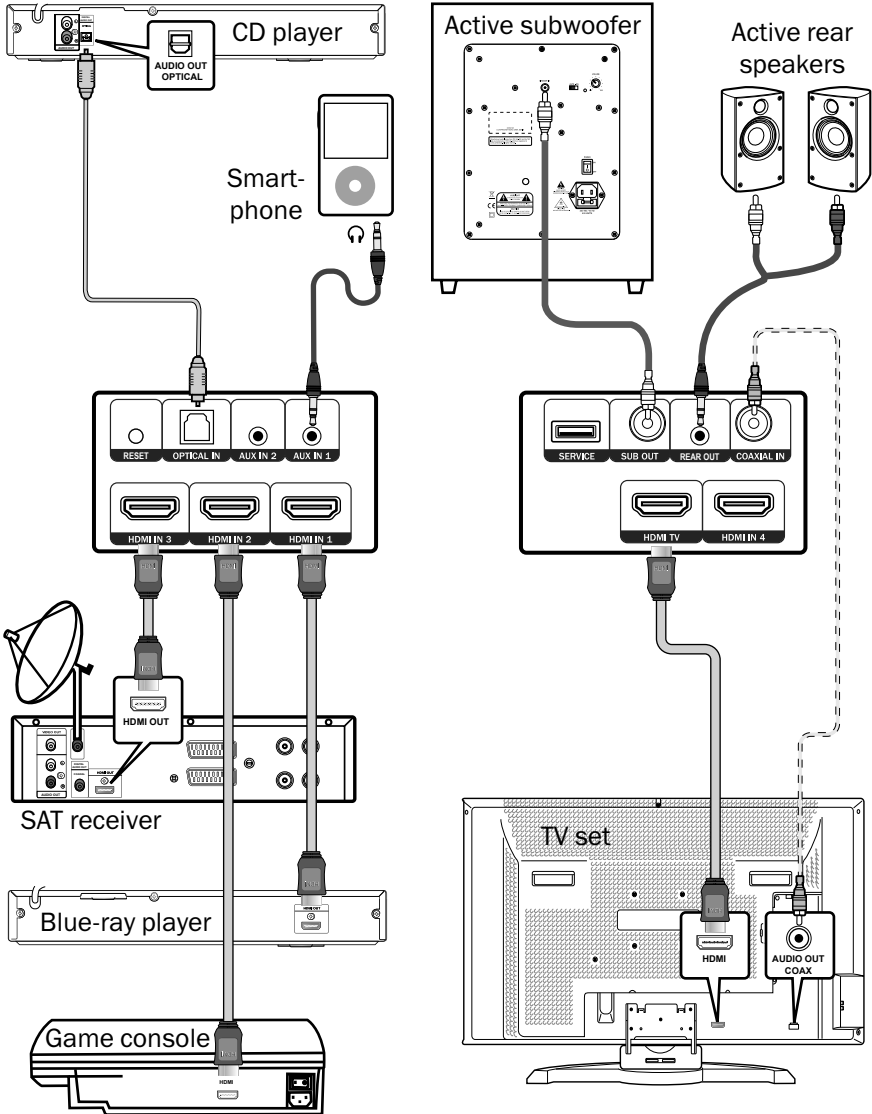

⚠ CAUTION

Risk of injury/damage!

- Lay the cables so that they do not pose a tripping hazard.

TV set

If your TV is equipped with an ARC capable HDMI jack, connect it via the HDMI TV jack (14). You will need an ARC capable HDMI cable for this.

The ARC (audio return channel) HDMI function plays the television audio via HDMI. With some TV sets, this function must be activated in the menu and in most cases, only one HDMI connection is ARC capable (see the user manual for the TV set).

If your TV set does not support the ARC HDMI function, you can also connect it to the analogue (AUX IN (12)) or one of the digital (OPTICAL IN (11)/COAXIAL IN (18)) inputs. Use the remote control to set the inputs to be used in the menu (see „TV Source“ on page 25).

HDMI source

You can connect a source device with digital sound and picture to each HDMI IN 1-4 jack (13) (e.g. a sat receiver, Blu ray player, game console).

You do not also have to connect this source device to your TV set. The video signal from these devices is looped through and forwarded to the television set via HDMI TV (14).

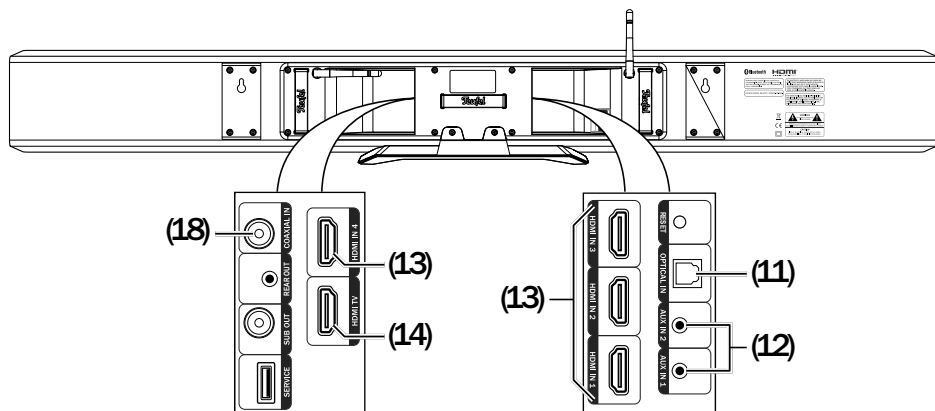

Analogue source

You can connect a source device with analogue sound (e.g. a CD player or TV set) to each AUX IN 1/2 jack (12). For each jack, you will need a stereo cable with a 3.5-mm jack plug to do so.

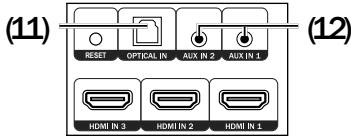

Optical-digital source

You can connect the optical digital sound output of a source device to the OPTICAL IN jack (11). You will need an optical cable with a TOSLINK plug for this. Your source device requires either an optical 3.5 mm plug or also a TOSLINK plug.

Coaxial digital source

You can connect the coaxial digital audio outputs of a source device to the COAXIAL IN jack (18). You will need a coaxial cable with RCA plugs to do so.

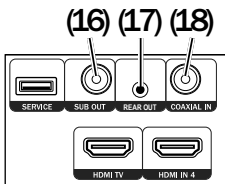

Rear speakers

For 4.1 or 4.0 operation, connect the rear channels (rear) to the analogue output LINE OUT (17).

You can connect a power amplifier or active speaker but also a radio transmission system to this jack. You will need a stereo cable with a 3.5-mm jack plug to do so.

If you use active speakers with a radio connection (e.g. "Effect"), enable the connection in the "Wireless" menu (see page 23).

Subwoofer

You can connect an active subwoofer to the SUB OUT jack (16) using an RCA cable.

If you use an active subwoofer with a radio connection, enable the connection in the "Wireless" menu (see page 24).

Headphones

You can connect stereo headphones to the jack (23) using a 3.5 mm jack plug.

The speakers automatically switch off when headphones are connected.

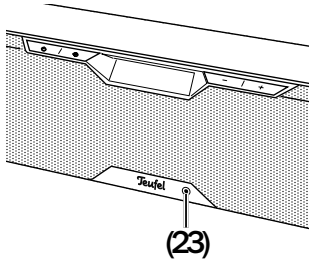

Power supply

1. Insert the small plug of the enclosed mains cord (2) in the POWER jack (9).
2. Connect the mains cord with a mains socket.
The standby display (24) will illuminate in red.

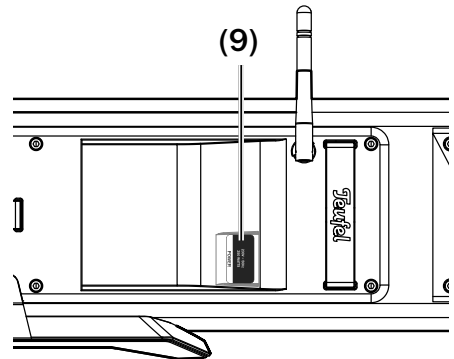
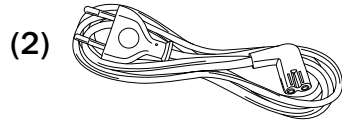

Operation

Activating and deactivating

- Turn the Cinebar Pro on or to standby with the button  (19)/(25).
- After activation, the lettering “TEUFEL” will appear in the text field (21); the last active audio source and volume will be set in the process.
- If the TV set connected via HDMI is compatible with HDMI-CEC, the Cinebar Pro will be activated via the TV set and – providing TV or HDMI IN is selected as the source – also switched off (standby).
- If the Cinebar Pro does not receive an audio signal for more than 20 minutes, it will automatically switch to standby (see also „Auto Off“ on page 25).

Selecting a source

- On the remote control, select the source with the following buttons:

 (30)	Select digital source Bluetooth®
OPTICAL (31)	Select digital source OPTICAL
COAXIAL (32)	Select digital source COAXIAL
HDMI 1-4 (33)	Select HDMI IN 1 to 4 as digital source

TV (46)	Select TV as source via HDMI ARC
AUX 1/2 (45)	Select analogue source AUX IN 1 or 2

- On the Cinebar Pro, select the source by pushing the button  (20) repeatedly.

The selected source will appear in the text field (21).

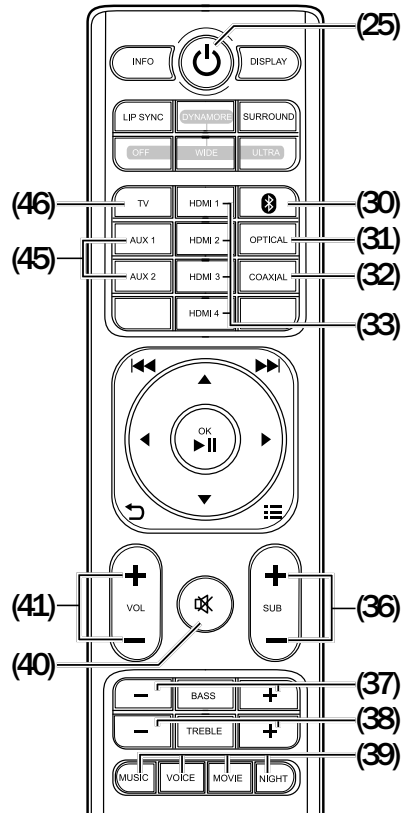

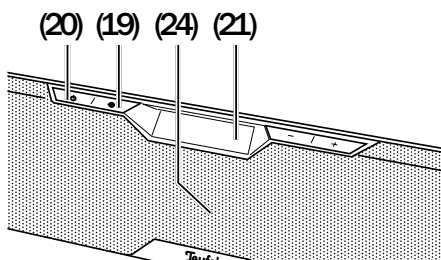

Adjusting the volume

- Push the buttons (22)/(41) to **–** decrease and **+** increase the volume. The current value will appear in the text field (21) while making the setting.
- In HDMI mode, the volume can also be adjusted with the remote control of the TV set (if HDMI CEC is supported by the TV set).

i The volume setting of an external player often affects the volume of the Cinebar Pro.

Mute

- By pushing the button  (40) repeatedly, you can switch the sound off and back on.

Adjusting the volume of the subwoofer

If you have connected a subwoofer, adjust its relative volume with the SUB +/- buttons (36).

This setting is identical to the “Cannel Subwoofer Level” menu item.

Adjusting the sound

You can adjust the sound in two ranges:

- **BASS** – low tones, set with the BASS –/+ buttons (37).
 - **TREBLE** – high tones, set with the TREBLE –/+ buttons (38).
- When choosing a setting, you can see the set value within a range of –10 to 10 in the text field (21).
- The device will return to normal operation after three seconds of button inactivity.

Equalizer

Use the buttons (39) to select the four predefined sound patterns:

MOVIE

Movie sound: Dynamics and bass will be increased.

VOICE

Clear sound for messages and magazines: Bass tones reduced, midtones raised.

MUSIC

Balanced sound across all frequency bands.

NIGHT

Low frequencies and the overall level are weakened to avoid disrupting the sleep of uninvolved persons as much as possible.

Flat

An unchanged sound is selected by pushing the recently used sound button again, as long as the sound mode is still visible on the display.

Stereo widening

DYNAMORE® is a technique that makes the distance between the front speakers sound wider. This generates an impressive, spatial and wide-ranging sound.

- With the buttons (29), you can select the normal (WIDE) or strong (ULTRA) effect. OFF switches stereo widening off.
- Push the DYNAMORE button (27) to have the set surround sound shown in the text field (21).

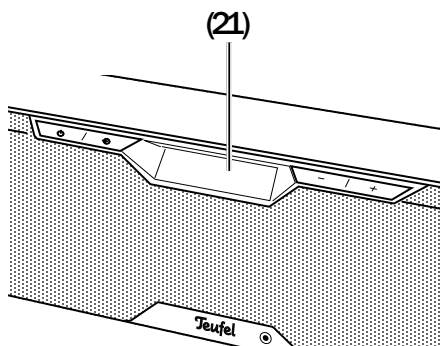

Dolby Audio and Dolby mode

When playing back Dolby Audio DD or DTS encoded multi-channel tracks, the message “DOLBY AUDIO DD”, “Dolby Audio 2.0” or “DTS 5.1” will light up in the text field for three seconds.

- If you push the INFO button (48), the text field (21) will display the set source and the current format (DOLBY AUDIO DD, DTS, PCM).
- By pushing the SURROUND button (28), you will switch between 2.1CH (that is, only the Cinebar Pro and a subwoofer), 4.1CH (4-channel stereo, with additional rear speakers) and Dolby Pro Logic II (see „Dolby Pro Logic II“ on page 23).



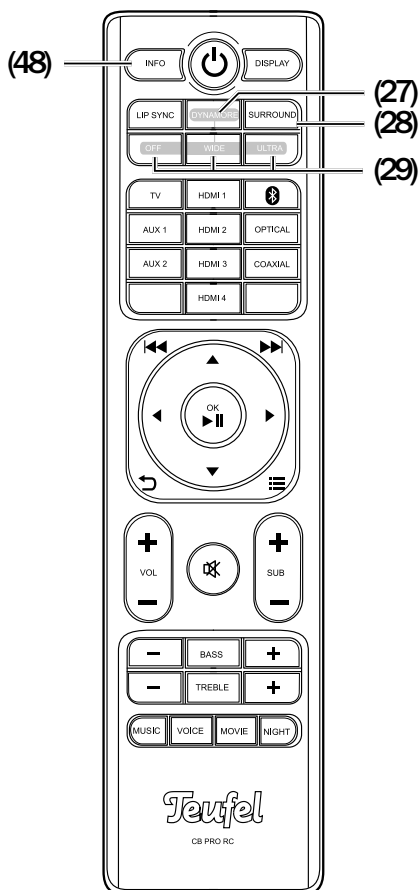





Depending on the input signal, a downmix or upmix (Dolby Pro Logic II) will occur – see „Configuration“ on page 22.



Menu

Some functions of your Cinebar Pro are configured via the menu. You control the menu with the remote control and data is displayed in the text field (21) and on the connected TV set (easier to read).

To use the menu:

1. Push the button  (35).
The first menu item “MENU SPEAKER” will appear in the text field (21).
The complete menu will appear on the TV set.
2. Select the desired submenu item with the navigation buttons  (43).
3. Open the sub-menu with the navigation button  (43) or the OK button (34).
4. Select the desired menu item with the navigation buttons   (43).
5. Set the desired value with the navigation buttons   (43).
6. With the button  (42), you can access the previous menu or exit the menu.
 - The device will return to normal operation after 60 seconds of button inactivity.
 - The menu will always be displayed in English in the text field (21).
 - If the menu on the TV set appears in German, select the submenu “SYSTEM SETUP” and switch the menu item “Language” to “English”.

The following submenus are available and are described below:

- SPEAKER
- SURROUND
- WIRELESS
- SETTINGS

SPEAKER SETUP

Configuration

With this, you will switch between 2.1CH (that is, only the Cinebar Pro and a subwoofer) and 4.1CH (with two additional rear speakers).

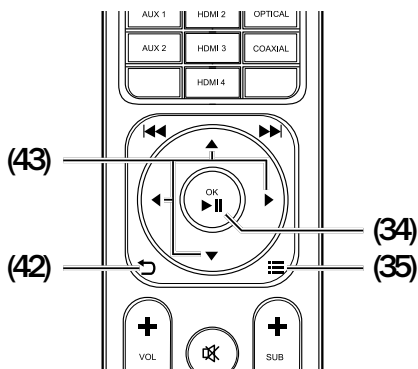
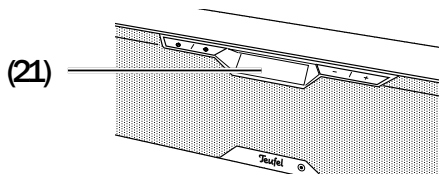

Depending on the input signal, the following occurs automatically: a downmix from multi-channel sound to a 2.1 signal with “2.1CH”, an upmix from stereo sound to 4-channel stereo with “4.1CH” and an upmix from stereo sound to Dolby Pro Logic II surround sound with “Dolby Pro Logic II”.

Distance Sub

Distance Rear Left

Distance Rear Right

Speakers located at different distances to the listening position may disturb the surround sound effect. Here, you can set a slight delay of the signal to compensate these run time differences for all channels. Measure the distance from the listening position to the speakers and enter these values in the respective menu. The system calculates the required delays on this basis. Possible values: 0–12 m.

Channel Level Subwoofer

Channel Level Rear Left

Channel Level Rear Right

Here, you can set the relative volume within a range from “–10 dB” (decrease) to “+10 dB” (increase) for each speaker.

We recommend that you use a sound level meter to optimally adjust the sound level.

Phase Sub

You can hereby switch the phase shift (180°) on and off for the subwoofer. Select the setting, with which the subwoofer produces the loudest and clearest sound.

Test Tone

With the “Test tone”, you can activate and deactivate noise as a neutral test tone and also set the speaker levels as described above.

SURROUND

Dolby Pro Logic II

With this, you can switch the Dolby Prologic decoding on or off while playing back stereo signals.

The setting has no effect with DD and DTS multi-channel signals.

Dynamore

As described under „Stereo widening“ on page 21, you can set the effect here: Off, Wide, Ultra.

Distance Soundbar

For Dynamore, set the distance between your listening position and the Cinebar Pro here: 0–12 m.

Distance Left Wall, distance Right Wall

For Dynamore, set the distance between the Cinebar Pro and the walls on the left and right here: 0–12 m each.

WIRELESS

Wireless Status

You can operate the Cinebar Pro with a compatible wireless subwoofer and wireless rear speakers. For this, pair the devices:

1. Select this menu item and push the OK button **(34)**.
The notice "PAIRING" appears in the text field **(21)** – now, the Cinebar Pro will scan for a wireless subwoofer for approx. 30 seconds.
2. On your wireless speakers, start the process to establish a connection with their "Pairing" buttons (see the corresponding user manuals).
 - The connection will have been established after a short time and the designations of the connected wireless speakers will appear in the text field.
 - If "Search" appears instead, no connection has been established. Repeat the process.

Bluetooth status

Indicates the status of the Bluetooth® connection:

"Not connected" – No device is paired.

"Connected" – an active connection exists.

Pushing the OK button **(34)** ends any active connection and starts a new pairing operation. The message "PAIRING" will appear in the text field and the message "Ready to connect"

will appear on the TV set. Then start the connection process to your Bluetooth® source (also see „Bluetooth® Mode“ on page 28).

Bluetooth® Device Name

(will be displayed on the TV set only)

The name of the external player is displayed here when the connection is active.

WiFi Status

(will be displayed on the TV set only)

Displays the status of the WiFi connection:

"Connected/Not connected"

The WiFi connection is established and controlled with the Chromecast app (see „Google Chromecast“ on page 27).

WiFi RSSI

(will be displayed on the TV set only)

The "Received Signal Strength Indicator" (RSSI) shows the reception level of the WiFi connection.

WiFi SSID

(will be displayed on the TV set only)

The "Service Set Identifier" (SSID) is the name of the base station, to which a WiFi connection exists.

WiFi IP address

(will be displayed on the TV set only)

The IP address of the Cinebar Pro assigned by the base station.

SYSTEM SETUP

HDMI CEC

This option allows you to switch the HDMI function CEC ON and OFF.

With CEC, you can control the Cinebar Pro with the remote control of the TV set via the HDMI connection (activation and deactivation, adjustment of the volume, automatic switching between sources). For this, the TV set must support CEC.

TV Source

If your TV set does not emit the television audio via HDMI ARC, you can select another audio input here. If you then select "TV" as source, the Cinebar Pro will switch to this input:

- HDMI TV – normal input for ARC capable TV sets. PCM Stereo, Dolby Digital and DTS (if this can be output by the TV set) possible.
- AUX1/2 – for TV sets with an analogue audio output or headphone jack. Only analogue signal possible, with or without Dolby Pro Logic II.
- OPT/COAX – for TV sets with an optical or coaxial-digital output. PCM and Dolby or DTS possible.

HDMI Passthrough

If you switch to standby from HDMI mode, an input signal at the HDMI IN jacks 1–4 (13) will either be transmitted to the HDMI output or blocked depending on the setting.

- "On" – signal is transmitted in standby.
- "Off" – signal is blocked.

LipSync

(lip syncing)

Digital image processing in the television set requires some time. To ensure that the picture and sound stay in sync, you can configure an audio delay here between 0 and 250 ms.

Display Fade-out

Sets the brightness of the text field (21):

- "On" – normally dimmed, only lights up during operation.
- "Off" – always lights up with the set value (see „Brightness of the text field“ on page 26).

Wireless Wakeup

If the Cinebar Pro is in standby, you can switch it on with the last Chromecast device paired by simply restoring the connection there.

. You switch this function "On" or "Off" this way.

Auto Off

After a certain configurable period of inactivity, the Cinebar Pro will automatically switch to standby. Possible values: Never, 20 minutes, 40 minutes.

Language

Set the language for the screen menu. German or English.

System Reset

This clears all modified settings:

- Push the OK button (34).
The message “Confirm system reset” will appear on the TV-set.
- Push the button ↶ (42) to abort.
- Push the OK button (34) to clear.
The Cinebar Pro will restore the factory default settings. In the process, all wireless connections will be interrupted.

Firmware version

(will be displayed on the TV set only)

Based on the version shown here (e.g. “5.3”), you can determine whether new system software is available on our website www.teufelaudio.com/software-updates.html

(see „Software Update“ on page 30).

Google Cast firmware version

(will be displayed on the TV set only)

Displays the version of the Google Chromecast firmware.

Other settings

Brightness of the text field

With the DISPLAY button (26), you can adjust the brightness of the text field (21):

- BRIGHT
- DARK
- OFF

When operating the device, the text field lights up completely and, after a few seconds, dims back to the value set here.

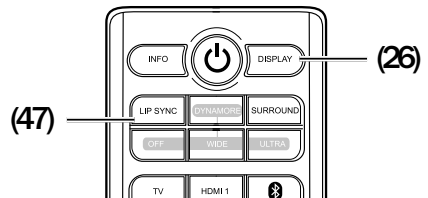

LipSync (lip syncing)

Digital image processing in the television set requires some time. To ensure that the picture and sound stay in sync, you can set an audio delay between 0 and 250 ms with the LIP SYNC button (47).

After pushing the button, you can set the desired value with the VOL +/- button (41).

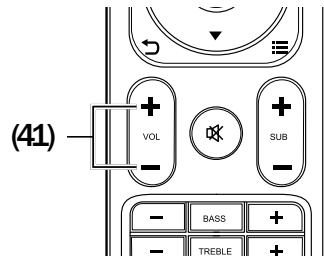

This function is identical to the “LipSync” menu item from the “Settings” menu.

Google Chromecast

The built-in Chromecast technology is a procedure developed by Google for the wireless transmission of media data to playback devices.

You can find more information on the website of Google:

https://www.google.com/intl/de_de/chromecast/built-in/

The Cinebar Pro can receive audio data via Chromecast.

Prerequisite: WiFi connection.

Configuration

The Google Home app, which you can download here for Android and IOS, handles the setup process:

Google Play Store (Android):

<https://play.google.com/store/apps/details?id=com.google.android.apps.chromecast.app&hl=de>

App Store (IOS):

<https://itunes.apple.com/us/app/google-home/id680819774?mt=8>

The app automatically sets up the WiFi connection to the Cinebar Pro. You can then play back audio data via the Cinebar Pro with Chromecast programmes.

You can find more information about configuring Chromecast under the following link:

<https://support.google.com/chromecast/answer/2998456?co=GENIE.Platform%3DAndroid&hl=de>

Spotify CONNECT

Use your phone, tablet or computer as a remote control for Spotify.

Go to spotify.com/connect to learn how

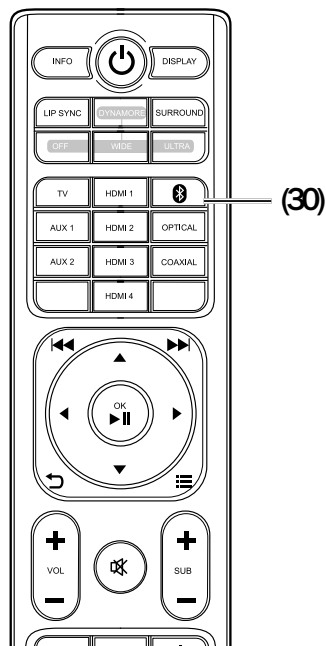

Bluetooth® Mode

Via Bluetooth®, you can establish a wireless connection between a compatible external player and the Cinebar Pro. The audio output of your external player is then emitted by the Cinebar Pro.

The Bluetooth® wireless transmission system has a range of approximately 10 metres that is limited by walls and furnishings. If the connection is cut off, the Cinebar Pro will attempt to re-establish a connection until you select another source.

NOTICE



- *Only use the Bluetooth® function in locations where wireless radio transmission is allowed.*
- *Please keep in mind that the Bluetooth® behaviour may differ depending on the external player's operating system.*

Bluetooth® options

Depending on the device type, your external player/smartphone may also have a menu for Bluetooth® options such as media playback. Here you can activate and deactivate the desired options. You can find more information about the Bluetooth® options in the user manual for your external player/smartphone.

Pairing and connecting

To play the audio of your external player on your Cinebar Pro via Bluetooth®, connect the devices with each other. This is called “Pairing”.

1. Turn on the Bluetooth® function on your external player (e.g. smartphone).
2. Use the  button (30) to select the “Bluetooth” input on the Cinebar Pro.
3. Push the button  (30) again and hold it down for approx. 3 seconds to start the pairing process. The message “PAIRING” will appear in the text field.
4. Let your external player/smartphone scan for Bluetooth® devices. You will find more information about this in the user manual of your external player. After the search run, the “Cinebar Pro” should also be present in the list of detected devices.
5. Select “Cinebar Pro” from the list of detected devices.
6. If your external player asks for a code, enter “0000” (four zeros).
Pairing is now complete. “BT” appears in the text field and your Cinebar Pro will now act as a Bluetooth® playback device. The Cinebar Pro will now play back all sounds that would otherwise be played by your external player/smartphone.

Playback

 The volume setting of the external player affects the volume of the Cinebar Pro.

1. Use the  button (30) to select Bluetooth® as the source.
2. Turn on the Bluetooth® function on your source device.
3. Start playback on your source device.

You can control playback on your source device. You can also control some functions with the remote control of the Cinebar Pro:

- Pause playback: Push the OK/▶|| button (34).
- Continue playback: Push the ▶|| button (34) again.
- Play next track: Tap the ▶▶ button (44).
- Restart the current track: Tap the ◀◀ button (44).
- Play previous track: Tap the ◀◀ button (44) twice.
- If your source device is a smart-phone, the Bluetooth® connection will be interrupted in the event of an incoming call and you can make phone calls as usual. After finishing your phone call, the sounds will once again be diverted and played back by your Cinebar Pro.

Interruption of connection

If your external player moves out of the range of your Cinebar Pro, the Bluetooth® connection will be interrupted. If you are back within range within 120 seconds, the connection will be re-established automatically.

Terminating the connection

To terminate the Bluetooth® connection,

- deactivate the Bluetooth® function on your external player/smart-phone.
- select another source on the Cinebar Pro.

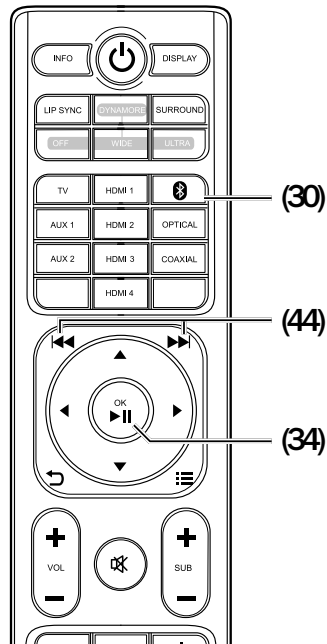

Software Update

The software of the Cinebar Pro is being continually developed. You can load subsequent versions from our website:

www.teufel.com/software-updates.html

Installing new software

Load the new software from our website.

1. Unpack the downloaded file and save it to a USB stick (FAT32 format).
2. Pull the mains plug of the Cinebar Pro out of the socket.

NOTICE

Risk of damage!

– *The Cinebar Pro must not be turned off while the following steps are being performed!*

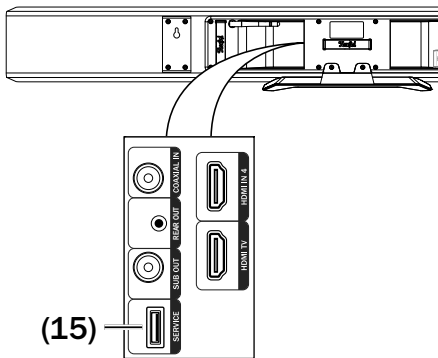

3. Insert the USB stick in the SERVICE jack (15).
4. Connect the Cinebar Pro with the socket again.

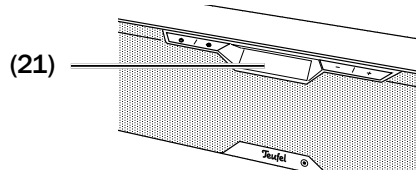

“ERASE” will appear in the text field (21) and the update will run in multiple phases.

5. When the update is complete, pull the USB stick out of the SERVICE jack (15).

The new software is now installed.

Care And Cleaning

NOTICE

External influences may damage or destroy the device.

- *If the device is to be left unattended for a prolonged period of time (e.g. during a vacation) or if a thunderstorm is forecast, pull the mains plug out of the socket. Otherwise, sudden overvoltage could cause the device to become defective.*
 - *In the event of prolonged absence, remove the batteries from the remote control. Leaked batteries may damage the remote control.*
 - *If possible, only use plain water without any additives. In case of stubborn marks, a mild soap solution may be used.*
 - *Do not use caustic cleaning products, white spirit, thinners, petrol or similar under any circumstances. Such cleaning agents may damage the delicate surface of the housing.*
- Ideally, you should remove dust or small amounts of dirt with a dry, smooth leather cloth.
 - Use a damp cloth to rub off stubborn dirt. Make sure that no liquid penetrates the housing.
 - Then immediately wipe the damp surfaces off with a soft cloth without applying pressure.

Troubleshooting

The following advice should help you to solve problems. If this does not help, you will find useful information in the detailed FAQs on our website. Otherwise, please contact our hotline (see page 4). Take note of the warranty instructions.

Problem	Possible cause	Solution
No function.	No power supply.	Check the function of the socket with another device.
	The small plug of the mains adapter has slipped out.	Check the connection of the mains adapter (page 18).
The device doesn't emit any sound.	The wrong source has been selected.	Select the right source (page 19).
	The device is set to "mute".	Push the  (40) button or adjust the volume.
	The volume is set to "0".	Increase the volume.
	The volume of the external player has been set too low.	Carefully increase the volume of the external player.
No sound during TV playback	The ARC function on the TV is not activated.	Switch ARC on in the menu of the TV.
	HDMI jack on the TV does not support the ARC function.	Use the jack supporting the ARC function on the TV.
	HDMI cable without ARC function.	Use a suitable HDMI cable.
No sound with Bluetooth®.	No Bluetooth® connection.	Establish a connection (see page 28).
	Cinebar Pro has not been selected as the output device.	On the external player, select "Cinebar Pro" as the Bluetooth® output device.
	Bluetooth® connection impaired by another radio system (e.g. cordless telephone, Wi-Fi).	Set up the Cinebar Pro and/or external player in another location. Move to another room to test.

No connection to Google Cast.	Google Home app is not installed	Install the Google Home app (see „Google Chromecast“ on page 27).
The wireless subwoofer doesn't work.	The subwoofer is off or doesn't have any power.	Switch the subwoofer on. Check the mains cord and socket.
	No wireless connection.	Establish a connection (see „Wireless Status“ on page 24).
The subwoofer hums.	The hum is due to line disturbance.	Buy a mains filter and connect both devices to it.
	The humming is caused by a multiple socket strip.	Use a different multiple socket strip or connect the subwoofer directly to the wall socket. It may also help to insert the mains plug in the socket the other way around.
Playback is noisy.	Generally speaking, the Cinebar Pro is a very low-noise system. The speaker system with very high resolution in the high range area can expose the poor quality of a signal source (e.g. from MP3 files).	Ensure that the source is sending a clear signal to the Cinebar Pro.

Technical Data

Dimensions (W × H × D)	1200 × 147 × 138 mm
Weight	11.2 kg
Operating voltage	230 V~, 50 Hz, 250 W max.

You can find further technical data on our website. Technical changes reserved!

Declaration Of Conformity



Lautsprecher Teufel GmbH declares that this product complies with Directive 2014/53/EU. The full text of the EU Declaration of Conformity can be found at this web address:

www.teufel.de/konformitaetserklaerungen

www.teufelaudio.com/declaration-of-conformity

The following radio frequency bands and radio transmitting powers are used in this product:

Radio network	Frequency bands in MHz	Transmission power in mW/ dBm
Bluetooth®	2,400–2,483.5	2.5/4
Wireless subwoofer	2,405–2,477	1/0
WiFi/WLAN	2,412-2,472	40/16
	5,180-5,320	25/14
	5,500-5,700	25/14
	5,745-5,825	25/14

Disposal

Important information in accordance with the Electrical and Electronic Equipment Act (Germany: ElektroG)

We advise owners of electrical and electronic appliances that old electrical and electronic devices must be handed in separately from municipal waste, in accordance with the applicable regulations. Batteries and rechargeable batteries that are not firmly enclosed in old electrical devices and lamps, and that can be removed from the old device without destroying them, must be separated from them in a non-destructive manner before they are handed to the collection point for their intended disposal. Please take note of our information on the Batteries Act [Germany: BattG] below for disposing of batteries.

You make an important contribution to returning, recycling and further processing of old devices if you separate your old devices into the correct collection groups for recycling.

The symbol below of a crossed-out dustbin, applied to electrical and electronic appliances, also advises of the duty to separate collections:



Consumer electronics stores and supermarkets are obliged, under certain conditions, to take back old electrical and electronic devices, in accordance with section 17 of the Electrical and Electronic Equipment Act. Stationary retailers must take back an old electrical device of the same type when a new electrical device is bought (1:1 return). This also applies to home deliveries. These retailers must also take back up to three small old electrical devices ($\leq 25\text{cm}$) without this being linked to a new purchase (0:1 return).

In accordance with the Electrical and Electronic Equipment Act, as online retailers of electrical devices and due to our product range, our obligation is limited to 1:1 return of large devices of $> 50\text{ cm}$ when selling a new electrical or electronic device of the same type. We comply with the obligation of return of devices other than large devices through our service provider. You can find the exact contact data and collection points on our website www.Teufel.de/entsorgung. It is also possible to return old electrical and electronic appliances free of charge at an official delivery point run by the public waste disposal authorities.

Important: For safety reasons we ask that you refrain from sending lighting fixtures (some lamps). For return of lighting fixtures please use the public waste disposal collection points or contact us directly at www.Teufel.de/entsorgung.

As an end-user, you are responsible for deleting any personal data on old electrical appliances before handing it in.

Important: Our appliances can contain batteries/rechargeable batteries. If this is the case, please refer to its attached product documentation for additional information on the type and chemical make-up of the battery. For products with battery compartments you can directly remove the batteries or rechargeable batteries and dispose of them properly. If the batteries are built in to the product, do not in any case attempt to remove the batteries yourself, instead contact one of our employees or appropriate specialist staff.

Important information about the Batteries Act (Germany: BattG)

Batteries and rechargeable batteries must not be disposed on in household waste.

Old batteries can contain toxic substances that could damage the environment or your health if not stored or disposed of properly. This applies especially to improper handling of batteries containing lithium.

However, batteries also contain important raw materials such as iron, zinc, manganese and nickel and these can be reused. Separate collection enables recycling of these raw materials and avoids any negative impact on the environment or human health due to toxic substances being released.



The crossed-out dustbin symbol means that you should not dispose of old batteries and rechargeable batteries in household waste. In addition, you, as the end-user, are legally obliged to return old batteries.

You can hand in batteries and rechargeable batteries free of charge at an official return point such as any public waste disposal collection point. You can also hand in old batteries, that we stock or have stocked as new batteries, at one of our Teufel stores or at one of our dispatch warehouses. However, if you send them to our dispatch warehouses we would like to point out the dangerous goods regulations of the dispatch provider you opt for and ask you not send batteries to us by post. You can get the addresses of our dispatch warehouses from our customer service.

Due to existing legal regulations, the battery manufacturer must use the following symbols with the following meanings when marking the batteries.

Hg: the battery contains more than
0.0005 mass percent of mercury

Pb: the battery contains more than
0.004 mass percent of lead

Cd: the battery contains more than
0.002 mass percent of cadmium

Otherwise, to avoid waste and littering, batteries with a long service life or rechargeable batteries should be used. Exchangeable rechargeable batteries enable long service for electrical and electronic appliances and thus devices and rechargeable batteries can be prepared for recycling (e.g. regenerating/exchanging rechargeable batteries).

Further information on preventing waste for consumers can, however, be found in the Federal waste prevention programme with the participation of the Federal states.

Teufel

Please contact our customer service department with any questions, suggestions, or complaints:

Lautsprecher Teufel GmbH
BIKINI Berlin, Budapester Straße 44
10787 Berlin (Germany)
www.teufelaudio.com

Phone: 00800 200 300 40 (toll-free)

Fax: +49 (0)30 - 300 930 930

Online-support:
www.teufelaudio.com/service

Contact:
www.teufelaudio.com/contact

No responsibility is assumed for the correctness of this information.
Technical changes, typographical errors and other errors reserved.