

Technical Description And User Manual

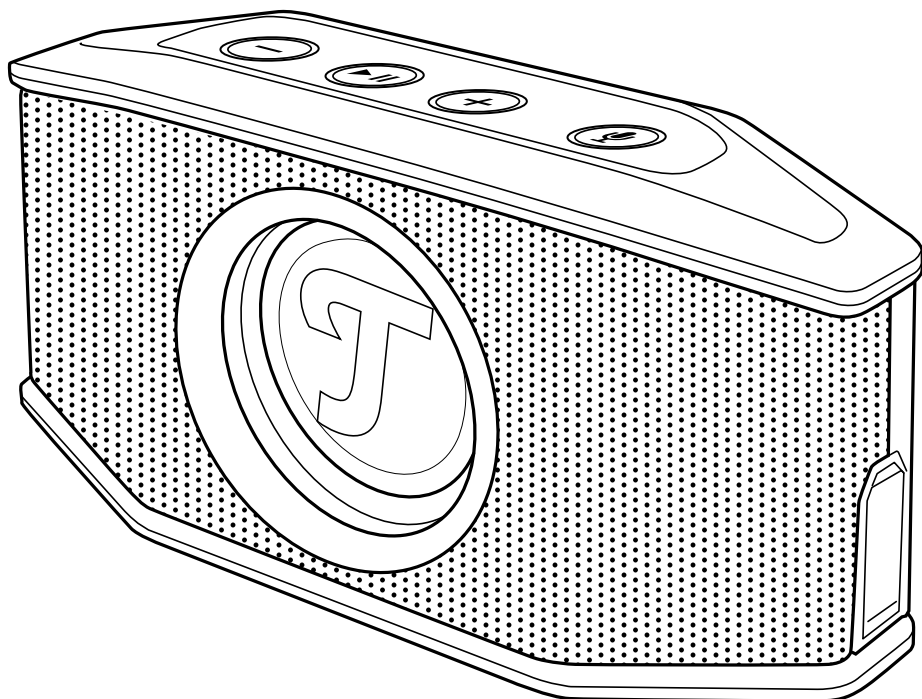

ROCKSTER GO

Water-resistant active Bluetooth® speaker with PC sound card function and control for smartphone voice assistant

Teufel

Contents

General Notes And Information.....	3	Operation	14
Notice	3	Activating and deactivating.....	15
Trademarks	3	Volume.....	15
Original packaging	3	Bluetooth®	16
Complaints	4	AUX	18
Contact.....	4	Connect mode.....	19
For Your Safety	5	PC sound card.....	20
Proper use	5	Care And Cleaning.....	22
Signal terms	5	Troubleshooting.....	23
Safety notes	5	Technical Data.....	24
Unpacking.....	9	Declaration Of Conformity	24
Package contents	9	Disposal.....	25
Controls And Connections	10	Important information in accordance with the Electrical and Electronic Equipment Act (Germany: ElektroG).....	25
The Rechargeable Battery	11	Important information about the Batteries Act (Germany: BattG)	26
Charging the Rechargeable Battery.....	11		
Charge level of the rechargeable battery	11		
Setup.....	13		
Location tips.....	13		
PA tripod	13		
Carrying strap.....	13		

General Notes And Information

Notice

The information in this document may change without prior notice and in no way constitutes any liability on the part of Lautsprecher Teufel GmbH.

No part of this user manual may be reproduced in any form or be broadcasted in any way electronically, mechanically, by photocopy or recording without the written permission of Lautsprecher Teufel GmbH.

© Lautsprecher Teufel GmbH

Version 2.1

October 2022

Trademarks

© All trademarks are the property of their respective owners.

 **Bluetooth**[®] The Bluetooth[®] word mark and Bluetooth[®] symbol are registered trademarks of Bluetooth SIG, Inc. and any use by Lautsprecher Teufel is licensed.

Qualcomm[®] aptX[™]

Qualcomm aptX is a product of Qualcomm Technologies International, Ltd.

Qualcomm is a trademark of Qualcomm Incorporated, registered in the USA and other countries, whose use has been approved.

aptX is a trademark of Qualcomm Technologies International, Ltd., registered in the USA and other countries, whose use has been approved.

Original packaging

If you wish to exercise your right of return, we ask that you be absolutely sure to hold on to the packaging. We can only accept the return of the speakers WITH THE ORIGINAL PACKAGING.

Empty boxes are not available!

Complaints

In case of a complaint we will need the following information to process your enquiry:

1. Invoice number

Can be found on the sales slip (enclosed with the product) or on the order confirmation received as a PDF document, e.g. 4322543

2. Serial number or batch number

Located on the bottom of the device, e.g. serial no.: KB20240129A-123.

Thank you for your support!

Contact

Please contact our customer service department with any questions, suggestions, or complaints:

Lautsprecher Teufel GmbH
BIKINI Berlin
Budapester Straße 44
10787 Berlin (Germany)

Phone:

00800 200 300 40 (toll-free)

Fax: +4930 300 930 930

Online support:

www.teufelaudio.com/service

Contact form:

www.teufelaudio.com/contact

For Your Safety

Proper use

The splash-proof speaker is designed for the playback of music and speech from an external player via Bluetooth® or cable.

Only use the speaker as described in this user manual. Any other use will be deemed as not in accordance with the instructions and may lead to damage to property or even persons.

The manufacturer accepts no liability for damage caused by improper use.

The speaker is intended for private use.



Before operating the speaker, please read the safety notes and user manual carefully.

Only in this way, you can ensure that all functions are used in a safe and reliable manner. Store the user manual in a safe place and also be sure to pass it on to any subsequent owner.

Signal terms

You can find the following signal terms in this user manual:

WARNING

This signal term indicates a moderate risk, which, if not avoided, may result in death or severe injury.

CAUTION

This signal term indicates a low risk, which, if not avoided, may result in minor or moderate injury.

NOTICE

This signal term warns you of potential damage.

Safety notes

This chapter contains general safety notes which you should always observe to protect yourself and third parties. Also observe the warning notes in each chapter of this user manual.

WARNING

Touching live parts can result in severe injury or death.

- *When connecting the device, make sure that the correct voltage is present. You can find more information about this on the rating plate.*

- Check the device regularly for damage. Immediately disconnect the mains plug and do not operate the device if its housing or mains cord is defective or exhibits other visible damages.
- This device can only be completely disconnected from the grid by pulling the USB charger. Thus, make sure that the mains plug is always easily accessible.
- If the device emits smoke, smells burnt or produces unusual sounds, immediately disconnect it from the mains and do not operate it further.
- Never open the device housing. Repairs of the device may only be carried out by an authorised specialist workshop. Only parts that match the original specifications may be used.
- Only use the accessory products specified by the manufacturer.
- Never modify the device. Unauthorised modifications may affect the safety and functionality.

⚠ WARNING

An unsuitable setup location may result in injury and damage.

- If the speaker is not securely mounted, do not use it in vehicles, in unstable locations, on wobbly tripods or furniture, on underdimensioned brackets etc. The speaker may tip or fall over and cause injury to persons or be damaged itself.

- Position the speaker in such a way that it cannot be knocked over inadvertently and make sure that the cables do not pose a tripping hazard.
- Do not use the device in environments where there is a risk of explosion.
- Only use the Bluetooth® function in locations where wireless radio transmission is allowed.

⚠ WARNING

Children can become trapped in the packaging film when playing and suffocate.

- Do not allow children to play with the device or the plastic wrapping. There is a danger of suffocation.
- Never allow children to operate electrical equipment unsupervised.

⚠ WARNING

Lithium rechargeable batteries can explode if handled improperly.

- You must not heat or short circuit rechargeable batteries or dispose of them in fire.
- Do not expose the rechargeable batteries to direct sunlight.
- Do not place the speakers near heat sources (e.g. heaters, ovens, other heat generating equipment such as amplifiers etc.).

⚠ CAUTION



Extended listening at high volumes may lead to hearing loss. To avoid

damage to health, avoid extended listening at high volumes.

- When the volume is set high, always keep a certain distance from the device and never place your ears directly on the speaker.
- If a speaker is set to full volume, this may produce very high sound pressure. This may have psychological consequences and also cause physical injury. Children and pets are particularly at risk. Set your signal source device volume control to a low setting before turning on the power.

⚠ CAUTION

Batteries (particularly lithium batteries) can explode if used improperly.

- You must not heat or short circuit rechargeable batteries or dispose of them in fire.
- Do not expose the rechargeable batteries to direct sunlight.

⚠ CAUTION

This product contains magnetic material.

- If necessary, consult your physician and ask for effects on implants such as pacemakers or defibrillators.

NOTICE

The ROCKSTER GO is splash-proof but not watertight!

- The splash-proof protection is only effective if the rubber cap on the USB port seals it off properly.
- Normal rain and a few splashes from showering won't cause any damage, but you should avoid spraying it directly with a hose.
- If the ROCKSTER GO falls into a paddling pool, fish pond or other flat water body, nothing will happen if you recover it right away. However, the device is not suitable for diving!
- You should generally avoid contact with salt water.

NOTICE

Gross misuse and incorrect care are the main reasons for damage to high-performance rechargeable batteries.

- Avoid deep discharge of under 20 % for optimal rechargeable battery power.
- Recharge your rechargeable battery frequently.
- Store your rechargeable battery in a cool, but frost-free area, ideally at 15 °C. Higher temperatures result in a higher rate of self-discharge and shorten the intervals between charges.
- Do not expose the rechargeable battery to direct sunlight or other sources of heat.

- *A deep discharge damages the rechargeable battery cells. The most frequent cause of deep discharge is prolonged storage or failure to use a partially discharged rechargeable battery. Only store the rechargeable battery once it is fully charged.*

Unpacking

Package contents



- (1) ROCKSTER GO
- (2) Charging cable (USB A to Micro B)
- (3) Carrying strap

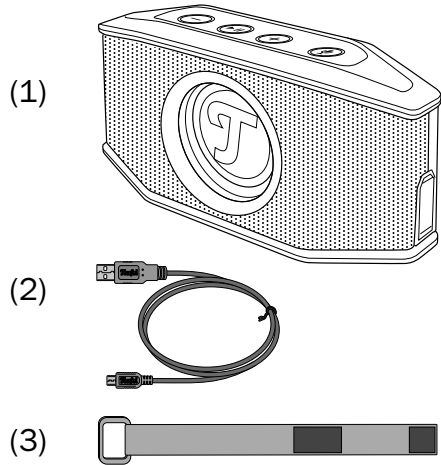

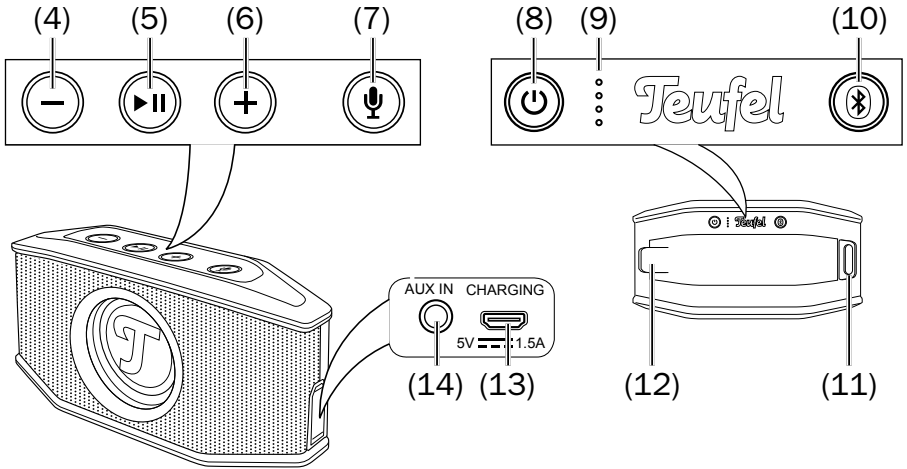

- Check that all items have been delivered and that nothing is damaged. If you find any damage, do not operate the device; instead contact our customer service department (see „Contact“ on page 4).
- Please keep the packaging for the duration of the warranty period.



Controls And Connections



- (4)** – Decrease the volume. Volume control in 30 levels. In case of a phone call: Reject call. In case of BT playback push together with button **(5)**: Skip back.
- (5)** ▶ || Playback/pause. Tap in case of a phone call: Accept call/hang up.
- (6)** + Increase the volume. In case of BT playback push together with button **(5)**: Skip forward.
- (7)** Only with Bluetooth® playback: Tap : Activate the smart-phone's voice assistant. Briefly push  in the event of a phone call: Accept call/hang up.
- (8)** Push and hold  for 2 seconds: Switch the device on.

- Tap  during operation: Display battery charge with LEDs **(9)**.
- Push and hold  for 2 seconds: Switch the device off.
- (9)** LED indicator for charging and rechargeable battery charge level.
- (10)** Push and hold  for 3 seconds: Start Bluetooth® pairing mode. Push and hold  for 10 seconds: Clear all Bluetooth® connections.
- (11)** Loop for carrying strap **(3)**.
- (12)** Hook for carrying strap.
- (13)** USB micro port for an external mains adapter/charger (not included in the package contents) and for a PC sound card.
- (14)** AUX IN, stereo input with a 3.5 mm jack plug socket.

The Rechargeable Battery

Before first use, charge the rechargeable battery for approx. 3 to 4 hours.

Charging the Rechargeable Battery

The integrated Li-Ion rechargeable battery is charged as soon as the ROCKSTER GO is supplied with power from the USB micro port **(13)**.

Four white LEDs on the rechargeable battery indicator **(9)** signalise the charging process:

100%	all 4 LEDs are illuminated
75-99%	3 LEDs are illuminated, 4th is flashing
50-74%	2 LEDs are illuminated, 3rd is flashing
25-49%	1 LED is illuminated, 2nd is flashing
<25%	Bottom LED is flashing

Charge level of the rechargeable battery

You can display the rechargeable battery charge level by tapping the **⏻** button **(8)**:

76-100%	all 4 LEDs are illuminated
51-75%	3 LEDs are illuminated
26-50%	2 LEDs are illuminated
11-25%	1 LED is illuminated
<10%	Bottom LED is flashing

To protect the rechargeable battery, the ROCKSTER GO has deep discharge protection, which switches the device off once the threshold is reached.

i If the rechargeable battery charge diminishes, the ROCKSTER GO will emit two short warning tones several times and the LED at the bottom of the rechargeable battery indicator will blink. Depending on the volume, operation will still be possible for 10–15 minutes. In such a case, promptly connect a USB charger.

⚠ CAUTION

Batteries (particularly lithium batteries) can explode if used improperly.

- You must not heat or short circuit rechargeable batteries or dispose of them in fire.
- Do not expose the rechargeable batteries to direct sunlight.

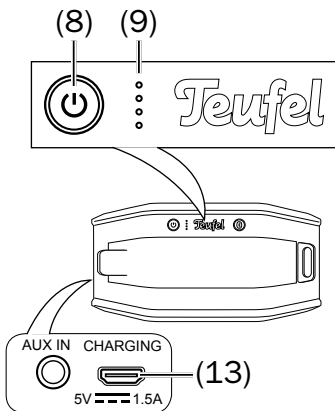

Setup

NOTICE

Listening at very high volumes and playing music with heavy bass may, under certain circumstances, cause the device to move around.

– Therefore, always make sure that the device is in a stable and secure position. The warranty does not cover damages caused by falling or dropping of the device.

Location tips

- Select a stable, level base.
- Select a location away from heat sources and direct sunlight.
- If applicable, lay the connector cords so that they do not pose a tripping hazard.
- Do not place any heavy objects on the ROCKSTER GO.

You can simply place the ROCKSTER GO on a stable, level surface.

PA tripod

A threaded hole (1/4" × 12 mm) with which you can mount the device on a photo or PA tripod is located on the bottom of the ROCKSTER GO.

Carrying strap

You can use the elastic carrying strap (3) to secure the ROCKSTER GO in many places, for example, on a front bike basket or a jeans belt buckle.

1. Push the end of the carrying strap with the hook and loop fastener through the loop (11).
2. Fold the end of the strap so that the hook and loop fasteners extend into one another. The bottom hook and loop fastener is slightly longer so that you can vary the length of the strap.
3. Clamp the strap buckle over the hook (12).

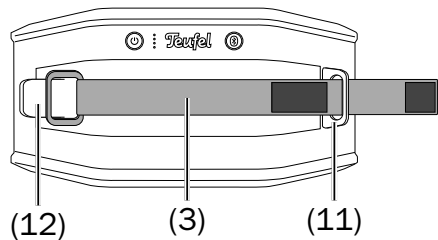

Operation

CAUTION



Extended listening at high volumes may lead to hearing loss.

- To avoid damage to health, avoid extended listening at high volumes.*
- When the volume is set high, always keep a certain distance from the device and never place your ears directly on the speaker.*
- If a speaker is set to full volume, this may produce very high sound pressure. This may have psychological consequences and also cause physical injury. Children and pets are particularly at risk. Set your signal source device volume control to a low setting before turning on the power.*

NOTICE

If the device is subjected to warm temperatures after being cold (e.g. after transport), condensation may occur inside of it.

- In this case, wait at least 2 hours before you connect and activate it.*

Activating and deactivating

Activating

- Push and hold the  button **(8)** for approx. 2 seconds. The ROCKSTER GO will be switched on emitting a signal tone and the ring around the button will illuminate in red.

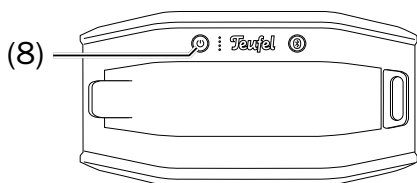

Deactivating

- Push and hold the  button **(8)** for approx. 2 seconds. The ROCKSTER GO will be switched off emitting a signal tone.

Auto off

- After 10 minutes without an input signal, the device will automatically switch to standby. As soon as an input signal is present again or a button is pushed, the ROCKSTER GO will switch back on.
- If operated with power from the integrated rechargeable battery, the ROCKSTER GO will switch to energy-saving mode after an additional 10 minutes and can only be switched back on by pushing the  button **(8)**.

Volume

- With the **(4)** and **(6)** buttons, you can reduce or increase the volume in 32 levels.

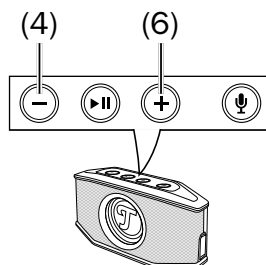

You can gradually adjust the volume by tapping. Pushing and holding will change the volume continuously.

Bluetooth®

Via Bluetooth®, you can establish a wireless connection between a compatible external player and the ROCKSTER GO. The audio output of your external player is then emitted by the ROCKSTER GO.

You can also register two Bluetooth® devices, which are played in alternation.

For smartphones with Android or an IOS operating system, you can also use the voice assistant via the ROCKSTER GO.

NOTICE

Only use the Bluetooth® function in locations where wireless radio transmission is allowed.

Please keep in mind that the Bluetooth® behaviour may differ depending on the external player's operating system.

Bluetooth® options

Depending on the device type, your external player/smartphone may also have a number of Bluetooth® options such as media playback and call function. Here you can activate and deactivate the desired options.

You can find more information about the Bluetooth® options in the user manual for your external player/smartphone.

Pairing

To play the audio of your external player on your ROCKSTER GO via Bluetooth®, you must first connect the devices with each other. This is called "Pairing". The ROCKSTER GO can save data from up to seven external players, which can be subsequently connected to without having to repeat the pairing process.

1. Turn on the Bluetooth® function on your external player (e.g. smartphone).
2. Push the **Ⓜ** button **(10)** and hold it for approximately 3 seconds.

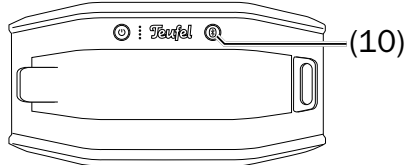

You will hear a short signal tone and the circle around the button will blink in blue.

3. Let your external player/smartphone scan for Bluetooth® devices. You will find more information about this in the user manual of your external player. After the search run, "Teufel ROCKSTER GO" should also be present in the list of detected devices.
4. Select "Teufel ROCKSTER GO" from the list of detected devices. Pairing is now complete and your ROCKSTER GO will now act as a Bluetooth® playback device. The ROCKSTER GO will now play back all sounds that would otherwise be played by your external player/smartphone.

5. If you would like to pair a second external player, repeat steps 1 to 4 with the second device. Then, select the Teufel ROCKSTER GO again from the list of paired devices on the first device. Now, you can use both devices in alternation in party mode (see below).

Playback

i The volume setting of the external player affects the volume of the ROCKSTER GO.

- Start playback on your external player.
- Pause playback:
Briefly push the button ► **II** (5).
- Continue playback:
Briefly push the button ► **II** (5).
- Play the next track:
Tap the buttons ► **II** (5) and + (6) at the same time.
- Play the track from the beginning:
Tap the buttons ► **II** (5) and – (4) at the same time.
- Play the previous track:
Tap the buttons ► **II** (5) and – (4) twice at the same time.

Party mode

If you are using two external players at the same time, you can look for the next track on one device while the other is playing. Once the track is over, push the stop or pause button and start playback on the other device.

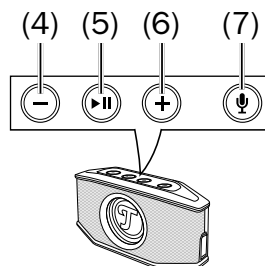

Voice assistants

Prerequisites: Present Bluetooth® connection and voice assistant on the smartphone is enabled.

To activate the assistant, tap the **μ** button (7) and wait until the assistant responds. Then simply speak in the direction of the ROCKSTER GO.

Call function

You can use the ROCKSTER GO as a hands-free device for your smartphone.

- In the event of an incoming call, your smartphone will ring and the ROCKSTER GO will also emit a ring tone. Any media playback will be paused.
- To reject the call, tap the – button (6). The call will be ended and the caller will hear the busy signal.

- To take the call, tap the button **ψ (7)** or **▶ II (5)** on the ROCKSTER GO.
- Now you can answer the call with your ROCKSTER GO via the integrated microphone.
- Push the button **ψ (7)** or **▶ II (5)** again to end the call.

Media playback will resume.

Terminating the Bluetooth® connection

To terminate the Bluetooth® connection, switch the Bluetooth® function on your external player/smartphone off.

- To delete the list of known external players, hold the **ⓧ** button **(10)** down for approx. 10 seconds until two short signal tones can be heard.

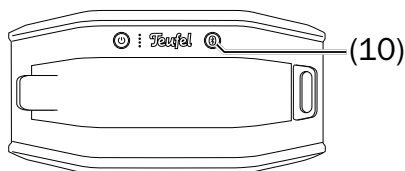

AUX

Connection

The AUX IN jack **(14)** serves to connect an external player using a stereo cable with a 3.5 mm jack plug. You can connect any external players with a line-out jack or earphone jack.

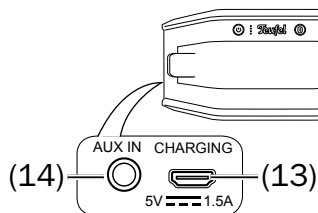

Playback

1. If applicable, stop playback from a Bluetooth® device.
2. Start playback on your external player.

i The volume setting of the external player affects the volume of the ROCKSTER GO.

3. Control all playback functions via the external player.

Connect mode

You can pair the ROCKSTER GO with compatible devices via Bluetooth® so both devices play the same music. When pairing, both devices must be placed directly next to each other.

However, then the distance between the paired devices can be up to 5 meters.

Thus, you can use two devices at the same time to supply a larger area with sound.

1. Push and hold the buttons **⌘ (10)** and **+ (6)** at the same time for approx. 3 seconds. Pairing has been initiated and the ring around the **⌘ (10)** will pulse in blue.

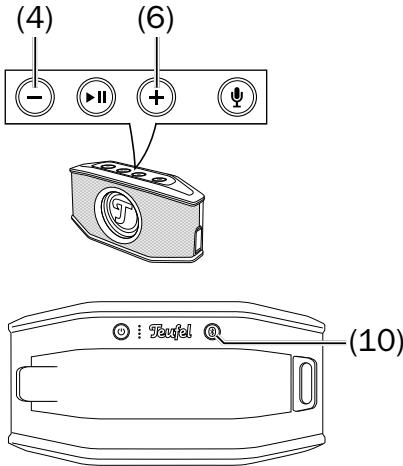

2. Also start pairing on the second device. If also the second device is a ROCKSTER GO push and hold the buttons **⌘ (10)** and **+ (6)** at the same time for approx. 3 seconds. (otherwise refer to the user manual for the other device).

The two devices will connect after a short time. On the ROCKSTER GO, the ring around the **⌘ (10)** will now illuminate continuously in blue.

- Turn on the Bluetooth® function on your external player, select the ROCKSTER GO and start playback. Both devices will now play the same music.
- To deactivate the connect mode, push and hold the buttons **⌘ (10)** and **- (4)** at the same time for approx. 3 seconds. The ring around the button **⌘ (10)** will go out indicating that the connection has been terminated.

PC sound card

The ROCKSTER GO features an integrated USB sound card for audio output.

No driver software is required for playback from the PC under Windows 7, 8 and 10. The operating systems detect the ROCKSTER GO as a “USB Advanced Audio Device” when it is connected to the USB port.

Connect the USB micro port **(13)** to a USB port on your PC. You can use the enclosed charging cable or any other type A USB 2.0 adapter cable to micro B for this.

Playback

This will activate playback via the sound card function.

You only adjust the volume of the amplifier on the ROCKSTER GO, all other settings are controlled from your PC.

Windows 7, 8 and 10:

When establishing the USB connection, Windows automatically detects the ROCKSTER GO and allocates playback accordingly.

To quickly switch between the playback devices, right click the speaker icon on the task bar and select “Playback devices”. The corresponding “Sound” tab of the control panel will open.

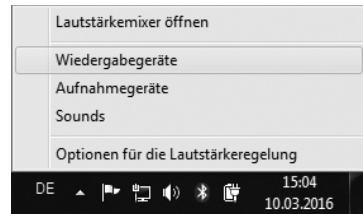

“Sound” control panel

In the “Sound” control panel, you can select the ROCKSTER GO as the playback device on the “Playback” tab: In the list, click “Speaker” under “Teufel ROCKSTER GO”. All PC sounds will now be played back via the ROCKSTER GO.



Further sound settings depend on the programme in use, e.g. Media Center or Skype.

Care And Cleaning

NOTICE

External influences may damage or destroy the device.

- *If the device is to be left unattended for a prolonged period of time (e.g. during a vacation) or if a thunderstorm is forecast, pull the mains plug out of the socket. Otherwise, sudden overvoltage could cause the device to become defective.*
 - *If possible, only use plain water without any additives. In case of stubborn marks, a mild soap solution may be used.*
 - *Do not use caustic cleaning products, white spirit, thinners, petrol or similar under any circumstances. Such cleaning agents may damage the delicate surface of the housing.*
- Ideally, you should remove dust or small amounts of dirt with a dry, smooth leather cloth.
 - Use a damp cloth to rub off stubborn dirt. Make sure that no liquid penetrates the housing.
 - Then immediately wipe the damp surfaces off with a soft cloth without applying pressure.

Troubleshooting

The following advice should help you to solve problems. If this does not work, our online manual will provide help:

<https://manual.teufelaudio.com>

Problem	Possible cause/solution
The ROCKSTER GO doesn't emit sound.	The rechargeable battery is empty. Charge the rechargeable battery.
No sound.	The volume has been set too low. Increase the volume.
	The volume of the external player has been set too low. Carefully increase the volume of the external player.
No sound with Bluetooth®.	No Bluetooth® connection. Establish a connection (see „Bluetooth®“ on page 16).
	ROCKSTER GO has not been selected as the output device. On the external player, select “Teufel ROCKSTER GO” as the Bluetooth® output device.
	Bluetooth® connection impaired by another radio system (e.g. cordless telephone, Wi-Fi). Move the devices causing the disturbance.
Playback is noisy.	Generally speaking, the ROCKSTER GO is a very low-noise system. In most cases, the speaker system with very high resolution in the high range area can expose the poor quality of a signal source (e.g. from MP3 files). Ensure that the source is sending a clear signal to the ROCKSTER GO.
The voice assistant doesn't work.	Activate the voice assistant on the smartphone.

Technical Data

Power supply	Rechargeable lithium ion battery, 3.7 V, 4.4 Ah
Charging voltage	USB: 5 V / 1.5 A
Dimensions (W×H×D)	209 × 108 × 63 mm
Weight	760 g
Waterproofness (IP protection type)	IPX7

The following radio frequency bands and radio transmitting powers are used in this product:

Frequency bands	Max. transmission power
2.4–2.4835 GHz	2.5 mW/4 dBm

You can find further technical data about the product on our website.

Declaration Of Conformity

 Lautsprecher Teufel GmbH declares that this product complies with Directive 2014/53/EU. The full text of the EU Declaration of Conformity can be found at this web address:

www.teufel.de/konformitaetserklaerungen
www.teufelaudio.com/declaration-of-conformity

Disposal

Important information in accordance with the Electrical and Electronic Equipment Act (Germany: ElektroG)

We advise owners of electrical and electronic appliances that old electrical and electronic devices must be handed in separately from municipal waste, in accordance with the applicable regulations. Batteries and rechargeable batteries that are not firmly enclosed in old electrical devices and lamps, and that can be removed from the old device without destroying them, must be separated from them in a non-destructive manner before they are handed to the collection point for their intended disposal. Please take note of our information on the Batteries Act [Germany: BattG] below for disposing of batteries.

You make an important contribution to returning, recycling and further processing of old devices if you separate your old devices into the correct collection groups for recycling.

The symbol below of a crossed-out dustbin, applied to electrical and electronic appliances, also advises of the duty to separate collections:



Consumer electronics stores and supermarkets are obliged, under certain conditions, to take back old electrical and electronic devices, in accordance with section 17 of the Electrical and Electronic Equipment Act. Stationary retailers must take back an old electrical device of the same type when a new electrical device is bought (1:1 return). This also applies to home deliveries. These retailers must also take back up to three small old electrical devices ($\leq 25\text{cm}$) without this being linked to a new purchase (0:1 return).

In accordance with the Electrical and Electronic Equipment Act, as online retailers of electrical devices and due to our product range, our obligation is limited to 1:1 return of large devices of $> 50\text{ cm}$ when selling a new electrical or electronic device of the same type. We comply with the obligation of return of devices other than large devices through our service provider. You can find the exact contact data and collection points on our website www.Teufel.de/entsorgung. It is also possible to return old electrical and electronic appliances free of charge at an official delivery point run by the public waste disposal authorities.

Important: For safety reasons we ask that you refrain from sending lighting fixtures (some lamps). For return of lighting fixtures please use the public waste disposal collection points or contact us directly at www.Teufel.de/entsorgung.

As an end-user, you are responsible for deleting any personal data on old electrical appliances before handing it in.

Important: Our appliances can contain batteries/rechargeable batteries. If this is the case, please refer to its attached product documentation for additional information on the type and chemical make-up of the battery. For products with battery compartments you can directly remove the batteries or rechargeable batteries and dispose of them properly. If the batteries are built in to the product, do not in any case attempt to remove the batteries yourself, instead contact one of our employees or appropriate specialist staff.

Important information about the Batteries Act (Germany: BattG)

Batteries and rechargeable batteries must not be disposed on in household waste.

Old batteries can contain toxic substances that could damage the environment or your health if not stored or disposed of properly. This applies especially to improper handling of batteries containing lithium.

However, batteries also contain important raw materials such as iron, zinc, manganese and nickel and these can be reused. Separate collection enables recycling of these raw materials and avoids any negative impact on the environment or human health due to toxic substances being released.



The crossed-out dustbin symbol means that you should not dispose of old batteries and rechargeable batteries in household waste. In addition, you, as the end-user, are legally obliged to return old batteries.

You can hand in batteries and rechargeable batteries free of charge at an official return point such as any public waste disposal collection point. You can also hand in old batteries, that we stock or have stocked as new batteries, at one of our Teufel stores or at one of our dispatch warehouses. However, if you send them to our dispatch warehouses we would like to point out the dangerous goods regulations of the dispatch provider you opt for and ask you not send batteries to us by post. You can get the addresses of our dispatch warehouses from our customer service.

Due to existing legal regulations, the battery manufacturer must use the following symbols with the following meanings when marking the batteries.

Hg: the battery contains more than
0.0005 mass percent of mercury

Pb: the battery contains more than
0.004 mass percent of lead

Cd: the battery contains more than
0.002 mass percent of cadmium

Otherwise, to avoid waste and littering, batteries with a long service life or rechargeable batteries should be used. Exchangeable rechargeable batteries enable long service for electrical and electronic appliances and thus devices and rechargeable batteries can be prepared for recycling (e.g. regenerating/exchanging rechargeable batteries).

Further information on preventing waste for consumers can, however, be found in the Federal waste prevention programme with the participation of the Federal states.

Teufel

Please contact our customer service department with any questions, suggestions, or complaints:

Lautsprecher Teufel GmbH
BIKINI Berlin, Budapester Straße 44
10787 Berlin (Germany)
www.teufelaudio.com

Phone: 00800 200 300 40 (toll-free)

Fax: +49 (0)30 - 300 930 930

Online-support:
www.teufelaudio.com/service

Contact:
www.teufelaudio.com/contact

No responsibility is assumed for the correctness of this information.
Technical changes, typographical errors and other errors reserved.