

Technical description and user manual

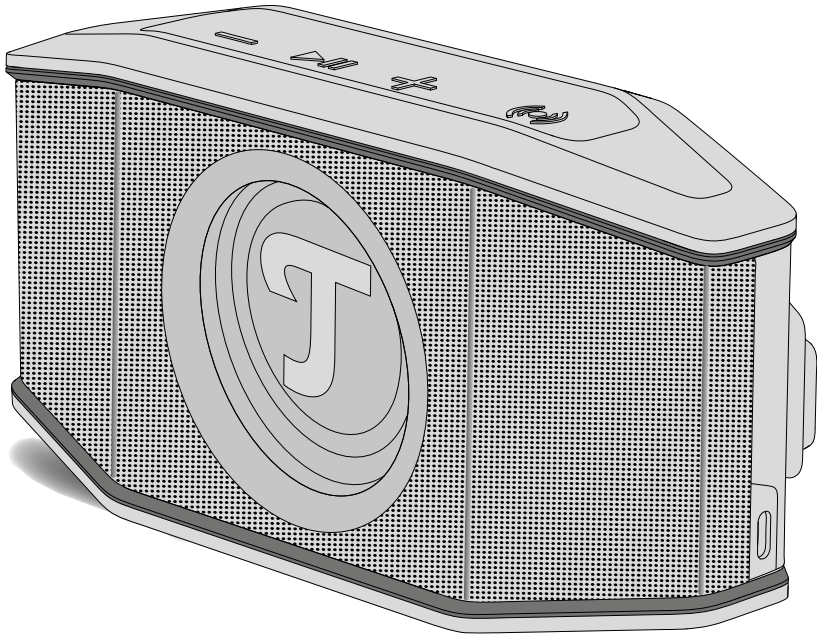

ROCKSTER®

ROCKSTER® GO 2

Water-Protected Active Bluetooth® Loudspeaker

Teufel

Table of contents

Basic notes and information.....	3	Operation.....	12
For your information	3	Switching on and off.....	12
Applicability of the user manual	3	Auto-off	12
Trademark	3	Setting the playback source	12
Data protection and		Setting Bluetooth®	
advertising declaration.....	4	as the playback source.....	12
Original packaging	4	Setting USB	
Complaints	4	as the playback source.....	12
Contact	4	Controlling playback	12
Safety.....	5	Starting playback.....	12
Intended use.....	5	Pausing and	
Explanation of warnings	5	restarting/muting playback.....	12
Scope of supply	6	Playing the previous track.....	13
Unpacking the loudspeakers.....	6	Playing the next track	13
Checking the scope of supply	6	Adjusting the volume	13
Operating and display elements	7	Switching Dynamore® on and off	13
Setup	9	Power supply (battery).....	14
Notes on the place of installation ...	9	Charging the battery	14
PA stand	9	Displaying the charge level.....	15
Carrying strap	9	Power saving mode (eco mode)	15
Connecting players	10	Other functions.....	16
Bluetooth®.....	10	Party Link	16
Pairing Bluetooth® devices	10	Activating	
Disconnecting the		the Party Link function	16
Bluetooth® connection.....	10	Deactivating	
Deleting the Bluetooth® list.....	10	the Party Link function	16
Changing Bluetooth® devices.....	11	Party Link Stereo.....	16
PC sound card function (USB).....	11	Activating	
		the Party Link Stereo function	17
		Deactivating	
		the Party Link Stereo function	17
		Cleaning and care.....	18
		Troubleshooting.....	19
		Resetting to factory settings	19
		Technical data	20

Basic notes and information

For your information

The information in this document is subject to change without notice and does not constitute any obligation on the part of Lautsprecher Teufel GmbH.

No part of these user manuals may be reproduced, transmitted in any form or by any means electronically, mechanically, by photocopying or by recording without the prior written permission of Lautsprecher Teufel GmbH.

© Lautsprecher Teufel GmbH
Teufel ROCKSTER® GO 2 UM EN V1.3 PD

Applicability of the user manual

The user manual applies exclusively to the **ROCKSTER® GO 2** loudspeaker, hereinafter also referred to as the “loudspeaker”.

Trademark

© All trademarks are the property of their respective owners and any use by Lautsprecher Teufel is under licence.



Bluetooth® is a registered trademark of the Bluetooth SIG, Inc.

Data protection and advertising declaration

Lautsprecher Teufel GmbH has no connection with the services of the Google Assistant system. We do not store any personal data and are not involved in any promotional mailings.

Original packaging

If you wish to make use of your right of return, we must ask you to keep the packaging.

We can only take back loudspeakers in their original packaging.

Empty cardboard boxes are not available.

Complaints

In the event of a complaint, we absolutely require the following information for processing:

1. Invoice number

- ▶ Please refer to the proof of purchase (enclosed with the loudspeaker), or the order confirmation that you received as a PDF document.

2. Serial number

- ▶ Refer to the rear of the loudspeaker.

Contact

If you have any questions, suggestions or criticisms, please contact us at:

Lautsprecher Teufel GmbH

BIKINI Berlin
Budapester Straße 44
10787 Berlin (Germany)

Tel.:

Germany: +49 (0) 30 217 84 217
Austria: +43 12 05 22 3
Switzerland: +41 43 50 84 08 3
International: 0800 200 300 40 (toll-free)

Online support:

teufelaudio.com/support
teufel.de/support

Kontakt:

teufelaudio.com/contact
teufel.de/kontakt

Safety

Intended use

The loudspeaker is designed to play music and speech via Bluetooth® or a cable from an external player. Only use the loudspeakers as described in this user manual.

Any other use is deemed to be improper and may result in material damage or even personal injury.

The manufacturer accepts no liability for damage caused by improper use.

The loudspeaker is intended for use in the private sphere.

Before starting up the loudspeaker:

- ▶ Read the user manual and safety booklet carefully.
- ▶ Keep the instructions in a safe place so that they can be passed on to third parties.
 - ▶ When passing on the loudspeaker, also pass on the instructions.

Explanation of warnings

Handling-related warnings precede handling steps that may result in a hazard.

The warnings are grouped into different risk categories depending on the seriousness of the respective hazard.

The hazard levels with the corresponding signal words are explained below.

WARNING

Possible danger to life or serious injury.

ATTENTION

Possible material damage.

NOTE

Additional information and tips.

Scope of supply

Unpacking the loudspeakers

- ▶ Open the box carefully, remove the packaging and carefully lift the loudspeaker out of the box.

Checking the scope of supply

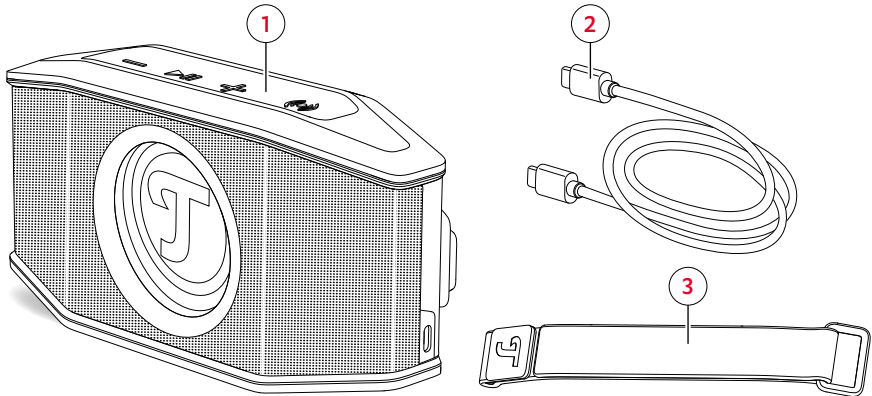

Scope of supply

- (1) ROCKSTER® GO 2
- (2) USB-C cable
- (3) Carrying strap

i NOTE



A charging adapter is not included in the delivery scope.

- ▶ Check the scope of supply for completeness.
- ▶ Check the scope of supply for damage.
- ▶ Keep the original packaging during the warranty period.

Operating and display elements

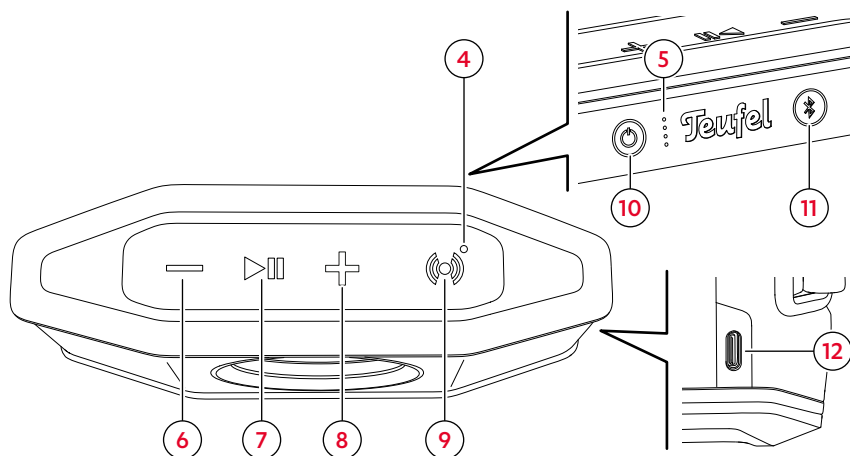

Operating and display elements on the loudspeaker

No.	Screen
(4)	Dynamore® On / Off
(5)	Battery and charging indicator

Legend (actuation):

● = Press 1×

● ● = Press 2×





1,5 s = Hold pressed down (1.5 s)















4 s = Hold pressed down (4 s)

8 s = Hold pressed down (8 s)

HOLD = Press and hold

No.	Button/ connection	Function	Actuation
(6)	—	Decrease the volume → <i>Adjusting the volume – p. 13</i>	● HOLD
(7)	▶	→ <i>Pausing and restarting/muting playback – p. 12</i>	● ●
(8)	+	Increase the volume → <i>Adjusting the volume – p. 13</i>	● HOLD
(9)	(🔊)	→ <i>Switching Dynamore® on and off – p. 13</i>	● ●
(10)	⏻	→ <i>Switching on and off – p. 12</i>	1,5 s
		→ <i>Displaying the charge level – p. 15</i>	● ●

No.	Button/ connection	Function	Actuation
(11)		→ Setting Bluetooth® as the playback source – p. 12	
		→ Changing Bluetooth® devices – p. 11	
		→ Pairing Bluetooth® devices – p. 10	
		→ Deleting the Bluetooth® list – p. 10	
(12)	USB	→ Charging the battery – p. 14	Plug-in
		→ Setting USB as the playback source – p. 12	Plug-in

No.	Button combination*	Function	Actuation
(6) (7)		→ Playing the previous track – p. 13	
(7) (8)		→ Playing the next track – p. 13	
(8) (11)		→ Activating the Party Link function – p. 16	
(6) (11)		→ Deactivating the Party Link function – p. 16	
		→ Deactivating the Party Link Stereo function – p. 17	
(7) (11)		→ Activating the Party Link Stereo function – p. 17	
(9) (10)		→ Resetting to factory settings – p. 19	
(6) (9)		→ Power saving mode – p. 15	

* With button combinations, both buttons must be pressed simultaneously.

Setup

1. Carry the loudspeaker carefully to the place of installation.
→ *Notes on the place of installation – p. 9*
 2. Place the loudspeaker on a stable, level surface.
 - ▶ Make sure that the loudspeaker is resting firmly in a stable position to prevent vibrations.
- The speaker is set up.**

Notes on the place of installation

- Dry, dust-free environment.
- Avoid proximity to heat sources and direct sunlight.
- Connected cables (e.g. charging cables) must not present a tripping hazard.

PA stand

A threaded hole (1/4" × 12 mm) on the bottom of the loudspeaker allows you to mount the loudspeaker on a photo or PA stand.

Carrying strap

The carrying strap (3) can be used to secure the loudspeaker in a variety of ways.

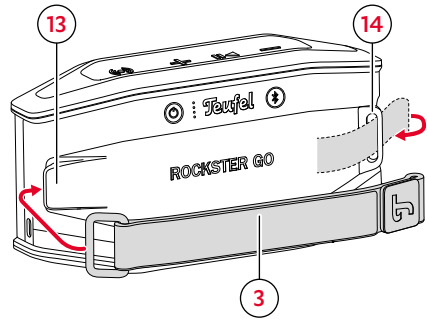

Attaching the carrying strap

1. Push the Velcro fastener on the end of the carrying strap through the loop (14).
 2. Fold over the end of the carrying strap so that the Velcro fasteners interlock.
 3. Clip the buckle on the carrying strap over the hook (13).
- The carrying strap is secured.**

Connecting players

Depending on the respective playback source, a cable connection or wireless connection to the loudspeaker must be established so that the loudspeaker can emit the audio signal from the playback source.

Bluetooth®

A compatible external player is connected wirelessly to the loudspeaker via Bluetooth®.

NOTE

Only use the Bluetooth® function in places where wireless radio transmission is permitted.

Pairing Bluetooth® devices

Coupling (pairing) connects the external player with the loudspeaker.

NOTE

Up to 7 external players can be stored and automatically connected without pairing again.

1. Activate the Bluetooth® function on the external player
2. Press and hold the  button (11) for 4 seconds.

The  button (11) flashes blue.

-  **Bluetooth® pairing mode is activated.**

3. Search for Bluetooth® devices on the external player.
 - ▶ Follow the user manual of the external player.
4. Select the “ROCKSTER GO 2” loudspeaker from the list of Bluetooth® devices.

The  button (11) lights up continuously blue.

-  **The pairing procedure is completed. The Bluetooth® device is connected to the loudspeaker.**

- ▶ Use the loudspeaker as the output device.

Disconnecting the Bluetooth® connection

- ▶ Deactivate the Bluetooth® function on the external player.
-  **The Bluetooth® connection has been disconnected.**

Deleting the Bluetooth® list

- ▶ Press and hold the  button (11) for 8 seconds.





The  button (11) flashes blue once.

-  **The Bluetooth® list has been deleted.**

Changing Bluetooth® devices

If two Bluetooth® devices are connected to the loudspeaker at the same time, you can easily switch between playback on either device.

→ *Pairing Bluetooth® devices – p. 10*

1. Stop playback on the first external player.
2. Press the  button **(11)**.
The  button **(11)** flashes blue once.
 The active Bluetooth® device has changed.
3. Start playback on the second external device.
 Media playback from the second external player is emitted through the loudspeaker.
4. Press the  button **(11)** again.
The  button **(11)** flashes blue once.
 The active Bluetooth® device has changed again.
5. Start playback on the first external device.
 Media playback from the first external player is emitted through the loudspeaker.

PC sound card function (USB)

The loudspeaker has an integral USB sound card for audio output. You can connect a compatible external player to the loudspeaker via the USB port **(12)** using the USB-C cable supplied **(2)**.

- ▶ Connect the external device to the loudspeaker using the USB-C cable supplied **(2)**.

The  button **(11)** lights up continuously white.

- The external USB player is connected to the loudspeaker.**

- ▶ Use the loudspeaker as the output device.

NOTE

Bluetooth® playback is not possible during playback via the USB port.

Operation

Switching on and off

- ▶ Press and hold the  button (10) for 1.5 seconds.

The loudspeaker turns on with a beep. The  button (10) lights up continuously white.

- ✔ **The loudspeaker is switched on.**

- ▶ Press and hold the  button (10) again for 1.5 seconds.

The loudspeaker turns off with a beep. The  button (10) goes out.

- ✔ **The speaker is switched off.**

Auto-off

After 10 minutes without an input signal, the loudspeaker will switch off automatically.

Setting the playback source

Setting Bluetooth® as the playback source

- ▶ Press the  button (11).

The  button (11) lights up continuously blue.

- ✔ **Bluetooth® has been set as the playback source.**

Setting USB as the playback source

An external USB player is automatically set as the playback source as soon as it is connected.

→ *PC sound card function (USB) – p. 11*

Controlling playback



Starting playback

- ▶ Start playback via the connected player (Bluetooth® device or USB device).

Pausing and restarting/muting playback

NOTE

It is not possible to pause playback from USB playback sources. Instead, playback is muted.

- ▶ Press the  button (7).
- ✔ **Playback is paused/muted (depending on the source).**
- ▶ Press the  button (7) again.
- ✔ **Playback continues/muting is cancelled (depending on the source).**

Playing the previous track

- ▶ Press the button combination **— (6) | ▶ || (7)**.
- ☑ The current track is started from the beginning. (If the track has been played for more than 3 seconds.)
- ☑ The previous track is started. (If the track has been played for less than 3 seconds.)
- ▶ Press the button combination **— (6) | ▶ || (7) 2×**.
- ☑ The previous track is started.

Playing the next track

- ▶ Press the button combination **▶ || (7) | + (8)**.
- ☑ The next track is started.

Adjusting the volume

i NOTE

The volume setting on the external player also affects the loudspeaker's volume.

- ▶ Press the **—** button (6).
 - ▶ To lower/increase the volume gradually (faster), press and hold the **—** button (6).
- ☑ The volume is lowered.

- ▶ Press the **+** button (8).
 - ▶ To lower/increase the volume gradually (faster), press and hold the **+** button (8).
- ☑ The volume is increased.

Switching Dynamore® on and off

Dynamore® is a technology developed by Teufel that virtually expands the stereo panorama to create an impressive, wide-ranging sound.

i NOTE

The use of Dynamore® shortens the operating time of the loudspeaker in battery mode.

- ▶ Press the **(o)** button (9).
 - The LED indicator (5) lights up.
- ☑ **Dynamore® has been switched on.**
- ▶ Press the **(o)** button (9) again.
 - The LED indicator (5) goes out.
- ☑ **Dynamore® has been switched off.**

Power supply (battery)

Charging the battery

⚠ WARNING

Risk of injury from exploding batteries!

Batteries (especially lithium batteries) can explode if handled improperly.

- ▶ Do not heat, short-circuit or burn batteries.
- ▶ Protect batteries from direct sunlight.

ATTENTION

Risk of damage due to improper charging!

Improper charging may damage the loudspeaker or battery.

- ▶ Always use the supplied USB-C cable (2).

i NOTE

When the battery is almost discharged, the speaker emits two short warning tones several times and the bottom LED indicator (5) flashes. If this happens, charge the loudspeaker immediately.

i NOTE

To protect the battery, the loudspeaker has a deep discharge protection feature that switches off the device when the threshold is reached.

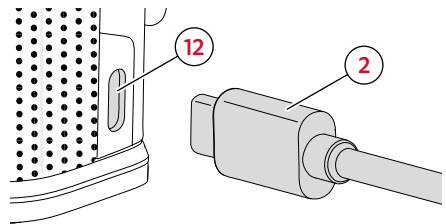

Charging cable connection

1. Insert the USB-C plug on the supplied USB-C cable (2) into the USB port (12) on the speaker.
 2. Connect the power supply as follows:
 - ▶ Connect the USB-C cable (2) to the power supply using a suitable power adapter.

or

 - ▶ Connect the USB-C cable (2) to a suitable power supply device.
- ✓ **The battery is charging.**

The LED indicator (5) indicates the current progress of the battery charge.

Key:

○ = LED off

⊛ = LED flashing

● = LED illuminated

Charging progress in %				
0-25 %	26-50 %	51-75 %	76-99 %	100 %
○	○	○	⊛	●
○	○	⊛	●	●
○	⊛	●	●	●
⊛	●	●	●	●
LEDs				

i NOTE

The fully charged battery allows an operating time of approx. 11 hours at medium volume.

Displaying the charge level

You can view the current battery charge level via the 4 LEDs on the LED display (5).

- ▶ Press the  button (10) while the loudspeaker is switched on.
- ☑ **The charge level is displayed.**

The number of illuminated LEDs indicates the current charge level.

Charge level in %				
0-10 %	11-25 %	26-50 %	51-75 %	76-100 %
○	○	○	○	●
○	○	○	●	●
○	○	●	●	●
⊛	●	●	●	●
LEDs				

Power saving mode (eco mode)

Power saving mode allows you to extend the battery life of the loudspeaker and increase its operating time up to 28 hours.

Activating power saving mode

- ▶ Press and hold the button combination — (6) | (⊞) (9) for 1.5 seconds.
- ☑ **Power saving mode is activated.**
A signal tone sounds and the **Dynamore® On / Off LED flashes briefly.**

Deactivating power saving mode

- ▶ Press and hold the button combination — (6) | (⊞) (9) again for 1.5 seconds.
- ☑ **Power saving mode is deactivated.**

Other functions

Party Link

The loudspeaker can be connected to a chain of up to 100 compatible loudspeakers via Bluetooth®, e.g. to provide sound for a larger room.

The first loudspeaker acts as the master when the Party Link function is used. You can control playback for the entire loudspeaker chain from the master loudspeaker or make specific adjustments on each connected loudspeaker (e.g. volume settings or Dynamore®).

Activating the Party Link function

1. Connect an external player to the first loudspeaker via Bluetooth® or the USB port. → *Connecting players – p. 10*
2. Press and hold the button combination **+** (8) | **⌘** (11) on the first loudspeaker for 4 seconds.

The **⌘** button (11) flashes blue.

- ✓ **Pairing mode is activated and the loudspeaker becomes the master loudspeaker in Party Link mode.**
3. Switch on another loudspeaker.
→ *Switching on and off – p. 12*
 4. Press and hold the button combination **+** (8) | **⌘** (11) on the unpaired loudspeaker for 4 seconds.

The **⌘** button (11) on the master loudspeaker lights up continuously blue.

The **⌘** button (11) on the second loudspeaker flashes blue once.

- ✓ **The loudspeaker is connected to the master. All paired speakers play back the same content.**
5. To connect additional loudspeakers, repeat steps 3 and 4 for each new loudspeaker (optional).

Deactivating the Party Link function

- ▶ Press and hold the button combination **–** (6) | **⌘** (11) for 4 seconds.
- ✓ **Pairing is cancelled and Party Link mode is deactivated on the loudspeaker.**

Party Link Stereo

Two loudspeakers of the same model can be operated using the Party Link Stereo function in Stereo L/R mode. When this function is activated, the speakers are paired via Bluetooth® and each loudspeaker is assigned a position L (left) or R (right).

- Loudspeaker L is positioned to the left of the listener.
- Loudspeaker R is positioned to the right of the listener.

Activating the Party Link Stereo function

1. Connect an external player to the first loudspeaker via Bluetooth® or the USB port. → *Connecting players – p. 10*
2. Press and hold the button combination **▶ || (7) | ✂ (11)** on the first loudspeaker for 4 seconds.

The ✂ button (11) flashes blue.

- ✓ **Pairing mode is activated.**

3. Switch on the second loudspeaker.
→ *Switching on and off – p. 12*
4. Press and hold the button combination **▶ || (7) | ✂ (11)** on the second loudspeaker for 4 seconds.

The ✂ button (11) on the first loudspeaker lights up continuously blue. The loudspeaker becomes channel L.

The ✂ button (11) on the second loudspeaker flashes blue once. The loudspeaker becomes channel R.

- ✓ **The loudspeakers are operating in stereo L / R mode and media playback is in stereo sound.**

i NOTE

Before switching between the Party Link and Party Link Stereo functions, first exit the active mode.

Deactivating the Party Link Stereo function

- ▶ Press and hold the button combination **— (6) | ✂ (11)** on the first loudspeaker (channel L) for 4 seconds.

- ✓ **The loudspeakers are unpaired and stereo playback stops.**

Cleaning and care

ATTENTION

Material damage due to improper cleaning!

The use of unsuitable cleaning agents can lead to the discolouration and destruction of the surface.

- ▶ Do not allow moisture to get inside.
- ▶ Only clean loudspeakers with a soft, dry cloth.

-
1. Remove dust and light contamination with a dry leather cloth.
 2. Remove stubborn stains with a cloth slightly moistened with mild soapy water.
 3. Then rub damp surfaces dry with a dry, soft cloth without applying pressure.
- ☑ **The loudspeaker has been cleaned**

Troubleshooting



- ▶ Follow the instructions below to eliminate possible faults:

Malfunction	Possible cause	Remedy
The loudspeaker does not start.	The battery is discharged.	▶ Connect the loudspeaker. → <i>Charging the battery – p. 14</i>
No sound.	The volume is too low.	▶ Increase the volume. → <i>Adjusting the volume – p. 13</i>
	The volume on the external player is too low.	▶ Increase the volume on the external player (e.g. smartphone).
	The loudspeaker is not connected to the external player.	▶ Connect the loudspeaker to the external player. → <i>Connecting players – p. 10</i>
	The external player has not been selected.	▶ Set the external player as the output device. → <i>Controlling playback – p. 12</i>
	Another radio system is interfering with the Bluetooth® connection.	▶ Move the loudspeaker to another location. → <i>Setup – p. 9</i>

Resetting to factory settings

i NOTE

All user settings and data are deleted and reset to the factory settings.

- ▶ Press and hold the button combination  (9) |  (10) for 8 seconds.
- ✔ **The loudspeaker has been reset to the factory settings. All personal settings have been deleted.**

Technical data

General technical data	
Dimensions (W × H × D)	210 mm × 108 mm × 62.5 mm
Weight	735 g
USB charging voltage	5 V, max. 3 A
Operating temperature	0°C to +45°C
Storage temperature	-20°C to +60°C
Protection class	IP67



Charging power adapter output required to charge the loudspeaker.
(minimum output to maximum output for maximum charging speed)

Radio network	Frequency bands	Transmitting power
Bluetooth®	2400–2483.5 MHz	4.9 mW / 6.9 dBm



Lautsprecher Teufel GmbH hereby declares that the ROCKSTER® GO 2 loudspeaker complies with Directive 2014/53/EU. The full text of the EU declaration of conformity is available at the following Internet address:

teufel.de/konformitaetserklaerungen

teufelaudio.com/declaration-of-conformity

Teufel

If you have any questions, suggestions or criticisms, please contact us at:

Lautsprecher Teufel GmbH

BIKINI Berlin
Budapester Straße 44
10787 Berlin (Germany)

teufelaudio.com

teufel.de

teufel.ch

teufelaudio.at

teufelaudio.nl

teufelaudio.be

teufelaudio.fr

teufelaudio.pl

teufelaudio.it

teufelaudio.es

Tel.:

Germany: +49 (0) 30 217 84 217

Austria: +43 12 05 22 3

Switzerland: +41 43 50 84 08 3

International: 0800 200 300 40 (toll-free)

Online support:

teufelaudio.com/support

teufel.de/support

Contact:

teufelaudio.com/contact

teufel.de/kontakt

All information is provided without guarantee. Subject to technical changes. Typographical and other errors excepted.