

Teufel

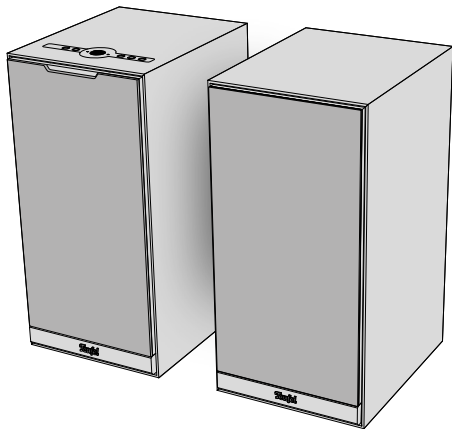

www.teufelaudio.com/stereo-m2



STEREO M 2

Active Speaker Set



Lieferumfang

Scope of delivery / Contenu de la livraison
Volumen de suministro / Ambito di consegna
Leveringsomvang / Zakres dostawy

Aktiv-Lautsprecher-Set
mit Netzanschluss

Active speaker set
with mains connection

Kit d'enceintes actives
avec raccordement au réseau

Conjunto de altavoces activos
con conexión a la red

Set di altoparlanti attivi
con collegamento alla rete

Actieve luidspreker set
met netaansluiting

Aktywny zestaw głośnikowy
z przyłączem sieciowym

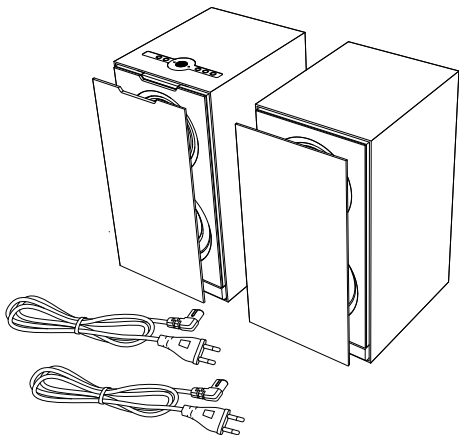



Lautsprecher-Setup

Room setup / Positionnement des haut-parleurs

Instalación de altavoces / Posizionamento degli altoparlanti

Luidsprekeropstelling / Ustawienie głośników

STEREO

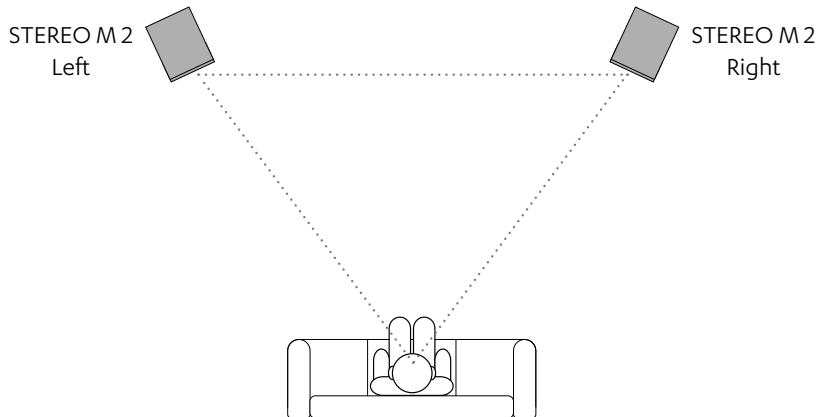



Netzanschluss

Power supply / Connexion au réseau

Conexión a la red / Collegamento di rete

Netaansluiting / Przyłącze sieciowe

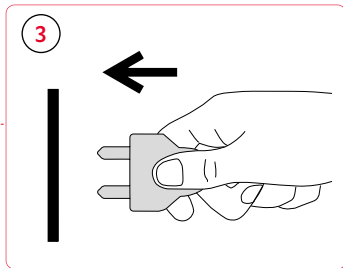
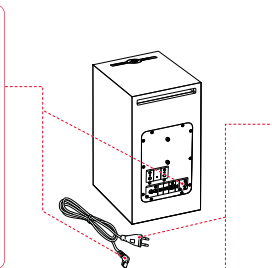
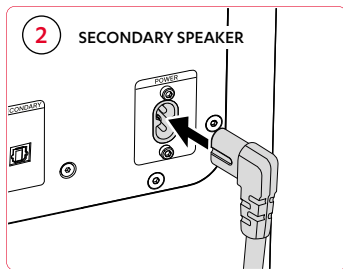
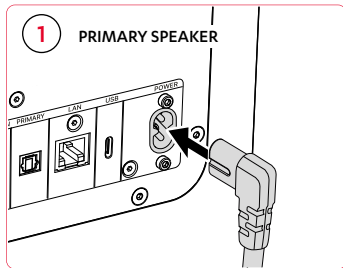



Lautsprecher verbinden

Connect speakers / Connecter des haut-parleurs

Conecta los altavoces / Collegare gli altoparlanti

Luidsprekers aansluiten / Podłączenie głośników

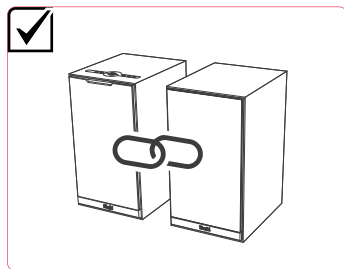
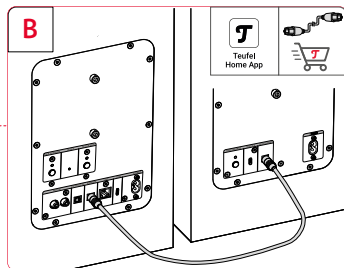
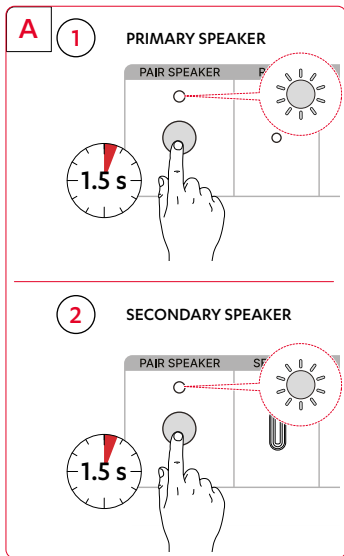



WiFi Verbindung
WiFi connection / Connexion WiFi
Conexión WiFi / Collegamento WiFi
WiFi verbindung / Połączenie WiFi

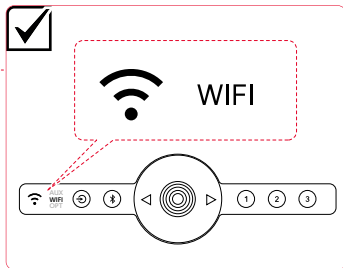
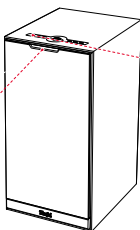
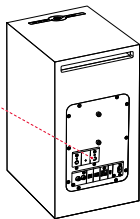
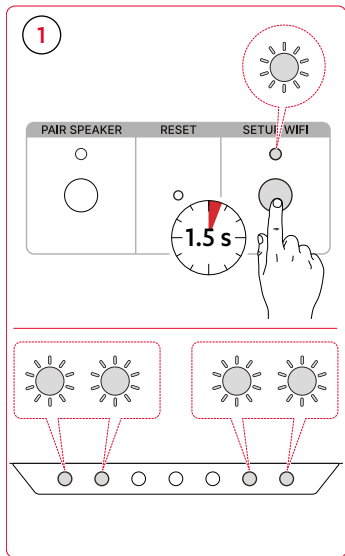



Bluetooth® Verbindung

Bluetooth® connection / Connexion Bluetooth®
Conexión Bluetooth® / Collegamento Bluetooth®
Bluetooth® verbinding / Połączenie Bluetooth®

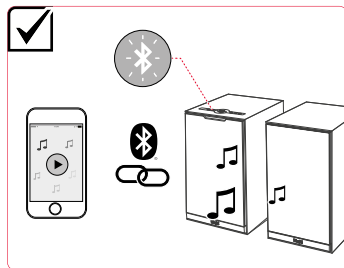
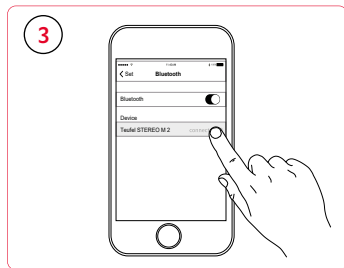
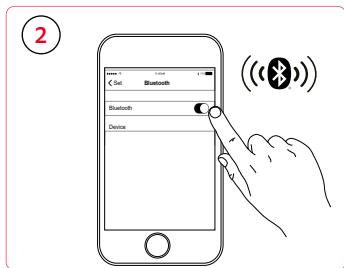
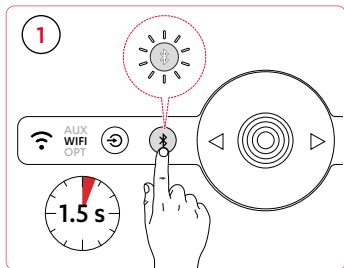



Lautstärke und Wiedergabe
Volume and playback / Volume et lecture
Volumen y reproducción / Volume e riproduzione
Volume en afspelen / Głośność i odtwarzanie

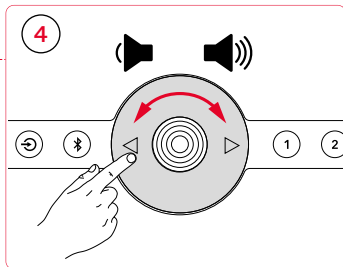
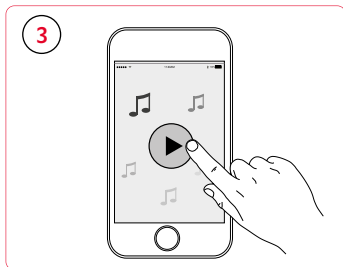
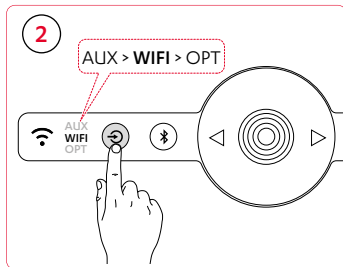
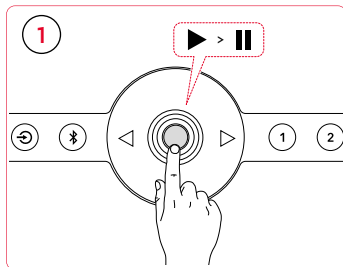



Anschlussarten

Connection types / Types de connexion

Tipos de conexión / Tipi di connessione

Typen verbindigen / Typy połączeń

A

AUX IN

1

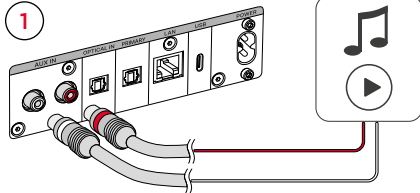

2

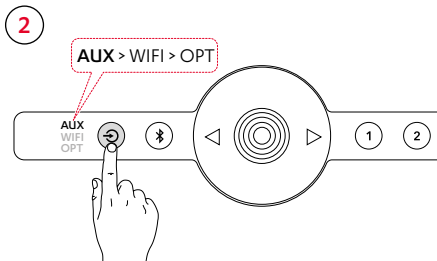

B

OPT

1

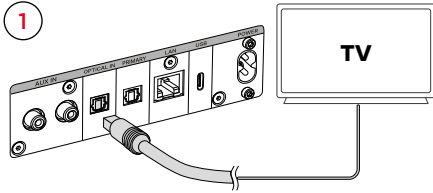

2

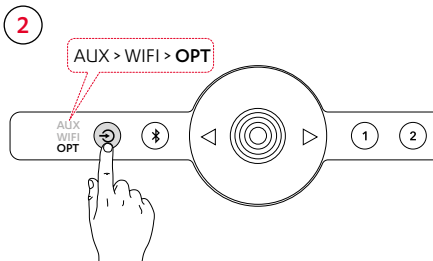



Technische Daten

Technical data / Données techniques

Datos técnicos / Dati tecnici

Technische gegevens / Dane techniczne

Abmessungen (B x H x T) /

Dimensions (W x H x D) / Dimensions (L x H x P) / Dimensiones (An x Al x P) / Dimensioni (L x A x P) / Afmetingen (b x h x d) / Wymiary (szer. x wys. x gł.)

210 mm x 422.5 mm x 264 mm

Gewicht Primär-Lautsprecher /

Weight primary speaker / Poids du haut-parleur primaire / Peso altavoz principal / Peso altoparlante primario / Gewicht primäre luidspreker / Masa głównego głośnika

10.1 kg

Gewicht Sekundär-Lautsprecher /

Weight secondary speaker / Poids du haut-parleur secondaire / Peso altavoz secundario / Peso altoparlante secundario / Gewicht sekundäre luidspreker / Masa głośnika dodatkowego

9.9 kg

Netzspannung /

Mains voltage / Tension secteur / Tensión de red / Tensione di rete / Netspanning / Napięcie sieciowe

220-240 V AC / 50 Hz

Maximale Leistungsaufnahme (je) /

Maximum power consumption (per) / Puissance maximale consommée (par) / Consumo máximo de potencia (por) / Consumo massimo di energia (per) / Maximaal energieverbruik (per) / Maksymalny pobór mocy (per)

240 W

Betriebs-Temperatur (von-bis) /

Operating temperature (from - to) / Température de fonctionnement (de - à) / Temperatura de funcionamiento (de - a) / Temperatura d'esercizio (da - a) / Bedrijfstemperatuur (van - tot) / Temperatura otoczenia podczas pracy (od - do)

0 °C – +45 °C

Lager-Temperatur /

Storage temperature (from - to) / Température de stockage (de - à) / Temperatura de almacenamiento (de - a) / Temperatura di conservazione (da - a) / Opslagtemperatuur (van - tot) / Temperatura przechowywania (od - do)

-20 °C – +60 °C

	Frequenzbänder / Frequency bands / Bande de fréquences / Potencia de transmisión / Bande di frequenza / Frequentiebanden / Pasma częstotliwości	Sendeleistung / Transmitting power / Puissance d'émission / Potencia de transmisión / Potenza di trasmissione / Zendvermogen / Moc nadawcza
Bluetooth®	2400 – 2483.5 MHz	9.4 dBm/8.7 mW
WLAN (WiFi) 2.4 GHz	2412 – 2472 MHz	17.86 dBm/61 mW
WLAN (WiFi) 5 GHz	5150 – 5350 MHz	18.14 dBm/65 mW
	5470 – 5725 MHz	18.14 dBm/65 mW
	5725 – 5850 MHz	18.14 dBm/65 mW
Funkverbindung Sekundär Lautsprecher / Radio connection secondary speaker / Liaison radio secondaire haut-parleurs / Conexión de radio altavoz secundario / Connessione radio altoparlante secondario / Radioverbinding secundaire luidspreker / Połączenie radiowe z dodatkowym głośnikiem	5725 – 5850 MHz	6.7 dBm/4.8 mW

Trademarks

© All trademarks are the property of their respective owners and any use by Lautsprecher Teufel is under licence.

Bluetooth® is a registered trademark of the Bluetooth SIG, Inc.

Android, Google, Google Play, Google Assistant, Google Home, Chromecast built-in and corresponding logos are registered trademarks of Google LLC.

Apple and AirPlay are trademarks of Apple Inc., registered in the U.S. and other countries.

Spotify® is subject to third-party licences.

Click on the following links to view the licences:

<https://developer.spotify.com/legal/third-party-licenses/#embedded-sdk-third-party-license>



Hereby, Lautsprecher Teufel GmbH declares that the radio equipment type STEREO M 2 is in compliance with Directive 2014/53/EU. The full text of the EU declaration of conformity is available at the following internet address:

www.teufel.de/konformitaetserklaerungen

www.teufelaudio.com/declaration-of-conformity

Teufel

Lautsprecher Teufel GmbH

Bikini Berlin, Budapester Str. 44

10787 Berlin (Germany)

www.teufelaudio.com

www.teufel.de

www.teufel.ch

www.teufelaudio.at

www.teufelaudio.nl

www.teufelaudio.be

www.teufelaudio.fr

www.teufelaudio.pl

www.teufelaudio.it

www.teufelaudio.es

Telefon

Deutschland +49 (0)30 217 84 217

Österreich +43 12 05 22 3

Schweiz +41 43 50 84 08 3

International 0800 200 300 40 (toll- free)

Telefax

+49 (0)30 / 300 930 930

Online-Support

www.teufelaudio.com/service

www.teufel.de/service

Kontaktformular

www.teufel.de/kontakt

Contact

www.teufelaudio.com/contact