

Teufel

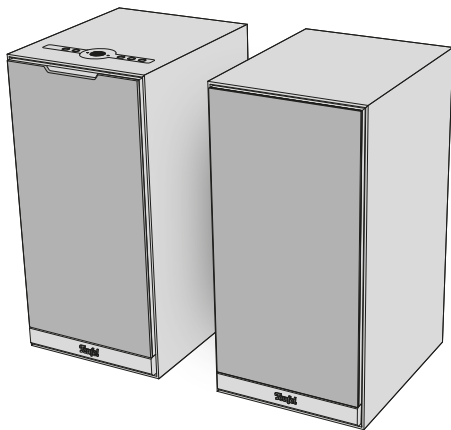

manuals.teufelaudio.com



STEREO M 2

Active speaker set



Lieferumfang

Scope of delivery / Contenu de la livraison
Volumen de suministro / Ambito di consegna
Leveringsomvang / Zakres dostawy

Aktiv-Lautsprecher-Set
mit Netzanschluss

Active speaker set
with mains connection

Kit d'enceintes actives
avec raccordement au réseau

Conjunto de altavoces activos
con conexión a la red

Set di altoparlanti attivi
con collegamento alla rete

Actieve luidspreker set
met netaansluiting

Aktywny zestaw głośnikowy
z przyłączem sieciowym

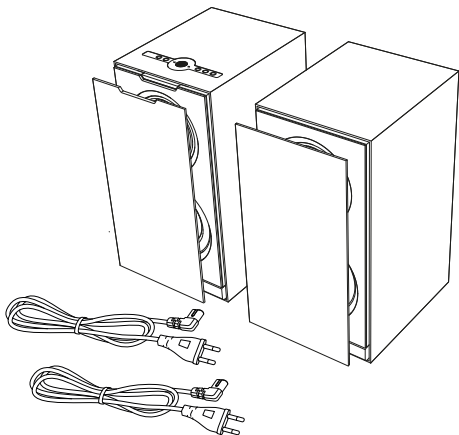



Lautsprecher-Setup
Room setup / Positionnement des haut-parleurs
Instalación de altavoces / Posizionamento degli altoparlanti
Luidsprekeropstelling / Ustawienie głośników

STEREO

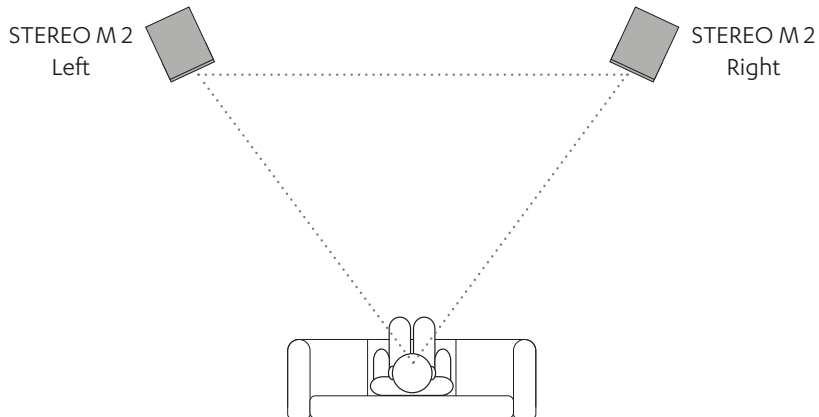



Netzanschluss

Power supply / Connexion au réseau

Conexión a la red / Collegamento di rete

Netaansluiting / Przyłącze sieciowe

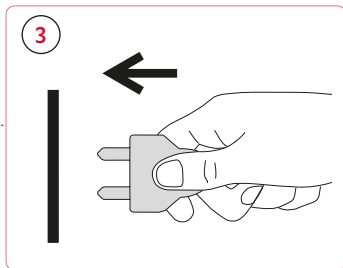
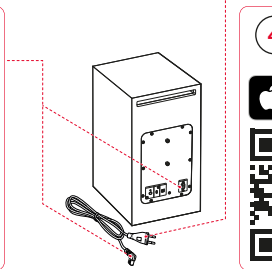
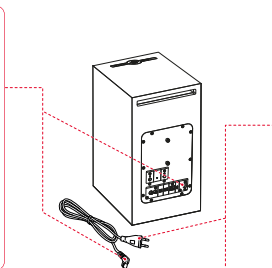
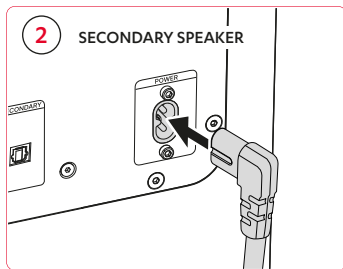
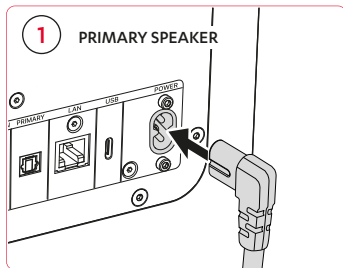



Lautsprecher verbinden

Connect speakers / Connecter des haut-parleurs

Conecta los altavoces / Collegare gli altoparlanti

Luidsprekers aansluiten / Podłączenie głośników

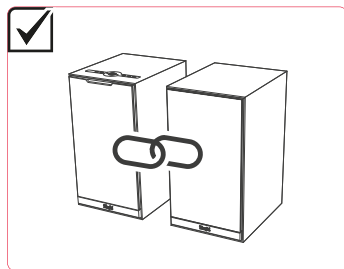
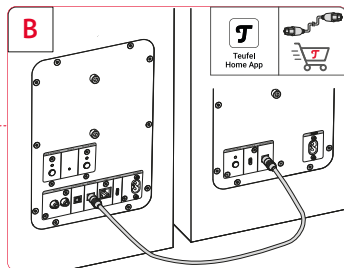
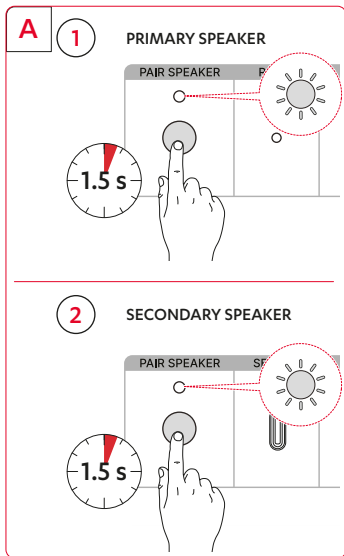



WiFi Verbindung
WiFi connection / Connexion WiFi
Conexión WiFi / Collegamento WiFi
WiFi verbindung / Połączenie WiFi

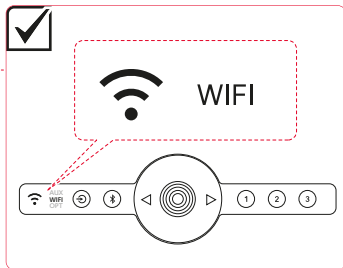
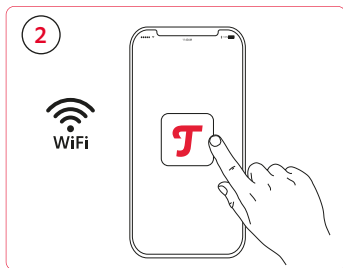
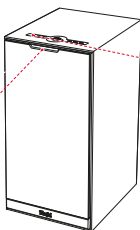
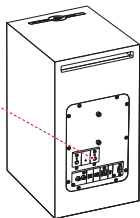
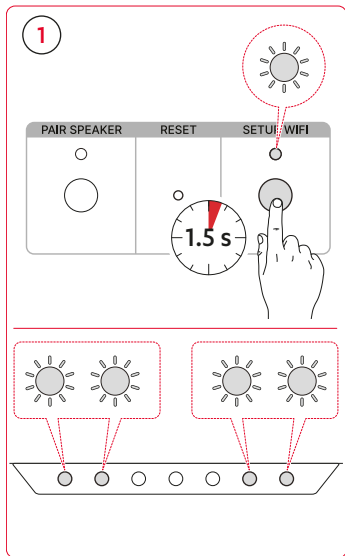



Bluetooth® Verbindung
Bluetooth® connection / Connexion Bluetooth®
Conexión Bluetooth® / Collegamento Bluetooth®
Bluetooth® verbinding / Połączenie Bluetooth®

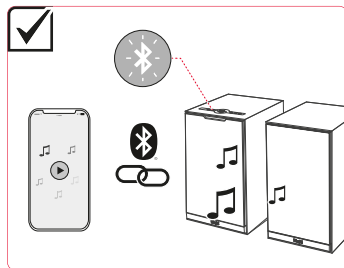
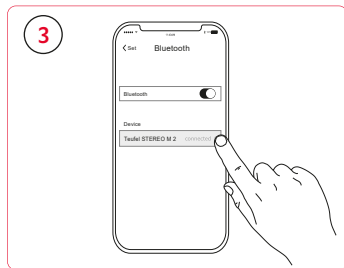
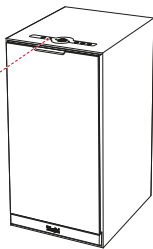
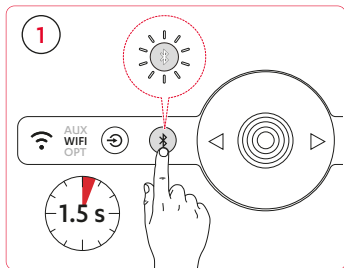



Lautstärke und Wiedergabe
Volume and playback / Volume et lecture
Volumen y reproducción / Volume e riproduzione
Volume en afspelen / Głośność i odtwarzanie

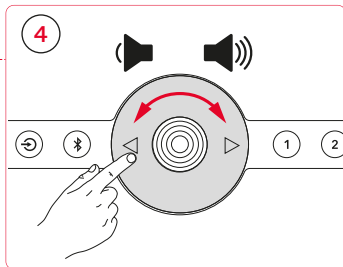
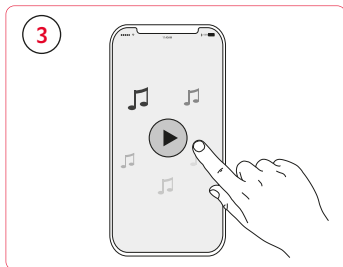
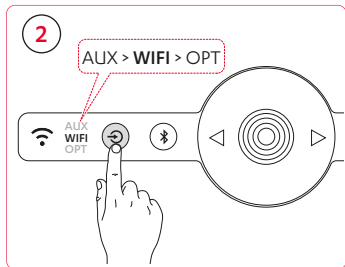
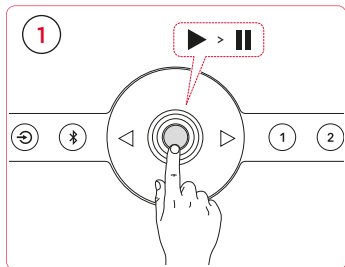

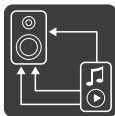

Anschlussarten

Connection types / Types de connexion

Tipos de conexión / Tipi di connessione

Typen verbindingen / Typy połączeń

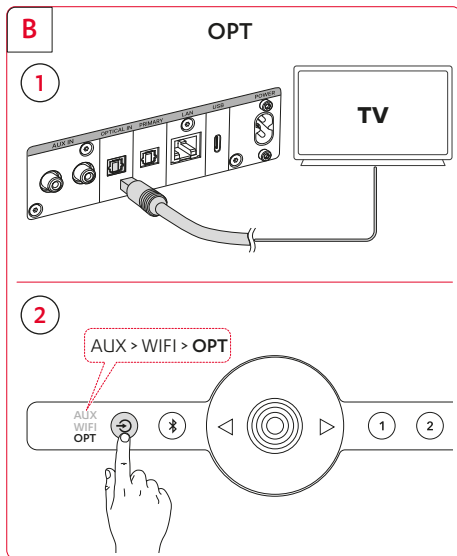
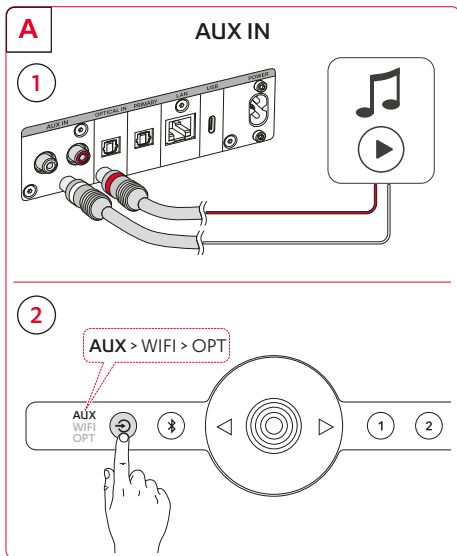



Technische Daten

Technical data / Données techniques

Datos técnicos / Dati tecnici

Technische gegevens / Dane techniczne

Abmessungen (B x H x T) /

Dimensions (W x H x D) / Dimensions (L x H x P) / Dimensiones (An x Al x P) / Dimensioni (L x A x P) / Afmetingen (b x h x d) / Wymiary (szer. x wys. x gł.)

210 mm x 422.5 mm x 264 mm

Gewicht Primär-Lautsprecher /

Weight primary speaker / Poids du haut-parleur primaire / Peso altavoz principal / Peso altoparlante primario / Gewicht primäre luidspreker / Masa głównego głośnika

10.1 kg

Gewicht Sekundär-Lautsprecher /

Weight secondary speaker / Poids du haut-parleur secondaire / Peso altavoz secundario / Peso altoparlante secundario / Gewicht sekundäre luidspreker / Masa głośnika dodatkowego

9.9 kg

Netzspannung /

Mains voltage / Tension secteur / Tensión de red / Tensione di rete / Netspanning / Napięcie sieciowe

220-240 V AC / 50 Hz

Maximale Leistungsaufnahme (je) /

Maximum power consumption (per) / Puissance maximale consommée (par) / Consumo máximo de potencia (por) / Consumo massimo di energia (per) / Maximaal energieverbruik (per) / Maksymalny pobór mocy (per)

240 W

Betriebs-Temperatur (von-bis) /

Operating temperature (from - to) / Température de fonctionnement (de - à) / Temperatura de funcionamiento (de - a) / Temperatura d'esercizio (da - a) / Bedrijfstemperatuur (van - tot) / Temperatura otoczenia podczas pracy (od - do)

0 °C – +45 °C

Lager-Temperatur /

Storage temperature (from - to) / Température de stockage (de - à) / Temperatura de almacenamiento (de - a) / Temperatura di conservazione (da - a) / Opslagtemperatuur (van - tot) / Temperatura przechowywania (od - do)

-20 °C – +60 °C

Funknetz / Radio network / Réseau radio / Rete radio / Red di radio / Draadloos netwerk / Sieć radiowa	Frequenzbänder / Frequency bands / Bande de fréquences / Potencia de transmisión / Bande di frequenza / Frequentiebanden / Pasma częstotliwości	Sendeleistung / Transmitting power / Puissance d'émission / Potencia de transmisión / Potenza di trasmissione / Zendvermogen / Moc nadawcza
Bluetooth®	2400 – 2483.5 MHz	9.4 dBm/8.7 mW
WLAN (WiFi) 2.4 GHz	2412 – 2472 MHz	17.86 dBm/61 mW
WLAN (WiFi) 5 GHz	5150 – 5350 MHz 5470 – 5725 MHz 5725 – 5850 MHz	18.14 dBm/65 mW 18.14 dBm/65 mW 18.14 dBm/65 mW



Der Frequenzbereich von 5150 bis 5350 MHz ist nur für die Nutzung in Innenräumen zugelassen. /

The 5150 to 5350 MHz frequency range is restricted to indoor use. / La plage de fréquences de 5150 à 5350 MHz est limitée à une utilisation en intérieur. / La gama de frecuencias de 5150 a 5350 MHz está restringida al uso en interiores. / La gamma di frequenze da 5150 a 5350 MHz è limitata all'uso in ambienti interni. / Het frequentiebereik van 5150 tot 5350 MHz is beperkt tot gebruik binnenshuis. / Zakres częstotliwości od 5150 do 5350 MHz jest ograniczony do użycia wewnątrz budynków.

Funkverbindung Sekundär-Lautsprecher / Radio connection secondary speaker / Liaison radio secondaire haut-parleurs / Conexión de radio altavoz secundario / Connessione radio altoparlante secondario / Radioverbinding secundaire luidspreker / Połączenie radiowe z dodatkowym głośnikiem	5725 – 5850 MHz	6.7 dBm/4.8 mW
--	-----------------	----------------

Trademarks

© All trademarks are the property of their respective owners and any use by Lautsprecher Teufel is under licence.

Bluetooth® is a registered trademark of the Bluetooth SIG, Inc.

Google Cast™ is a trademark of Google LLC.

Apple and AirPlay are trademarks of Apple Inc., registered in the U.S. and other countries and regions.

Spotify® is subject to third-party licences.

Click on the following links to view the licences:

<https://developer.spotify.com/legal/third-party-licenses/#embedded-sdk-third-party-license>

TIDAL, TIDAL Connect and corresponding logos are registered trademarks of Aspiro AB.

Teufel

Lautsprecher Teufel GmbH

Budapester Str. 44

10787 Berlin

Germany

teufelaudio.com

teufel.de

teufel.ch

teufelaudio.at

teufelaudio.nl

teufelaudio.be

teufelaudio.fr

teufelaudio.pl

teufelaudio.it

teufelaudio.es

Telefon/Phone

Deutschland	+49 (0)30 217 84 217
Österreich	+43 12 05 22 3
Schweiz	+41 43 50 84 08 3
International	0800 200 300 40 (toll- free)

Online-Support

teufelaudio.com/support
teufel.de/support

Kontaktformular/Contact

teufel.de/kontakt
teufelaudio.com/contact



Hereby, Lautsprecher Teufel GmbH declares that the radio equipment type STEREO M 2 is in compliance with Directive 2014/53/EU. The full text of the EU declaration of conformity is available at the following internet address:

teufel.de/konformitaetserklaerungen

teufelaudio.com/declaration-of-conformity