

Technical Description And User Manual

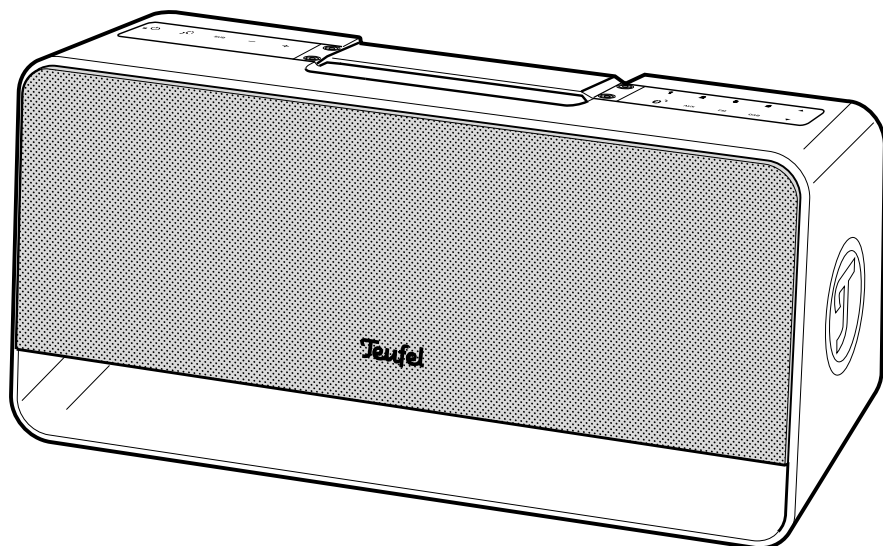

Boomster

Mobile active Bluetooth® speaker with integrated DAB+ and FM radio

Teufel

Contents

General Notes And Information	2	Operation	12
For Your Safety.....	4	Remote Control	18
Unpacking.....	7	Care And Cleaning.....	20
Operational Controls And		Troubleshooting.....	21
Connections.....	8	Technical Data	22
Preparation.....	10	Declaration Of Conformity.....	23

General Notes And Information

Notice

The information in this document may change without prior notice and in no way constitutes any liability on the part of Lautsprecher Teufel GmbH.

No part of this user manual may be reproduced in any form or be broadcasted in any way electronically, mechanically, by photocopy or recording without the written permission of Lautsprecher Teufel GmbH.

© Lautsprecher Teufel GmbH

Version 1.1

March 2020

Trademarks

© All trademarks are the property of their respective owners.



Bluetooth® and the Bluetooth symbol are trademarks of Bluetooth SIG, Inc.



aptX® and the aptX symbol are trademarks of CSR plc or associated companies and may be protected in multiple countries.

 The “N-Mark” symbol is a trademark or registered trademark of NFC Forum, Inc. in the USA and other countries.

Original packaging

If you wish to exercise your eight-week right of return, we ask that you be absolutely sure to hold onto the packaging. We can only accept the return of the speakers WITH THE ORIGINAL PACKAGING.

Empty boxes are not available!

Complaints

In case of a complaint we will need the following information to process your enquiry:

1. Invoice number

Can be found on the sales slip (enclosed with the product) or on the order confirmation received as a PDF document, e.g. 4322543

2. Serial number or batch number

Located on the bottom of the device, e.g. serial no.: KB20240129A-123.

Thank you for your support!

Contact

Please contact our customer service department with any questions, suggestions, or complaints:

Lautsprecher Teufel GmbH

BIKINI Berlin

Budapester Straße 44

10787 Berlin (Germany)

Phone:

Denmark	+4589886335
Finland	+358753263952
Norway	+4781503272
The Netherlands	+31208083195
Sweden	+46108885284
United Kingdom	+443308080489
The rest of Europe	+800 200 300 40

Online support:

www.teufelaudio.com/service

Contact form:

www.teufelaudio.com/contact

Proper use

The speaker is designed for the playback of music and speech from the integrated radio or an external player.

Only use the speaker as described in this user manual. Any other use will be deemed as not in accordance with the instructions and may lead to damage of property or even persons.

The manufacturer accepts no liability for damage caused by improper use.

The speaker is intended for private use.



Before operating the speaker, please read the safety notes and user manual carefully.

Only in this way, can you ensure that all functions are used in a safe and reliable manner. Store the user manual in a safe place and also be sure to pass it on to any subsequent owner.

For Your Safety

Signal terms

You can find the following signal terms in this user manual:

WARNING

This signal term indicates a moderate risk, which, if not avoided, may result in death or severe injury.

CAUTION

This signal term indicates a low risk, which, if not avoided, may result in minor or moderate injury.

NOTICE

This signal term warns you of potential damage.

Safety notes

This chapter contains general safety notes which you should always observe to protect yourself and third parties. Also observe the warning notes in each chapter of this user manual.

Touching live parts can result in severe injury or death.

- *When connecting the device, make sure that the correct voltage is present. You can find more information about this on the rating plate.*
- *Check the device regularly for damage. Immediately disconnect the mains plug and do not operate the device if its housing or mains cord is defective or exhibits other visible damages.*
- *The rechargeable battery switch (18) on the back of the device does not disconnect the device from the mains supply. This device can only be completely disconnected from the grid by pulling the mains plug. Thus, make sure that the mains plug is always easily accessible.*
- *If the device emits smoke, smells burnt or produces unusual sounds, immediately disconnect it from the mains and do not operate it further.*
- *Never open the device housing. Repairs may only be carried out by an authorised specialist workshop. Only parts that match the original specifications may be used.*
- *Only use the accessory products specified by the manufacturer.*
- *Do not operate the device in wet rooms and protect it from dripping and splashing water. Make sure that no vases or other liquid-filled*

objects are located on or near the device in order to prevent liquid from penetrating the housing. If water or other debris ends up penetrating the housing, immediately pull the mains plug and, if applicable, take out any batteries. Then send the device to our service address.

- Never modify the device. Unauthorised modifications may affect the safety and functionality.
- Never touch the mains plug with wet hands.

An unsuitable setup location may result in injury and damage.

- If the speaker is not securely mounted, do not use it in vehicles, in unstable locations, on wobbly tripods or furniture, on underdimensioned brackets etc. The speaker may tip or fall over and cause injury to persons or be damaged itself.
- Place the speaker in such a way that it cannot be knocked over inadvertently and make sure that the cables do not pose a tripping hazard.
- Do not place the speakers near heat sources (e.g. heaters, ovens, other heat generating equipment such as amplifiers etc.).
- Do not use the device in environments where there is a risk of explosion.
- Only use the Bluetooth function in locations where wireless radio transmission is allowed.

Children can become trapped in the plastic wrapping when playing and suffocate.

- Do not allow children to play with the device or the plastic wrapping. There is a danger of suffocation.
- Ensure that children do not remove small parts from the device or take them off of the device (e.g. control knobs or plug adapters). They could swallow the parts and choke.
- Never allow children to operate electrical equipment unsupervised.

Leaking battery acid may lead to chemical burns.

- Do not allow battery acid to come into contact with skin, eyes or mucous membranes. In the event of contact with battery acid, immediately flush the applicable areas with plenty of clean water and consult a physician if necessary.

Batteries (particularly lithium batteries) can explode if used improperly.

- Never attempt to recharge batteries.
- Only use batteries of the same or equivalent type.
- You must not heat or short circuit batteries and rechargeable batteries or dispose of them in fire.
- Do not expose batteries and rechargeable batteries to direct sunlight.

Extended listening at high volumes may lead to hearing loss.

To avoid damage to health, avoid extended listening at high volumes.

- *When the volume is set high, always keep a certain distance from the device and never place your ear directly on the speaker.*
- *If a speaker is set to full volume, this may produce very high sound pressure. This may have psychological consequences and also cause physical injury. Children and pets are particularly at risk. Set your signal source device volume control to a low setting before turning on the power.*

This product contains magnetic material.

- *If necessary, consult your physician and ask for effects on implants such as pacemakers or defibrillators.*

The isolation pads can produce discolouration on sensitive surfaces.

- *On parquet, varnished wood and similar surfaces, you should stick felt gliders to the rubber feet of the speaker or put blankets or small carpets under it. This will prevent discolouration of the floor over the long term.*

Unpacking

Package contents

- (1) Boomster NG
- (2) Telescopic antenna (already mounted)
- (3) Mains adapter
- (4) Mains cord for (2)
 - Quick reference guide
 - Brochure “Important product information”

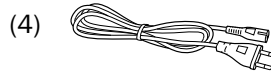
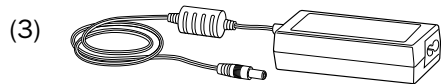
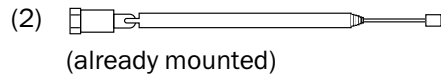
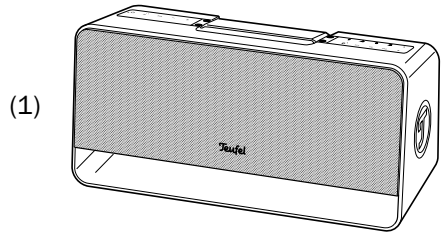

Optional accessories

- (5) Remote control “Teufel Puck”
- Check that all items have been delivered and that nothing is damaged. If you find any damage, do not operate the device; instead contact our customer service department (see back side).
 - Please keep the packaging for the duration of the warranty period.

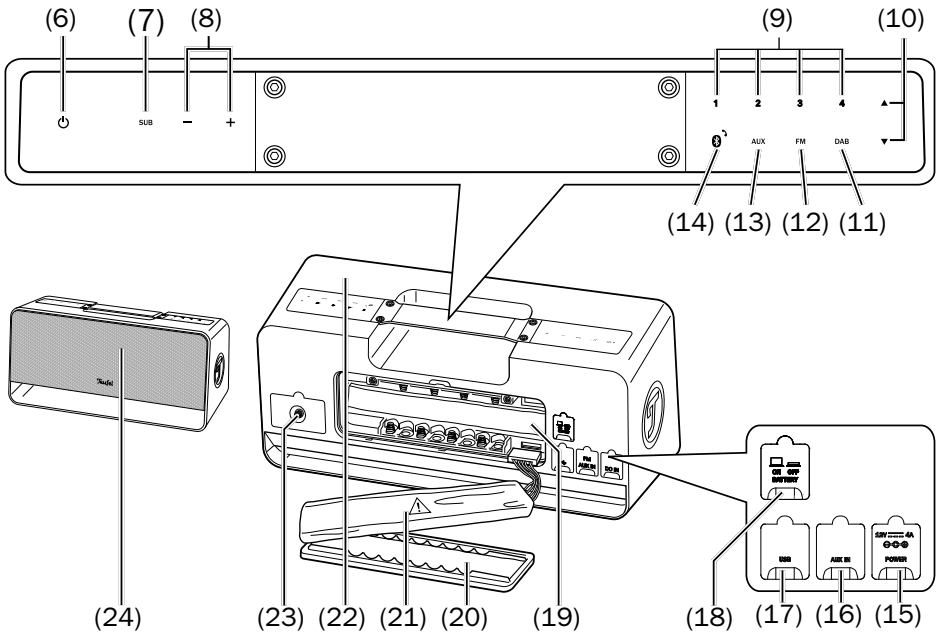

Operational Controls And Connections



(6) Push and hold  for 2.5 seconds: Switch the device on, the button will be illuminated in white.
 Tap  during operation: Show battery charge level in %.
 Push and hold  for 2.5 seconds: Switch the device off (in rechargeable battery/battery mode) or switch to standby (in 12 V mode).

(7) SUB: tap: Adjust the intensity of the subwoofer with the buttons (8) -/+. Display range -6 dB to +6 dB.
(8) -/+: Decrease (-)/increase (+) the volume, subwoofer. Volume range 0 (MUTE) to 16.
(9) 1, 2, 3, 4: Station buttons for DAB and FM radio stations.

(10) ▼/▲: Set the radio stations. For FM: Tap to set the frequency; pushing longer starts the station scan.

For DAB+: Switch to the previous/next station.

(11) DAB: Select digital radio (DAB+).

(12) FM: Select FM (USW) radio.

(13) AUX: Select the AUX () input.

(14) Tap Ⓜ: Select Bluetooth® as the source.

Press and hold Ⓜ: Start Bluetooth pairing mode.

Tap Ⓜ for a phone call: Accept incoming call.

(15) 12 volt connection for an external mains adapter or car charging cable (not included in the package contents).

(16) AUX input jack.

(17) USB jack to provide the power supply for external players.

(18) Rechargeable battery switch, disconnects the rechargeable battery pack or the batteries from the device.

(19) Rechargeable battery/battery compartment.

(20) Cover for (19).

(21) Rechargeable battery pack.

(22) NFC contact zone.

(23) Antenna connection.

(24) Display panel.

Preparation

Antenna

If not yet done, screw the enclosed telescopic antenna (2) onto the antenna connection (23).

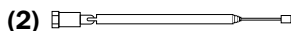
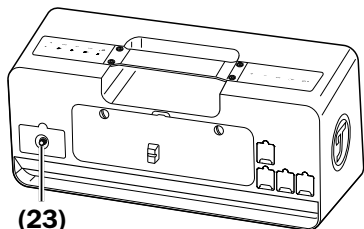

To receive radio stations, always pull the antenna all the way out.

For transport, you can lock the antenna, which has been pushed in, in the holder on the battery compartment cover.

Power supply

The Boomster offers three power supply options:

- 12 volt direct current via the mains adapter or car charger cable.
- Rechargeable battery
- Batteries (AA cells)

12 volt connection

For stationary operation:

1. Carefully open the rubber cap above the POWER jack (15) and turn the cap to the side or up.

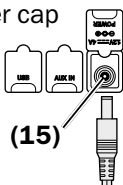

2. Insert the small plug of the enclosed mains adapter (3) in the POWER jack (15), which is now visible.



3. Use the enclosed mains cord (4) to connect the mains adapter to a mains socket.

Battery pack

The enclosed Li-Ion rechargeable battery pack will be charged as soon as the Boomster is supplied with power via the 12 volt connection (15) and the rechargeable battery switch (18) has been switched on (switch is out).

Before first use, charge the rechargeable battery for approx. 3 hours. In standby, the charging of the rechargeable battery is indicated by five plus symbols (+) on the display panel. That or the last plus symbols flash and indicate the charge level of the rechargeable battery. The flashing will stop once the rechargeable battery has been fully charged. The typical playback time with full charged internal battery is approx. 15 hours.

To protect the rechargeable battery, the Boomster has deep discharge protection, which switches the device off once the threshold is reached.

i If the charge of the rechargeable battery diminishes or the batteries are depleted, the message “BATT LOW” will appear on the display panel. In this case, replace the batteries or connect the mains cord.

Batteries

⚠ CAUTION

Batteries (particularly lithium batteries) can explode if used improperly.

- Never attempt to recharge batteries.
- Only use batteries of the same or equivalent type.
- You must not heat or short circuit batteries and rechargeable batteries or dispose of them in fire.
- Do not expose batteries and rechargeable batteries to direct sunlight.

Leaking battery acid may lead to chemical burns.

- Do not allow battery acid to come into contact with skin, eyes or mucous membranes. In the event of contact with acid, immediately flush the applicable areas with plenty of clean water and consult a physician if necessary.

Instead of using the enclosed rechargeable battery, the Boomster can also be operated using eight batteries of type AA (Mignon cell). For this, proceed as follows:

4. Open the battery compartment by turning the two screws on the cover counterclockwise (e.g. using a coin).
5. Remove the rechargeable battery and carefully pull the plug of the rechargeable battery out of the jack.
6. Insert eight AA batteries in the battery compartment. When inserting the batteries in the compartment, make sure that the polarity is correct.

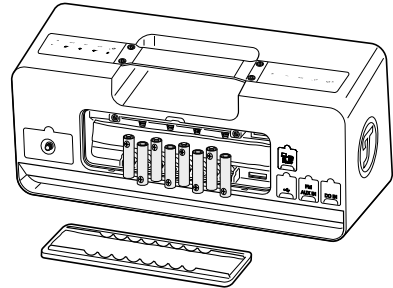

7. Close the battery compartment and tighten the screws.

Operation

CAUTION



Extended listening at high volumes may lead to hearing loss.

- *To avoid damage to health, avoid extended listening at high volumes.*
- *When the volume is set high, always keep a certain distance from the device and never place your ear directly on the speaker.*
- *If a speaker is set to full volume, this may produce very high sound pressure. This may have psychological consequences and also cause physical injury. Children and pets are particularly at risk. Set your signal source device volume control to a low setting before turning on the power.*

NOTICE

If the device is subjected to warm temperatures after being cold (e.g. after transport), condensation may occur inside of it.

- *In this case, wait at least 2 hours before you connect and activate it.*

Activating and deactivating

Activating

- Push and hold the  button (6) for approx. 2.5 seconds. The Boomster will switch on. “Teufel” will appear briefly on the display panel and it will then connect to the last active source.

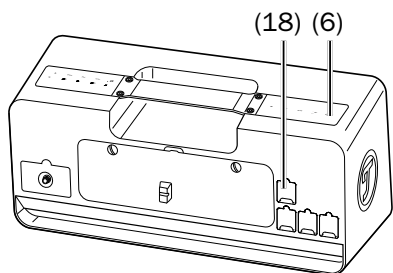

Deactivating

- Push and hold the  button (6) for approx. 2.5 seconds. The Boomster will switch
 - off in rechargeable battery mode,
 - to standby in mains operation mode.
- In case of prolonged non-use, turn the rechargeable battery switch (18) off (push it in). This will completely disconnect the rechargeable battery from the mains thus preventing a deep discharge.

Auto off

- The device will automatically deactivate if no input signal is received for 20 minutes.

Selecting a source

- With the (11), (12), (13) and (14) buttons, select the external player (Bluetooth or AUX) or radio mode (DAB+ or FM). The active source or the selected radio station will appear on the display panel (24).

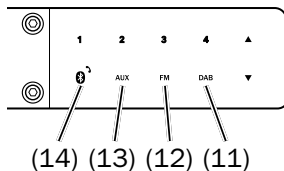

Volume

- You can decrease or increase the volume in 16 levels with the **-/+ buttons (8)**. When adjusting the volume, the volume that is currently selected will appear on the display panel (24).

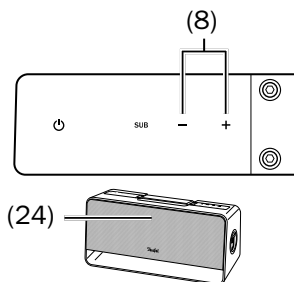

You can gradually adjust the volume by tapping. Pushing and holding will change the volume continuously. If the device has been muted (lowest volume), the notice “MUTE” will appear on the display panel.

Setting the subwoofer volume

1. Push the **SUB (7)** button to adjust the volume of the subwoofer to your own listening preferences, the music or setup location. The current setting will appear on the display panel (24).

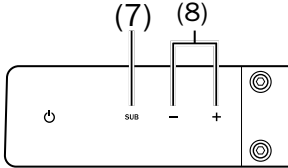

2. Now you can use the **-/+ buttons (8)** to adjust the volume of the subwoofer within a range of -6 dB to +6 dB.
3. To exit setup mode, you can push the **SUB button (7)** again. Otherwise, the mode will automatically end after approx. 5 seconds of key inactivity.

Radio

The Boomster is equipped with a radio for DAB+ and FM/USW. 4 memory slots are available for your favourite stations. The enclosed telescopic antenna (2) guarantees good reception.

Selecting the radio

1. To receive radio stations, always pull the antenna all the way out. If applicable, adjust its position for better reception later.
2. Briefly push the button for the desired reception range: **DAB (11)**: Reception of digital radio stations. **FM (12)**: Reception of analogue radio stations, RDS possible.

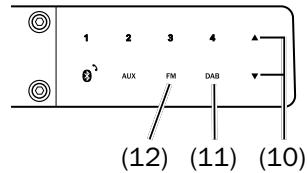

Setting stations

Set the stations with the buttons **▼/▲ (10)**:

- **DAB+**: Access the previous/next station by tapping the button.
- **FM**: Each time you tap the button, the receiving frequency will be decreased/increased by 50 kHz. Pushing and holding the button will start the forward or backward station scan. The scan will stop at the next station received in sufficient quality. If necessary, start the scan again until you have found the desired station.

The name of the set station appears on the display panel (24).

Saving and accessing stations

- If you would like to save the set station, push and hold one of the station buttons (9) for approx. 3 seconds.

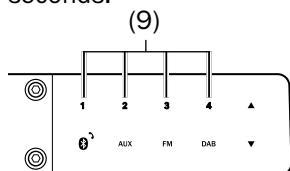

The notice “STORED” will appear briefly on the display panel. The station has now been saved to this station button.

- You can access the saved stations by briefly pushing the corresponding station button.

i FM reception may be affected slightly while charging the rechargeable battery pack.

AUX

Connection

The jack **AUX IN (16)** serves to connect an external player using a stereo cable with a 3.5 mm jack plug. You can connect any external players with a line-out jack or earphone jack.

Playback

1. Push the button **AUX (13)** to select the AUX input.

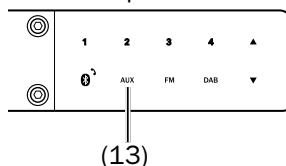

The notice “AUX” will appear on the display panel briefly.

2. Start playback on your external player.

i The volume setting of the external player affects the volume of the Boomster.

3. Control all playback functions via the external player.

Bluetooth®

Via Bluetooth®, you can establish a wireless connection between a compatible external player and the Boomster. The audio output of your external player is then emitted by the Boomster.

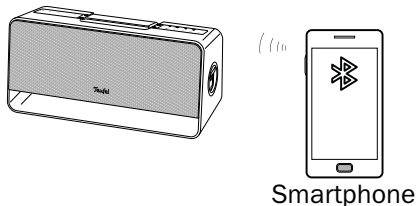

NOTICE

Only use the Bluetooth® function in locations where wireless radio transmission is allowed.

Please keep in mind that the Bluetooth® and NFC behaviour may differ depending on the external player's operating system.

Bluetooth® options

Depending on the device type, your external player/smartphone may also have a number of Bluetooth® options such as media playback and call function. Here you can activate and deactivate the desired options.

You can find more information about the Bluetooth® options in the user manual for your external player/smartphone.

Pairing

To play the audio of your external player on your Boomster via Bluetooth®, you must first connect the devices with each other. This is called “Pairing”. The Boomster provides manual and automatic pairing via NFC.

Manual pairing

1. Turn on the Bluetooth® function on your external player (e.g. smartphone).
2. Push the  (14) button and hold it for approx. 3 seconds.

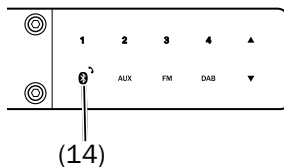

As soon as the notice “PAIRING” appears on the display panel (24), the external player can be paired.

3. Let your external player/smartphone scan for Bluetooth® devices. You will find more information about this in the user manual of your external player. “Teufel Boomster” should also appear in the list of detected devices following the scan.
4. Select “Teufel Boomster” from the list of detected devices. Pairing is now complete and your Boomster will now act as a Bluetooth® playback device. The Boomster will now play back all sounds that would otherwise be played by your external player/smartphone.

Pairing via NFC

NFC (Near Field Communication) is a transmission standard for the wireless exchange of data over short distances. Your Boomster can create a connection to a compatible external player via NFC.

1. Turn the NFC function on your external player on (Bluetooth® does not have to be turned on for the external player).
2. Hold your external player close to the NFC contact zone **N** (22) on the top side of the Boomster.

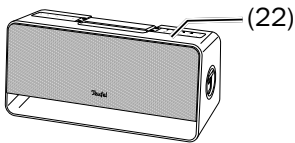

The Boomster will automatically switch to Bluetooth® mode. After a short time, you will be asked to allow the NFC connection on your external player.

3. Confirm the request on your external player. Pairing is now complete and your Boomster will now act as a Bluetooth® playback device. The Boomster will now play back all sounds that would otherwise be played by your external player/smartphone.

Playback

i The volume setting of the external player affects the volume of the Boomster. You can only adjust the sound on your Boomster.

- Start playback on your external player and also use it to control the other playback functions.

Call function

You can use the Boomster as a hands-free device for your smartphone.

- In the event of an incoming call, your smartphone will ring and the Boomster will also emit a ring tone. Any media playback will be paused.
- Tap the **☎** (14) button on the Boomster.
- Now you can answer the call with your Boomster via the integrated microphone.
- Push the **☎** button again to end the call.

Media playback will resume.

Terminating the Bluetooth connection

To terminate the Bluetooth® connection,

- deactivate the Bluetooth® function on your external player/smartphone.
- or push and hold the **☎ button** (14) for approx. 3 seconds causing the pairing to be terminated.

USB

The USB jack (17) supplies power and charges external players such as smartphones, tablets or MP3 players.

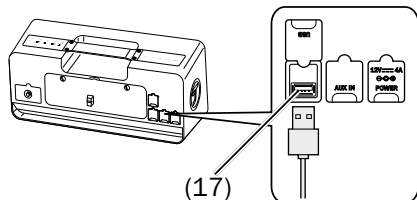

The charging process may, however, take longer with the Boomster than with the corresponding mains adapter.

NOTICE

Please note that charging a device may reduce the rechargeable battery life of your Boomster.

Remote Control

You can use the “Teufel Puck” remote control as an optional accessory. Available in our online shop.

Pairing the “Teufel Puck”

1. Switch the Boomster on.
2. Position the “Teufel Puck” at a distance of no more than 25 cm to the Boomster.
3. Hold the button (25) down until the LED ring (27) starts to blink. Then release the button.
 - Blinks three times: Pairing was successful.
 - Blinks ten times: Pairing failed and must be repeated.

Functions

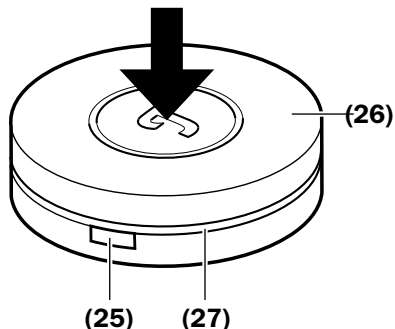

- **Switching the Boomster** or “Teufel Puck” on and off: Push and hold the ⌚ (26) for approx. 3 seconds. Tapping the ⌚ is sufficient to switch on from standby (only works in mains mode, not in battery mode).
- Selecting a source: Push the button ((25)) repeatedly.

- Adjusting the volume: Turn the cover (26).
- Mute: Tap the  (26).

Changing the batteries

The remote control is powered by 2 type AAA batteries. Simply pull off the cover to open the battery compartment.

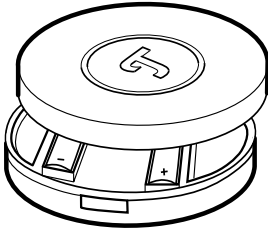

NOTICE

When inserting the batteries in the compartment, make sure that the polarity is correct.

CAUTION

Batteries (particularly lithium batteries) can explode if used improperly.

- Never attempt to recharge batteries.
- Only use batteries of the same or equivalent type.
- You must not heat, short circuit batteries and rechargeable batteries, dispose of them in fire or expose them to direct sunlight.

Leaking battery acid may lead to chemical burns.

- Do not allow battery acid to come into contact with skin, eyes or mucous membranes. In the event of contact with acid, immediately flush the applicable areas with plenty of clean water and consult a physician if necessary.

Care And Cleaning

NOTICE

External influences may damage or destroy the device.

- *If the device is to be left unattended for a prolonged period of time (e.g. during a vacation) or if a thunderstorm is forecast, pull the mains plug out of the socket. Otherwise, sudden overvoltage could cause the device to become defective.*
 - *In the event of prolonged absence, remove the batteries from the device. Leaked batteries may damage the device.*
 - *If possible, only use plain water without any additives. In case of stubborn marks, a mild soap solution may be used.*
- *Do not use caustic cleaning products, white spirit, thinners, petrol or similar under any circumstances. Such cleaning agents may damage the delicate surface of the housing.*
 - Ideally, you should remove dust or small amounts of dirt with a dry, smooth leather cloth.
 - Use a damp cloth to rub off stubborn dirt. Make sure that no liquid penetrates the housing.
 - Then immediately wipe the damp surfaces off with a soft cloth without applying pressure.

Troubleshooting

The following advice should help you to solve problems. If this does not work, our online manual will provide help:

<https://manual.teufelaudio.com>

Problem	Possible cause/solution
The Boomster doesn't emit sound.	Make sure that power is supplied. Check to make sure that the mains cord is securely seated. Recharge the rechargeable battery.
No sound.	The wrong source has been selected. Select the correct source (see page 13).
	The volume has been set too low. Increase the volume.
	The volume of the external player has been set too low. Carefully increase the volume of the external player.
No sound in Bluetooth® mode.	No Bluetooth® connection. Establish a connection (see „Bluetooth®“ on page 16).
	Boomster has not been selected as the output device. On the external player, select “Teufel Boomster” as the Bluetooth® output device.
	Bluetooth® connection impaired by another radio system (e.g. cordless telephone, Wi-Fi). Move the devices causing the disturbance.
The radio reception is noisy or cuts out.	Input signal is too weak. Pull the telescopic antenna all the way out. Adjust the position of the antenna. Place the Boomster in another location.

Technical Data

The following radio frequency bands and radio transmitting powers are used in this product:

Frequency bands in GHz	Max. transmission power in dBm
2.40535 GHz–2.47735 GHz	1 mW / 0 dBm

Operating temperature range 0–45 °C

Mains adapter

Power supply:	Input:	100-240 V~ 50/60 Hz
	Output:	12 V DC / 4 A / 48 W
Average efficiency:		89.50 %
Efficiency at low load 10%:		86.00 %
No load power consumption:		0.10 W

Boomster

Power supply:	12 V DC / 4 A
Dimensions (W×H×D)	370 × 180 × 143 mm
Weight	3.4 kg

Rechargeable battery pack

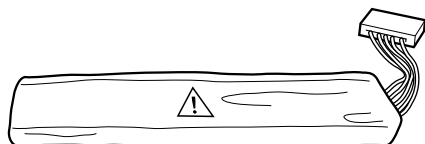

Voltage:	11.1 V
Nominal capacity	4400 mAh
Power rating	48,8 wh

You can find further technical data about the product on our website.

Declaration Of Conformity

CE Lautsprecher Teufel GmbH hereby declares that this product complies with the requirements of the directives 2014/30/EU, 2014/35/EU and 2014/53/EU to the extent they are installed and used in accordance with the instructions of the manufacturer. The full text of the EU declaration of conformity is available at the following Internet address:

www.teufelaudio.com/declaration-of-conformity.html

Teufel

Please contact our customer service department with any questions, suggestions, or complaints:

Lautsprecher Teufel GmbH
BIKINI Berlin
Budapester Straße 44
10787 Berlin (Germany)

Phone:

Denmark	+4589886335
Finland	+358753263952
Norway	+4781503272
The Netherlands	+31208083195
Sweden	+46108885284
United Kingdom	+443308080489
The rest of Europe	+800 200 300 40

Online support: www.teufelaudio.com/service

Contact form: www.teufelaudio.com/contact

No responsibility is assumed for the correctness of this information. Technical changes, typographical errors and other errors reserved.