

DENON[®]

AVC-A1H

INTEGRATED NETWORK AV AMPLIFIER

Owner's Manual

[Front panel](#)[Display](#)[Rear panel](#)[Remote](#)[Index](#)

Accessories	8
Inserting the batteries	9
Operating range of the remote control unit	9
Features	10
High quality sound	10
High performance	13
Easy operation	17
Part names and functions	18
Front panel	18
Display	22
Rear panel	24
Remote control unit	28

Connections

Speaker installation	32
Connecting speakers	38
Before connecting speakers	38
Connecting speakers to the speaker terminals	42
Connecting an external power amplifier	43
Speaker configuration and “Amp Assign” settings	45
Connecting 5.1-channel speakers	47
Connecting 7.1-channel speakers	48
Connecting 9.1-channel speakers	50
Connecting 11.1-channel speakers	53
Connecting 13.1-channel speakers	56
Connecting 15.1-channel speakers	59
Connecting 17.1-channel speakers	60
Bi-amp connection	61
Connecting 13.1-channel speakers : Second pair of front speakers	64
Connecting multi-zone speakers	65



Connecting a TV	69
Connection 1 : TV equipped with an HDMI connector and compatible with the ARC / eARC	70
Connection 2 : TV equipped with an HDMI connector and incompatible with the ARC / eARC	71
Connecting a playback device	72
Connecting a set-top box (Satellite tuner/cable TV)	73
Connecting a media player	74
Connecting a Blu-ray Disc player or DVD player	75
Connecting a game console or player device compatible with 8K	76
Connecting a turntable	77
Connecting a USB memory device to the USB port	78
Connecting to a home network (LAN)	79
Wired LAN	79
Wireless LAN	80
Connecting an external control device	81
REMOTE CONTROL jacks	81
TRIGGER OUT jacks	82
Connecting the power cord	83

Playback

Basic operation	85
Turning the power on	85
Selecting the input source	85
Adjusting the volume	86
Turning off the sound temporarily (Muting)	86
Playback a Blu-ray Disc player/DVD player	86
Playing a USB memory device	87
Playing files stored on USB memory devices	88
Listening to music on a Bluetooth device	91
Playing music from Bluetooth device	92
Pairing with other Bluetooth devices	93
Reconnecting to this unit from a Bluetooth device	94
Listening to audio on Bluetooth headphones	95
Listening to audio on Bluetooth headphones	96
Reconnecting to a Bluetooth headphones	97
Disconnecting Bluetooth headphones	97
Listening to Internet Radio	98
Listening to Internet Radio	99
Playing back files stored on a PC or NAS	100
Playing back files stored on a PC or NAS	101
Getting the HEOS App	104
HEOS Account	105
Playing from streaming music services	106
Listening to the same music in multiple rooms	109



AirPlay function	113	Selecting a sound mode	127
Playing songs from your iPhone, iPod touch or iPad	114	Selecting a sound mode	128
Playing iTunes music with this unit	114	Direct playback	129
Play a song from your iPhone, iPod touch or iPad on multiple synced devices (AirPlay 2)	115	Pure Direct playback	130
Spotify Connect function	116	Auto surround playback	130
Playing Spotify music with this unit	116	Description of sound mode types	131
Convenience functions	117	Sound mode that can be selected for each input signal	136
Adding to HEOS Favorites	118	HDMI Control function	141
Playing back HEOS Favorites	118	Setting procedure	141
Deleting a HEOS Favorites	119	Sleep timer function	142
Adjusting the audibility of dialog and vocals (Dialog Enhancer)	119	Using the sleep timer	143
Adjusting the volume of each channel to match the input source (Channel Level Adjust)	120	Quick select plus function	144
Adjusting the tone (Tone)	121	Calling up the settings	145
Adjusting audio delay (Audio Delay)	122	Changing the settings	146
Changing the strength of Tactile Transducer according to the input source (Tactile Transducer)	123	Panel lock function	148
Displaying your desired video during audio playback (Video Select)	124	Disabling all key button operations	148
Playing the same music in all zones (All Zone Stereo)	125	Disabling all button operations except VOLUME	148
Changing the speaker settings to match the listening environment (Speaker Preset)	126	Canceling the Panel lock function	149



Remote lock function	150
Disabling the sensor function of the remote control unit	150
Enabling the remote sensor function	150
Web control function	151
Controlling the unit from a web control	151
Playback in ZONE2/ZONE3 (Another room)	154
Connecting ZONE	155
Playback the source in ZONE2/ZONE3	159
Adjusting the Volume in ZONE2/ZONE3	163

Settings

Menu map	164
Menu operations	169
Audio	170
Subwoofer Level Adjust	170
Bass Sync	170
Surround Parameter	171
Restorer	179
Volume	180
Audyssey®	181
Graphic EQ	184

Video	186
HDMI Setup	186
Output Settings	191
On-Screen Display	193
Screensaver	194
4K/8K Signal Format	194
HDCP Setup	196
TV Format	196
Inputs	197
Input Assign	197
Source Rename	200
Hide Sources	200
Source Level	201
Speakers	202
Audyssey® Setup	202
Procedure for speaker settings (Audyssey® Setup)	204
Error messages	210
Retrieving Audyssey® Setup settings	212



Manual Setup	213	HEOS Account	251
Amp Assign	213	You have not signed in	251
Speaker Configuration	225	You have already signed in	251
Distances	234	General	252
Levels	235	Language	252
Crossovers	236	Owner's Manual	252
Bass	236	ECO	252
XLR Output Assign	237	Bluetooth Transmitter	256
Front Speaker	238	ZONE2 Setup / ZONE3 Setup	257
2ch Playback	238	Zone Rename	259
Tactile Transducer Setup	241	Quick Select Names	259
Speaker Connection	242	Trigger Out 1 / Trigger Out 2	260
Speaker Preset	242	Front Display	260
Network	243	Firmware	261
Information	243	Information	263
Connection	243	Usage Data	265
Wi-Fi Setup	244	Save & Load	266
Settings	246	Setup Lock	266
Network Control	247	Reset	267
Friendly Name	248	Setting the back light of the remote control unit	268
Diagnostics	248	Disabling the backlight	268
AirPlay	249	Specifying the zone used with the remote control unit	269
Spotify Connect	250		
Wi-Fi and Bluetooth	250		



Tips

Tips	271
Troubleshooting	273
Power does not turn on / Power is turned off	274
Operations cannot be performed through the remote control unit	275
Display on this unit shows nothing	275
No sound comes out	276
Desired sound does not come out	277
Sound is interrupted or noise occurs	281
No video is shown on the TV	282
The menu screen is not displayed on the TV	284
The color of the menu screen and operations content displayed on the television is different from normal	284
AirPlay cannot be played back	285
USB memory devices cannot be played back	286
Bluetooth cannot be played back	287
The Internet radio cannot be played back	289
Music files on PC or NAS cannot be played back	290
Various online services cannot be played	291
The HDMI Control function does not work	291
Cannot connect to a wireless LAN network	292
When using HDMI ZONE2, the devices does not function properly	293
Update error messages	294

Resetting factory settings	295
Resetting network settings	296
Restoring the firmware to the factory defaults	297

Appendix

About HDMI	298
Relationship between video signals and monitor output	302
Playing back a USB memory devices	304
Playing back a Bluetooth device	305
Playing back a file saved on a PC or NAS	306
Playing back Internet Radio	307
Personal memory plus function	307
Last function memory	307
Sound modes and channel output	308
Sound modes and surround parameters	310
Types of input signals, and corresponding sound modes	313
Explanation of terms	317
Trademark information	328
Specifications	332
Index	338







Thank you for purchasing this Denon product.

To ensure proper operation, please read this owner's manual carefully before using the product.

After reading this manual, be sure to keep it for future reference.

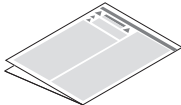
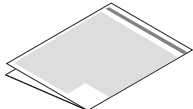
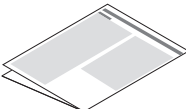
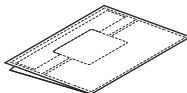
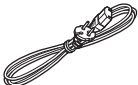
Accessories

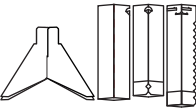
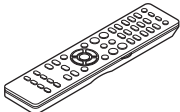
Check that the following parts are supplied with the product.

 <p>Quick Start Guide</p>	 <p>Safety Instructions</p>	 <p>Cautions on Using Batteries</p>	 <p>Notes on radio</p>	 <p>Cable labels</p>
 <p>Power cord</p>	 <p>Sound calibration microphone</p>	 <p>Sound calibration microphone stand</p>	 <p>Remote control unit (RC-1250)</p>	 <p>2x R03/AAA batteries</p>
 <p>External antennas for Bluetooth/wireless connectivity</p>				



Inserting the batteries

- 1 Remove the rear lid in the direction of the arrow and remove it.



- 2 Insert two batteries correctly into the battery compartment as indicated.

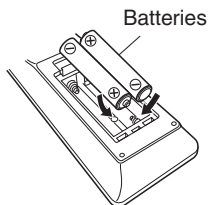

- 3 Put the rear cover back on.

NOTE

- To prevent damage or leakage of battery fluid:
 - Do not use a new battery together with an old one.
 - Do not use two different types of batteries.
- Remove the batteries from the remote control unit if it will not be in use for long periods.
- If the battery fluid should leak, carefully wipe the fluid off the inside of the battery compartment and insert new batteries.

Operating range of the remote control unit

Point the remote control unit at the remote sensor when operating it.

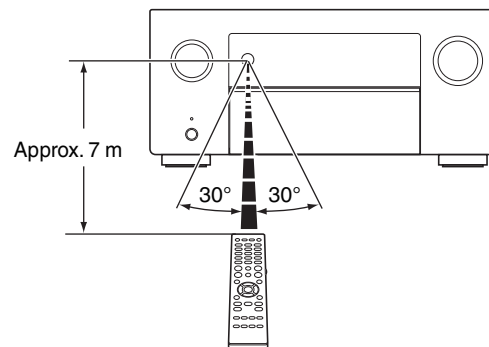

Features

High quality sound

- **The Ultimate 15.4-channel Home Theater Experience**

Featuring Denon's most advanced and sophisticated power amplifier design, this unit delivers high-power performance at 140 watts per channel (8 Ω /ohms, 20 Hz - 20 kHz, T.H.D.: 0.05 %, 2ch. driven) to ensure a dynamic and precise entertainment experience. Low impedance drivers provide operational stability for a wide range of speakers and create a balanced, tonal sound.

- **Discrete 4 subwoofers**

Immerse yourself in evenly distributed, accurate bass. Featuring up to four subwoofer outputs to smooth out low frequencies and provide better dispersion. No audible peaks or dips - just powerful, room-filling bass.

- **Dolby Atmos (🔊 p. 318)**

This unit is equipped with a decoder that supports Dolby Atmos audio format. The placement or movement of sound is accurately reproduced by the addition of overhead speakers, enabling you to experience an incredibly natural and realistic surround sound field.

- **Speaker Virtualizer (🔊 p. 173)**

Speaker Virtualizer enables you to access a more immersive entertainment experience from traditional channel based speaker layouts through digital signal processing including Dolby Atmos height virtualization and surround virtualization.

- Speaker Virtualizer is not for use when both height speakers and surround speakers are connected.
- Height Virtualization may be applied when surround speakers are connected.

- **DTS:X Pro**

This unit is equipped with the DTS:X Pro decoder technology. DTS:X Pro decoder brings the home theater experience to new heights with its immersive object based audio technology which removes the bounds of channels. Enjoy up to 15.1-channels of audio processing with DTS:X Pro to enjoy a full surround sound in exquisite detail.

- **DTS Virtual:X (🔊 p. 322)**

DTS Virtual:X technology features DTS's proprietary virtual height and virtual surround processing to deliver an immersive sound experience from any type of input source (stereo to 7.1.4 channel) and speaker configuration.

- DTS Virtual:X is not for use when Height speakers are connected.



- **IMAX Enhanced** (🔍 p. 322)

This IMAX Enhanced product have met stringent performance standards established by IMAX and DTS in order to create a consistent and higher bar for sound performance. DTS has developed a special method for reproducing an IMAX signature sound experience in the consumer's home. This method combines a unique conversion process for IMAX theatrical audio mixes utilizing an enhanced DTS codec technology. The IMAX theatrical audio format with point source surround speakers closely matches the speaker configuration most consumers have in their homes today. Coupled with DTS audio technology, IMAX Enhanced audio products will ensure the best and most accurate audio reproduction over 5.1 or more speaker channels.

- **Audyssey LFC™ (Low Frequency Containment)** (🔍 p. 183)

Audyssey LFC™ solves the problem of low frequency sounds disturbing people in neighboring rooms or apartments. Audyssey LFC™ dynamically monitors the audio content and removes the low frequencies that pass through walls, floors and ceilings. It then applies psychoacoustic processing to restore the perception of low bass for listeners in the room. The result is great sound that no longer disturbs the neighbors.

- **Discrete subwoofers and Audyssey Sub EQ HT™** (🔍 p. 203)

The unit has four subwoofer output capability and can adjust the level and delay for each subwoofer individually. Audyssey Sub EQ HT™ makes the integration seamless by first compensating for any level and delay differences between the four subwoofers and then applying Audyssey MultEQ® XT32 to four subwoofers together for improved deep bass response and detail.



- **Auro-3D**

This unit is equipped with an Auro-3D decoder.

With Auro-3D, Front Height (FHL + FHR), Surround Height (SHL + SHR), Center Height (CH/optional) and Top Surround (TS/optional) are added to a conventional 5.1-channel system to achieve a natural and realistic sound field that is three-dimensional and fully immersive.

You will be able to fully enjoy Auro-3D playback if you properly place the speakers for Auro-3D.

■ Auro-3D playback

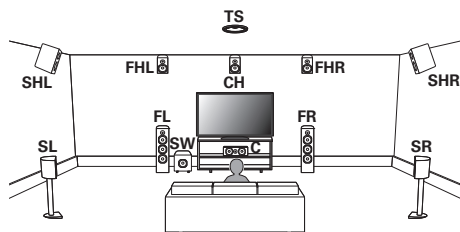

■ Dolby Atmos playback

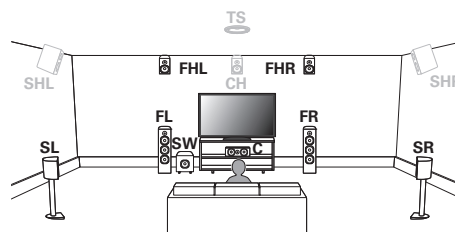

- Auro-3D does not support a Dolby Atmos configuration using Top Front, Top Middle or Top Rear speakers. But it is possible to support both an Auro-3D and Dolby Atmos by adding Front Height and Rear Height speakers* to a 5.1 configuration.

* For an optimum Auro-3D experience Surround Height speakers are strongly recommended.



High performance

- **Ultimate Home Theater Experience – 8K Ready**

This unit delivers the ultimate home theater experience with 8K/60Hz pass-through, 4K/120Hz pass-through for gaming, and support for the latest HDMI specifications. This unit allows you to build the best 4K home theater system, and offers the convenience of knowing that the used AV receiver is ready for 8K format whenever the user decides to use it.

Enjoy the highest quality 3D audio and video for even the most demanding entertainment needs.

- **HDCP 2.3**

This unit is compatible with HDCP 2.3 copyright protection standard.

- **Digital video processor upscales 1080p / 4K to 8K**

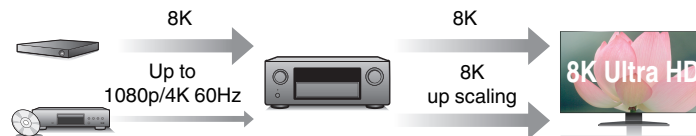

This unit is equipped with a 8K video upscaling function that allows 1080p/4K video to be output via HDMI at 8K (7680 × 4320 pixels) resolution. This function enables the device to be connected to a TV using a single HDMI cable, and produces high definition images for any video source.

- **eARC (Enhanced Audio Return Channel) function compatibility**

The eARC function is compatible with conventional ARC function-compatible audio formats in addition to multichannel linear PCM, Dolby TrueHD, Dolby Atmos, DTS-HD, DTS:X and other audio formats a conventional ARC function cannot transmit.

Additionally, connecting to an eARC function-compatible television enables enjoyment of higher-quality surround playback of the audio content played from your television.



- **Equipped with HDMI ZONE2 output** (👉 p. 154)

The ZONE2 multi-room output includes an HDMI output that lets you enjoy a different A/V source in that room, with another program playing in the main room.

- **HDMI connections enable connection to various digital AV devices (7 inputs, 3 outputs)**

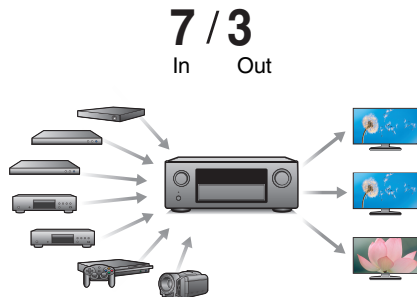

This unit is equipped with 7 HDMI inputs enabling connection to various HDMI compatible devices such as Blu-ray Disc players, game consoles and HD video camcorders. There are dual HDMI outputs for the main room, and a third HDMI output for another room.

- **The device is equipped with a AirPlay® function in addition to network functions such as Internet radio etc.** (👉 p. 113)

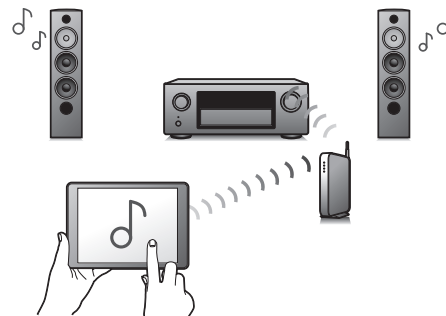

You can enjoy a wide variety of content, including listening to Internet Radio, playing audio files stored on your PC.

This unit also supports Apple AirPlay which lets you stream your music library from an iPhone®, iPad®, iPod touch® or iTunes®.

- **Supports AirPlay 2® wireless audio**

Sync multiple AirPlay 2 compatible devices/speakers for simultaneous playback.

This unit supports AirPlay 2 and requires iOS 11.4 or later.



- **Playback of DSD and FLAC files via USB and networks**

This unit supports the playback of high resolution audio formats such as DSD (5.6 MHz) and FLAC 192 kHz files. It provides high quality playback of high resolution files.

- **Wireless connection with Bluetooth devices can be carried out easily (☞ p. 91)**

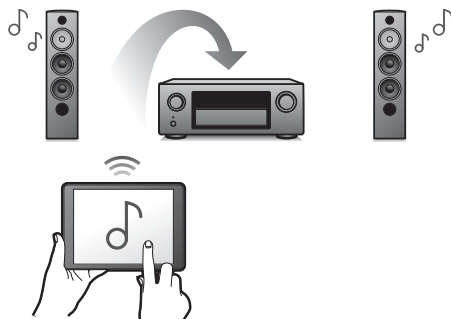

You can enjoy music simply by connecting wirelessly with your smartphone, tablet, PC, etc.

- **Connect Bluetooth headphones**

This unit can transmit Bluetooth so you can enjoy audio wirelessly through your Bluetooth headphones.

Playback can be performed using connected speakers and Bluetooth headphones simultaneously, or only using Bluetooth headphones.

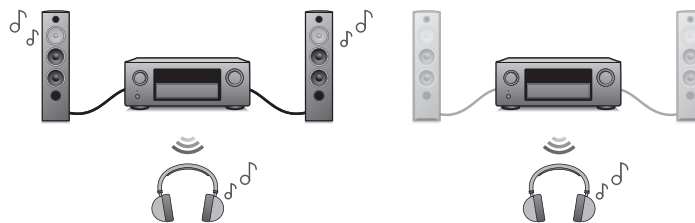

- **Multi-Room audio** (🔊 p. 125)

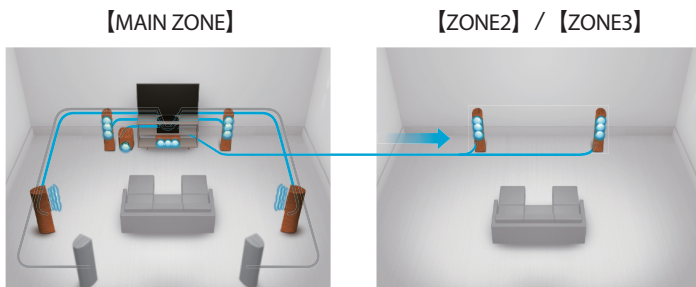

You can select and play back the respective inputs in MAIN ZONE, ZONE2 and ZONE3.

In addition, when the All Zone Stereo function is used, the music being played back in MAIN ZONE can be enjoyed in all the zones at the same time. This is useful when you want to let the background music propagate throughout the whole house.

- **Energy-saving design**

This unit is equipped with an ECO Mode function that allows you to enjoy music and movies while reducing the power consumption during use, and also an auto-standby function that automatically turns off the power supply when the unit is not in use. This helps reduce unnecessary power use.

- **Compatible with the “Denon AVR Remote” App* for performing basic operations of the unit with an iPad, iPhone or Android™ devices (Google, Amazon Kindle Fire)**

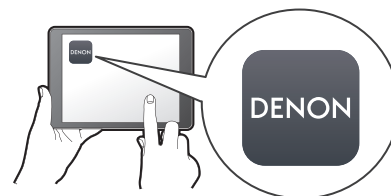

The Denon AVR Remote app gives you full control of this unit as well as access to its setup menu for detailed adjustments from your phones or tablets. “Denon AVR Remote” App also gives you quick access to the receiver’s status display, option menus, Denon Blu-ray Disc player control, and online owner’s manual for your convenience.

* Download the appropriate “Denon AVR Remote” App for your iOS or Android devices. This unit needs to be connected to the same LAN or Wi-Fi (wireless LAN) network that the iPad, iPhone or Android™ is connected to.



- HEOS provides streaming music from your favorite online music sources

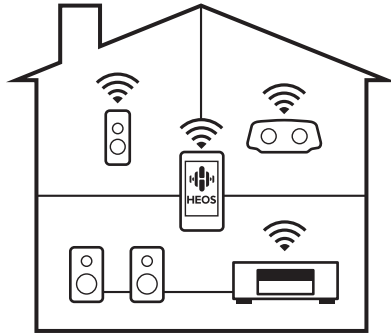

HEOS wireless multi-room sound system that enables you to enjoy your favorite music anywhere and everywhere around your home. By utilizing your existing home network and the HEOS App (available for iOS, Android and Amazon devices), you can explore, browse, and play music from your own music library or from many online streaming music services.

When multiple products with HEOS Built-in are connected to the same network, they can be grouped to play the same music on all products simultaneously, or different music can be played on each one.

Easy operation

- **“Setup Assistant” provides easy-to-follow setup instructions**
First select the language when prompted. Then simply follow the instructions displayed on the TV screen to set up the speakers, network, etc.
- **Easy to use Graphical User Interface**
This unit is equipped with a Graphical User Interface for improved operability.



Part names and functions

Front panel

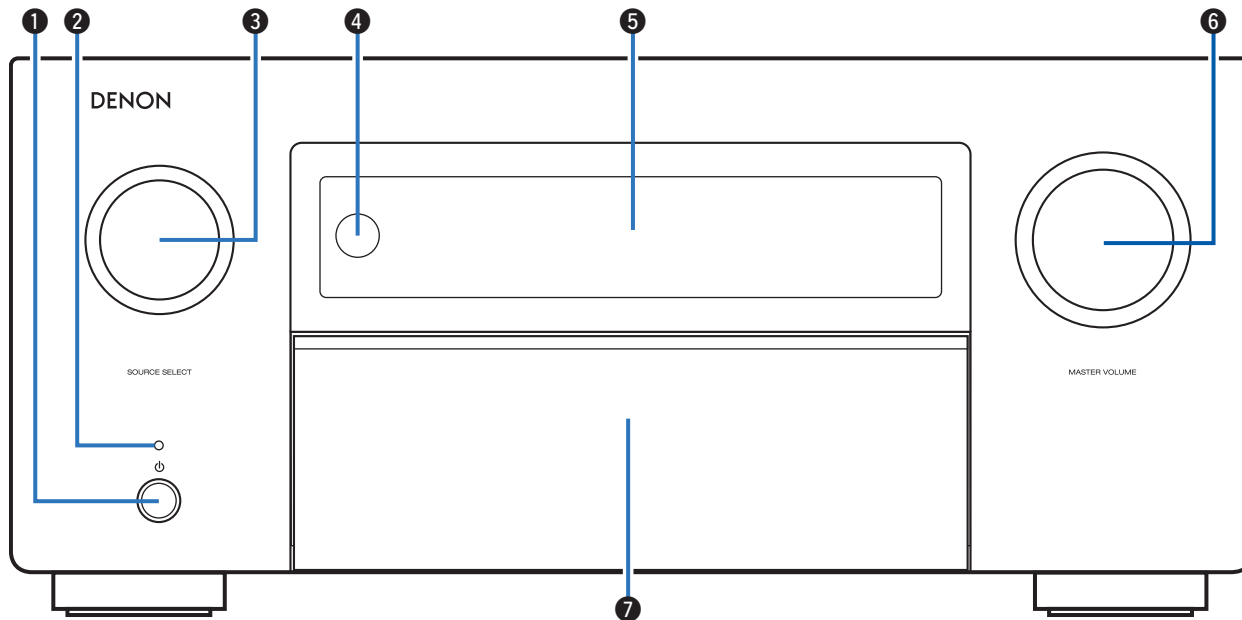

For details, see the next page.



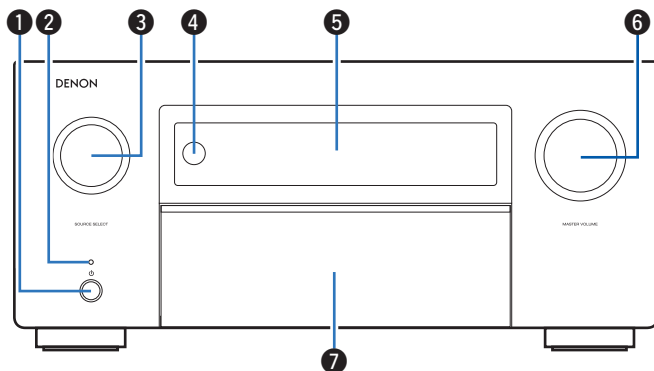

1 Power operation button (⏻)

Used to turn the power of the MAIN ZONE (room where this unit is located) on/off (standby). (👉 p. 85)

2 Power indicator

This is lit as follows according to the power status:

- Green: Power on
- Off: Normal standby
- Red:
 - When “HDMI Pass Through” is set to “On” (👉 p. 186)
 - When “HDMI Control” is set to “On” (👉 p. 188)
 - When “Network Control” is set to “Always On” (👉 p. 247)

3 SOURCE SELECT knob

This selects the input source. (👉 p. 85)

4 Remote control sensor

This receives signals from the remote control unit. (👉 p. 9)

5 Display

This displays various pieces of information. (👉 p. 22)

6 MASTER VOLUME knob

This adjusts the volume level. (👉 p. 86)

7 Door

When you are using buttons and/or connectors behind the door, press the bottom of the door to open it. Be careful not to catch your fingers when closing the door.

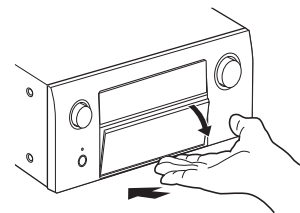

With the door open

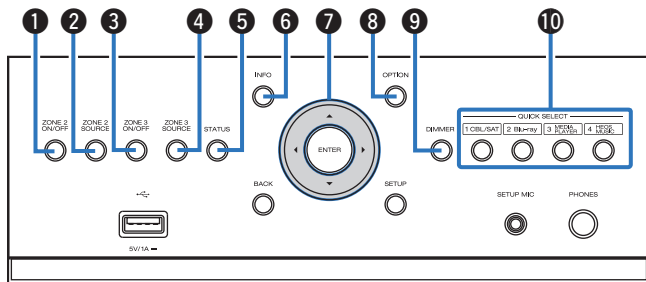

1 ZONE2 ON/OFF button

This turns the power of ZONE2 (another room) on/off. (👉 p. 159)

2 ZONE2 SOURCE button

This selects the input source for ZONE2. (👉 p. 159)

3 ZONE3 ON/OFF button

This turns the power of ZONE3 (another room) on/off. (👉 p. 159)

4 ZONE3 SOURCE button

This selects the input source for ZONE3. (👉 p. 159)

5 STATUS button

Each press of this switches the status information that is shown on the display.

6 Information button (INFO)

This displays the status information on the TV screen. (👉 p. 264)

7 Cursor buttons

These select items.

8 OPTION button

This displays the option menu on the TV screen.

9 DIMMER button

Each press of this switches the brightness of the display. (👉 p. 260)

10 QUICK SELECT buttons

With a single press of any of these buttons, you can call up various settings you've registered to each button such as the input source, volume level and sound mode settings. (👉 p. 144)



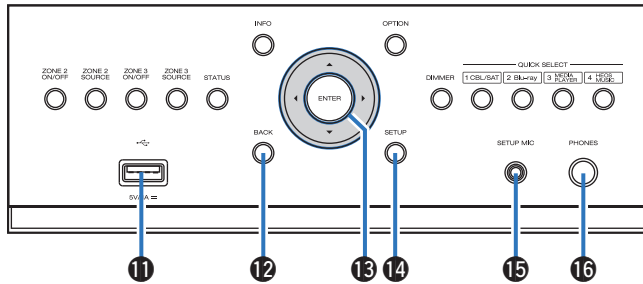

11 USB port (🔌)

This is used to connect USB storages (such as USB memory devices).
(👉 p. 78)

12 BACK button

This returns to the previous screen.

13 ENTER button

This determines the selection.

14 SETUP button

This displays the menu on the TV screen. (👉 p. 169)

15 SETUP MIC jack

This is used to connect the supplied Sound calibration microphone.
(👉 p. 205)

16 Headphones jack (PHONES)

This is used to connect headphones.

When the headphones are plugged into this jack, audio will no longer be output from the connected speakers or from the PRE OUT connectors.

NOTE

- To prevent hearing loss, do not raise the volume level excessively when using headphones.



Display

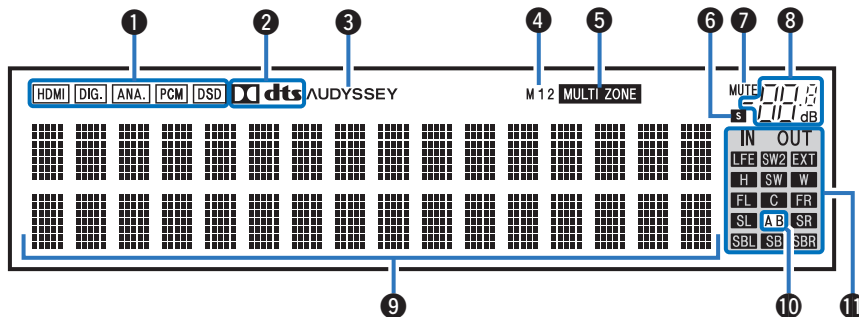

1 Input signal indicators

These light according to the audio input mode settings of each input source. (👉 p. 199)

2 Decoder indicators

These light when Dolby or DTS signals are input or when the Dolby or DTS decoder is running.

3 Audyssey® indicator

This lights when “MultEQ® XT32”, “Dynamic EQ”, “Dynamic Volume” or “Audyssey LFC™” has been set up. (👉 p. 181)

4 Monitor output indicator

These light according to the HDMI monitor output setting. When set to “Auto(Dual)”, the indicators light according to connection status.

5 MULTI ZONE indicator

This lights up when ZONE2 or ZONE3 (another room) power is turned on. (👉 p. 161)



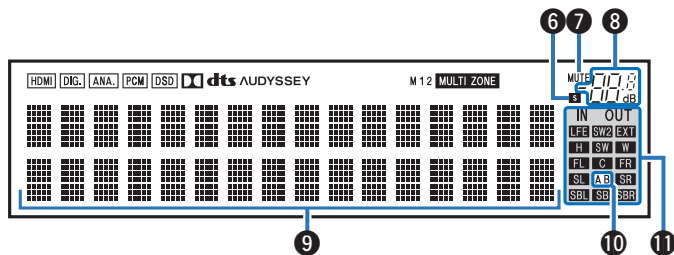

6 Sleep timer indicator

This lights when the sleep mode is selected. (👉 p. 142)

7 MUTE indicator

This blinks while the sound is muted. (👉 p. 86)

8 Volume indicator

9 Information display

The input source name, sound mode, setting values and other information are displayed here.

10 Front speaker indicator

This lights according to the setting of the front A and B speakers.

11 Input/output signal channel indicators

The channel for input/output signals is displayed according to the setting configured for “Channel Indicator”. (👉 p. 261)

- When “Channel Indicator” is set to “Output” (Default)
These light when audio signals are being output from the speakers.
- When “Channel Indicator” is set to “Input”
These light corresponding to the channels that include the input signals.

When playing HD Audio sources, the **EXT** indicator lights when a signal from an extension channel (a channel other than the front, center, surround, surround back, front height, front wide or LFE channel) is input.



Rear panel

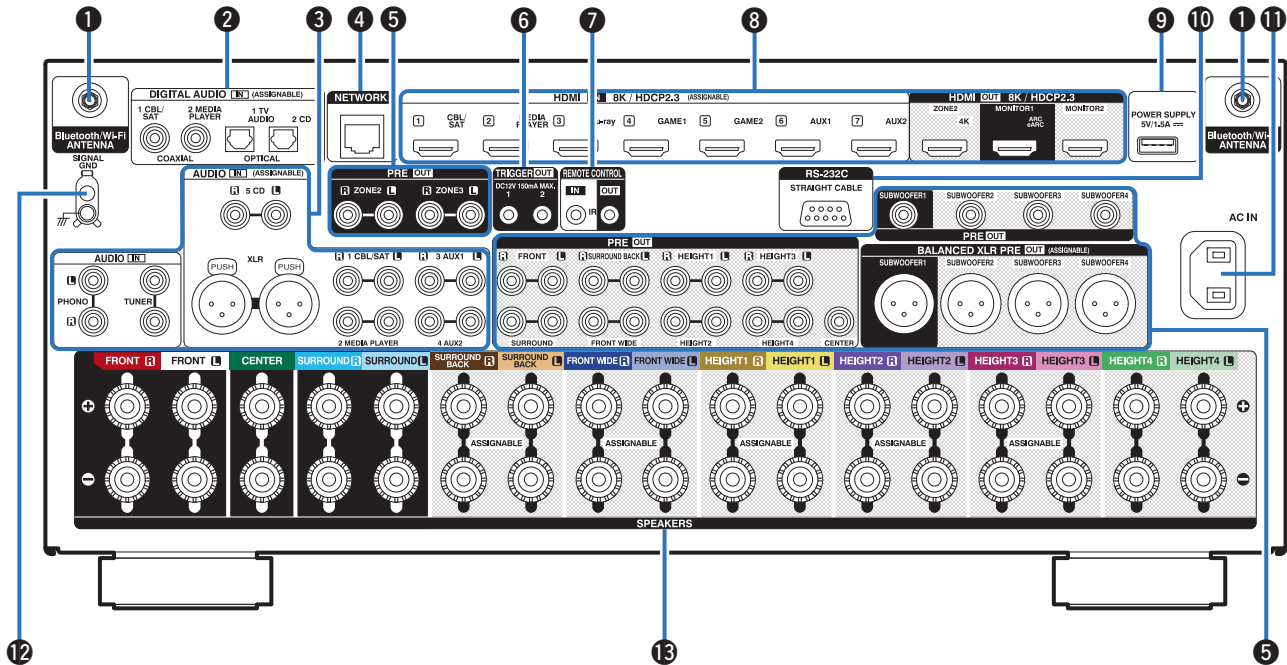

For details, see the next page.



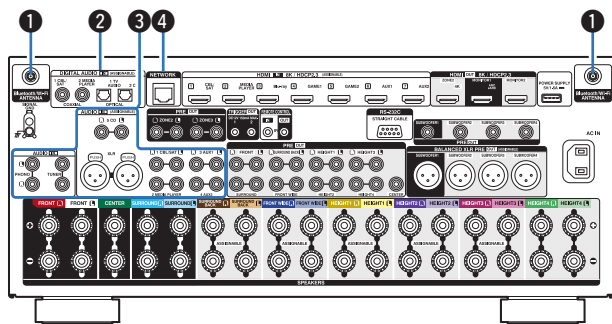

1 Bluetooth/wireless LAN antenna connectors

Used to connect the included external antennas for Bluetooth/wireless connectivity when connecting to a network via wireless LAN, or when connecting to a handheld device via Bluetooth. (☞ p. 80)

- ① Place the external antennas for Bluetooth/wireless connectivity evenly over the screw terminal of rear.
- ② Turn clockwise until the antennas is fully connected.
- ③ Rotate the antenna upwards for best reception.

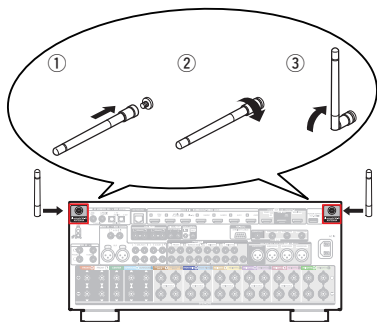

2 Digital audio connectors (DIGITAL AUDIO)

Used to connect devices equipped with digital audio connectors.

- “Connection 2 : TV equipped with an HDMI connector and incompatible with the ARC / eARC” (☞ p. 71)
- “Connecting a set-top box (Satellite tuner/cable TV)” (☞ p. 73)
- “Connecting a media player” (☞ p. 74)

3 Analog audio connectors (AUDIO)

Used to connect devices equipped with analog audio connectors.

- “Connecting a set-top box (Satellite tuner/cable TV)” (☞ p. 73)
- “Connecting a media player” (☞ p. 74)
- “Connecting a turntable” (☞ p. 77)

4 NETWORK connector

Used to connect to a LAN cable when connecting to a wired LAN network. (☞ p. 79)



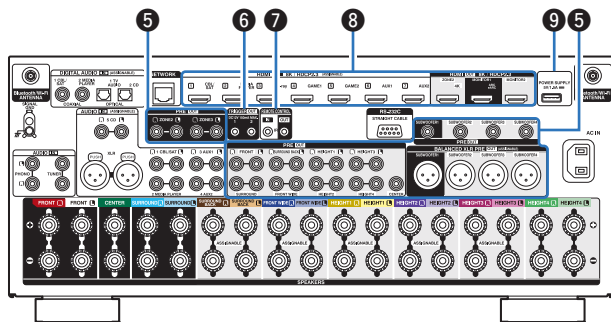

5 PRE OUT connectors

Used to connect a subwoofer with built-in amplifier or an external power amplifier.

- “Connecting the subwoofer” (☞ p. 39)
- “Connecting an external power amplifier” (☞ p. 43)
- “Connecting 11.1-channel speakers” (☞ p. 53)
- “Connecting 13.1-channel speakers” (☞ p. 56)
- “Connecting 15.1-channel speakers” (☞ p. 59)
- “Connecting ZONE” (☞ p. 155)

6 TRIGGER OUT jacks

Used to connect devices equipped with the trigger function.
(☞ p. 82)

7 REMOTE CONTROL jacks

Used to connect infrared receivers/transmitters in order to operate this unit and external devices from a different room. (☞ p. 81)

8 HDMI connectors

Used to connect devices equipped with HDMI connectors.

- “Connection 1 : TV equipped with an HDMI connector and compatible with the ARC / eARC” (☞ p. 70)
- “Connection 2 : TV equipped with an HDMI connector and incompatible with the ARC / eARC” (☞ p. 71)
- “Connecting a set-top box (Satellite tuner/cable TV)” (☞ p. 73)
- “Connecting a media player” (☞ p. 74)
- “Connecting a Blu-ray Disc player or DVD player” (☞ p. 75)
- “Connecting a game console or player device compatible with 8K” (☞ p. 76)

9 USB port (POWER SUPPLY)

Can be used to power streaming media players, etc.



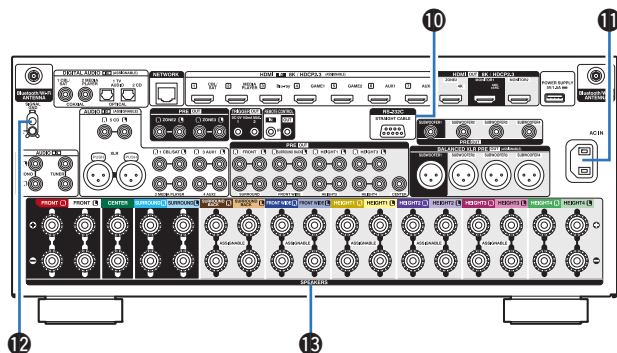

10 RS-232C connector

Used to connect home automation controller devices fitted with RS-232C connectors. Consult the owner's manual of the home automation controller for more information about serial control of this unit.

Perform the operation below beforehand.

- ① Turn on the power of this unit.
- ② Turn off the power of this unit from the external controller.
- ③ Check that the unit is in the standby mode.

11 AC inlet (AC IN)

Used to connect the power cord. (☞ p. 83)

12 SIGNAL GND terminal

Used to connect a ground wire for the turntable. (☞ p. 77)

13 Speaker terminals (SPEAKERS)

Used to connect speakers. (☞ p. 38)

NOTE

- Do not touch the inner pins of the connectors on the rear panel. Electrostatic discharge may cause permanent damage to the unit.



Remote control unit

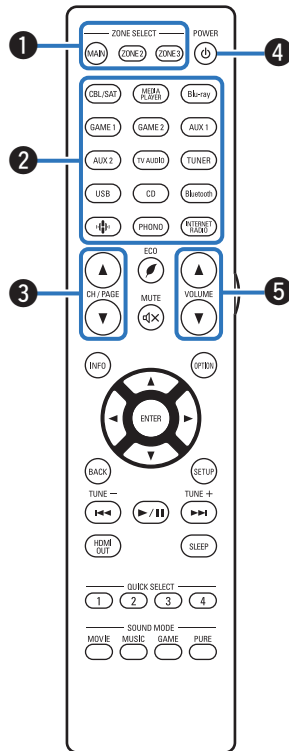

1 ZONE SELECT buttons (MAIN, Z2, Z3)

These switch the zone (MAIN ZONE, ZONE2, ZONE3) that is operated through the remote control unit.

- “Playback in ZONE2/ZONE3” (👉 p. 161)
- “Menu operations” (👉 p. 169)
- “Specifying the zone used with the remote control unit” (👉 p. 269)

2 Input source select buttons

These select the input source.

- “Selecting the input source” (👉 p. 85)
- “Playback in ZONE2/ZONE3” (👉 p. 161)

3 Channel/page search buttons (CH/PAGE ▲▼)

These switch pages. (👉 p. 99)

4 POWER button (⏻)

This turns the power on/off.

- “Turning the power on” (👉 p. 85)
- “Playback in ZONE2/ZONE3” (👉 p. 161)

5 VOLUME buttons (▲▼)

These adjust the volume level.

- “Adjusting the volume” (👉 p. 86)
- “Adjusting the Volume in ZONE2/ZONE3” (👉 p. 163)



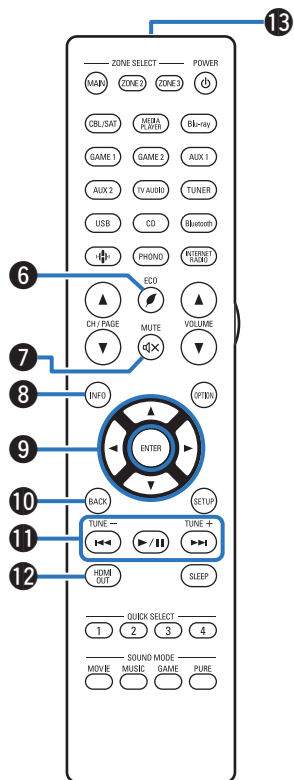

6 ECO Mode button (🔌)

This switches to ECO Mode. (👉 p. 252)

7 MUTE button (🔇)

This mutes the output audio.

- “Turning off the sound temporarily (Muting)” (👉 p. 86)
- “Turning off the sound temporarily (Muting)” (👉 p. 163)

8 Information button (INFO)

This displays the status information on the TV screen. (👉 p. 264)

9 Cursor buttons

These select items.

10 BACK button

This returns to the previous screen.

11 System buttons

These perform playback related operations.

12 HDMI OUT button

This sets the HDMI monitor output. (👉 p. 191)

13 Remote control signal transmitter

This transmits signals from the remote control unit. (👉 p. 9)



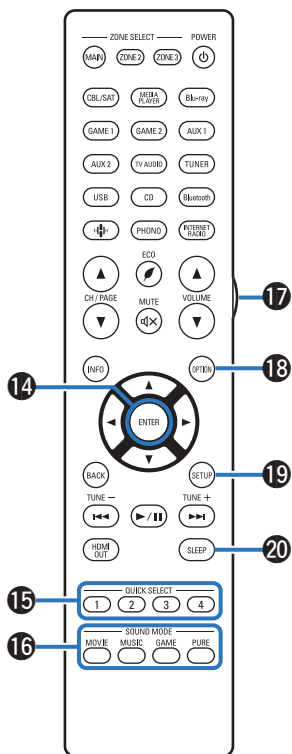

14 ENTER button

This determines the selection.

15 QUICK SELECT buttons (1 – 4)

These call up settings registered to each button, such as input source, volume level and sound mode settings. (☞ p. 144)

16 SOUND MODE buttons

These select the sound mode. (☞ p. 127)

17 Light button

This turns on the backlight for approx. 5 seconds. (☞ p. 268)

18 OPTION button

This displays the option menu on the TV screen.

19 SETUP button

This displays the menu on the TV screen. (☞ p. 169)

20 SLEEP button

This sets the sleep timer. (☞ p. 142)



■ Contents







Speaker installation	32
Connecting speakers	38
Connecting a TV	69
Connecting a playback device	72
Connecting a USB memory device to the USB port	78
Connecting to a home network (LAN)	79
Connecting an external control device	81
Connecting the power cord	83

NOTE

- Do not plug in the power cord until all connections have been completed. However, when the “Setup Assistant” is running, follow the instructions in the “Setup Assistant” (page 9 in the separate “Quick Start Guide”) screen for making connections. (During “Setup Assistant” operation, the input/output connectors do not conduct current.)
- Do not bundle power cords together with connection cables. Doing so can result in noise.

■ Cables used for connections

Provide necessary cables according to the devices you want to connect.

Speaker cable	
Subwoofer cable	
HDMI cable	
Coaxial digital cable	
Optical cable	
Audio cable	
LAN cable	



Speaker installation

Determine the speaker system depending on the number of speakers you are using and install each speaker and subwoofer in the room. Speaker installation is explained using this example of a typical installation.

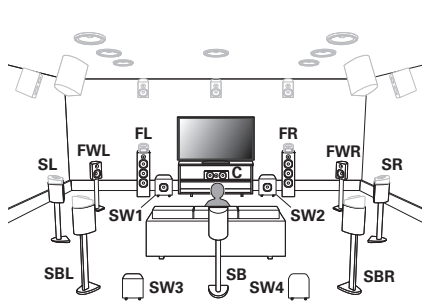

FL/FR
(Front speaker left/
right):

Place the FRONT left and right speakers an equal distance from the main listening position. The distance between each speaker and your TV should also be the same.

C
(Center speaker):

Place the CENTER speaker in between the front speakers and above or below your TV.

SL/SR
(Surround speaker left/
right):

Place the SURROUND left and right speakers an equal distance to the left and right sides of the main listening position. If you don't have surround back speakers, move the surround speakers slightly behind your listening position.

SBL/SBR
(Surround back
speaker left/right):

Place the SURROUND BACK left and right speakers an equal distance from the main listening position and directly behind the main listening position. When using a single surround back speaker (SB), place it directly behind the listening position.

FWL/FWR
(Front wide speaker
left/right):

Place the FRONT WIDE left and right speakers outside of the front left and right speakers so that there is an equal distance between all front speakers.

SW 1/2/3/4
(Subwoofer):

Place your subwoofer near your front speakers. If you are using multiple subwoofers, place pairs of subwoofers spaced equally across the front or rear walls of the room or place single subs midway between the front pairs or rear pairs. You can also set a specific layout when using multiple subwoofers on the "Subwoofer Mode" setting (🔧 p. 226):

2 subwoofers: 2 front, or 1 front and 1 rear
3 subwoofers: 2 front and 1 rear
4 subwoofers: 2 front and 2 rear



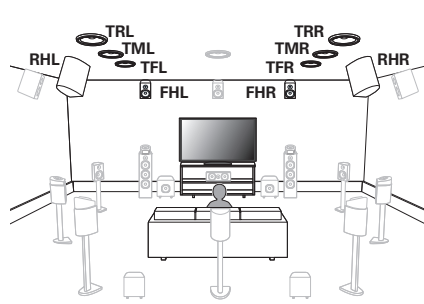

FHL/FHR
(Front height speaker
left/right):

Place the FRONT HEIGHT left and right speakers directly above the front speakers. Mount them as close to the ceiling as possible and aim them towards the main listening position.

TFL/TFR
(Top front speaker
left/right):

Mount the TOP FRONT left and right speakers on the ceiling slightly in front of your main listening position and aligned with the left and right front speakers.

TML/TMR
(Top middle speaker
left/right):

Mount the TOP MIDDLE left and right speakers directly above the main listening position and aligned with the left and right front speakers.

TRL/TRR
(Top rear speaker
left/right):

Mount the TOP REAR left and right speakers on the ceiling slightly behind your main listening position and aligned with the left and right front speakers.

RHL/RHR
(Rear height speaker
left/right):

Place the REAR HEIGHT left and right speakers directly behind the main listening position. Mount them as close to the ceiling as possible and aligned with the left and right front speakers.

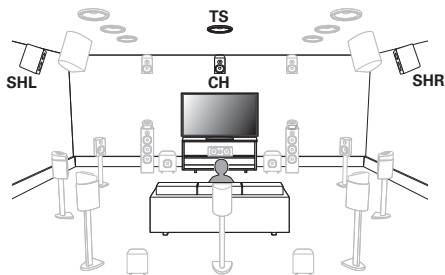

**SHL/SHR**

(Surround height speaker left/right):

Place the SURROUND HEIGHT left and right speakers directly above the surround speakers.

CH

(Center height speaker):

Place the CENTER HEIGHT speaker directly above the center speaker. Mount them as close to the ceiling as possible and aim them towards the main listening position.

TS

(Top surround speaker):

Place the TOP SURROUND speaker directly above the main listening position and aligned with the center channel speaker.



- For the best Auro-3D experience Surround Height speakers are recommended, however you may substitute Rear Height speakers from a Dolby Atmos speaker setup in place of Surround Height speakers.



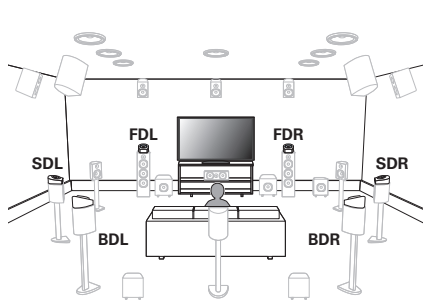

FDL/FDR
(Front Dolby speaker
left/right):

Place the FRONT Dolby Atmos Enabled speaker on the front speaker. For a Dolby Atmos Enabled (Front Dolby speaker integrated with a front speaker, place the Dolby Atmos Enabled speaker instead of the front speaker.

SDL/SDR
(Surround Dolby
speaker left/right):

Place the SURROUND Dolby Atmos Enabled speaker on the surround speaker. For a Dolby Atmos Enabled speaker integrated with a surround speaker, place the Dolby Atmos Enabled speaker instead of the surround speaker.

BDL/BDR
(Back Dolby speaker
left/right):

Place the BACK Dolby Atmos Enabled speaker on the surround back speaker. For a Dolby Atmos Enabled speaker integrated with a surround back speaker, place the Dolby Atmos Enabled speaker instead of the surround back speaker.

About Dolby Atmos Enabled speakers

Dolby Atmos Enabled speakers reflect the sound off the ceiling to allow the sound to come from over your head by using a special upward-pointing speaker that is placed on the floor.

You can enjoy the Dolby Atmos 3D sound even in an environment where speakers cannot be installed on the ceiling.

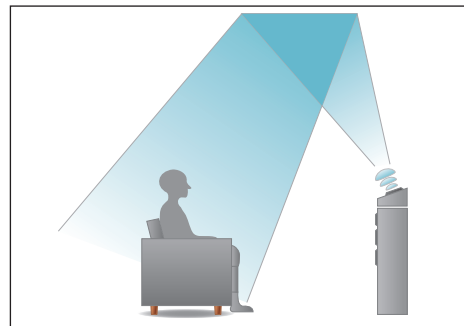



- This unit is compatible with Dolby Atmos and DTS:X which offers an even wider and deeper surround sensation.
- The “Speaker Virtualizer” must be set to “On” for Dolby Atmos playback with 5.1-channel speaker configurations or less. (p. 173)
- IMAX DTS:X / DTS:X can be selected regardless of the speaker configuration.
- Auro-3D recommends adding FRONT HEIGHT and SURROUND HEIGHT speakers to a 5.1 speaker configuration. Optionally, you may substitute REAR HEIGHT, Dolby Atmos Enabled speakers instead of FRONT HEIGHT and SURROUND HEIGHT speakers for Dolby Atmos, DTS:X and Auro-3D playback.

■ Recommended placement of the speakers

Floor speakers Layout

- Use the following illustration as a guide for the installation location of each floor speaker. You do not have to match them exactly.

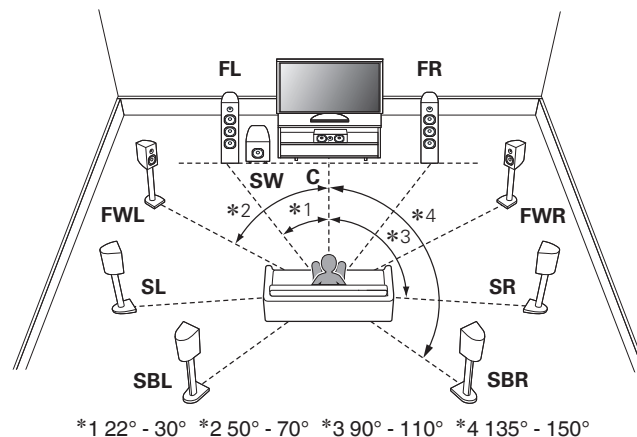

- If you are not using the surround back speakers, the recommended angle of the surround sound speakers (*3) is 120°.
- When using a single surround back speaker, place it directly behind the listening position.



Height speakers Layout

- Use the following illustration as a guide for the installation location of each height speaker. You do not have to match them exactly.

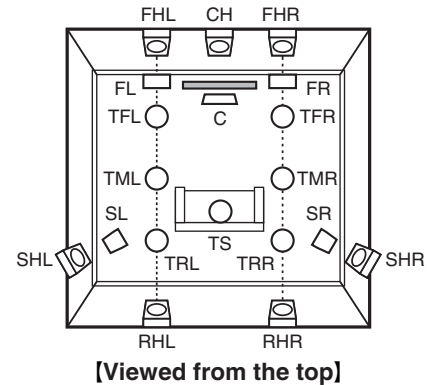
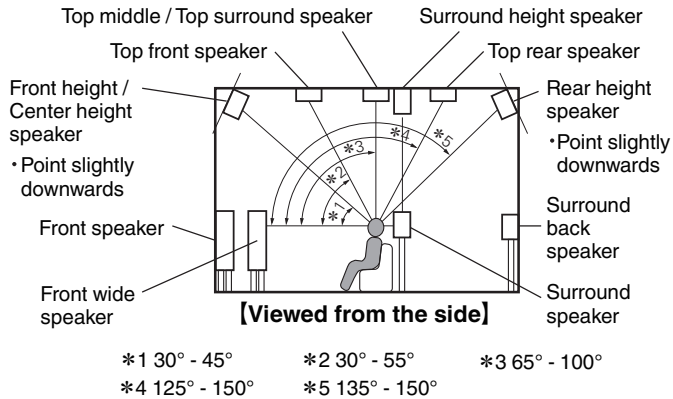

Connecting speakers

Here we connect the speakers in the room to this unit.

Before connecting speakers

NOTE

- Disconnect this unit's power plug from the power outlet before connecting the speakers. Also, turn off the subwoofer.
- Connect so that the speaker cable core wires do not protrude from the speaker terminal. The protection circuit may be activated if the core wires touch the rear panel or if the + and - sides touch each other. ("Protection circuit" (👉 p. 327))
- Never touch the speaker terminals while the power cord is connected. Doing so could result in electric shock. When the "Setup Assistant" (page 9 in the separate "Quick Start Guide") is running, follow the instructions in the "Setup Assistant" screen for making connections. (Power is not supplied to the speaker terminals while the "Setup Assistant" is running.)
- Use speakers with an impedance of 4 – 16 Ω /ohms.
- When connecting speakers with different impedances, set the impedance based on the speaker with the lowest impedance.

NOTE

- Carry out the following settings when using a speaker with an impedance of 4 – 6 Ω /ohms.

1. Press and hold the main unit's STATUS and ZONE3 SOURCE at the same time for at least 3 seconds.

"*Video Format <PAL>" appears on the display.

2. Press Cursor Down on the main unit three times.

"*Sp. Impedance <8ohms>" appears on the display.

3. Use Cursor Left or Cursor Right on the main unit to select the impedance.

8ohms (Default):	Select when the impedance for all of the connected speakers is 8 Ω /ohms or over.
----------------------------	------------------------------------------------------------------------------------------

6ohms:	Select when the impedance for any of the connected speakers is 6 Ω /ohms.
---------------	----------------------------------------------------------------------------------

4ohms:	Select when the impedance for any of the connected speakers is 4 Ω /ohms.
---------------	----------------------------------------------------------------------------------

4. Press the main unit's ENTER to complete the setting.



■ Connecting the speaker cables

Carefully check the left (L) and right (R) channels and + (red) and – (black) polarities on the speakers being connected to this unit, and be sure to connect the channels and polarities correctly.

- 1 Peel off about 10 mm of sheathing from the tip of the speaker cable, then either twist the core wire tightly or terminate it.



- 2 Turn the speaker terminal counterclockwise to loosen it.



- 3 Insert the speaker cable's core wire to the hilt into the speaker terminal.

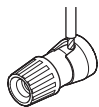

- 4 Turn the speaker terminal clockwise to tighten it.

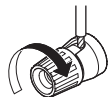

■ Connecting the subwoofer

Use a subwoofer cable to connect the subwoofer. Four subwoofers can be connected to this unit.

When you are connecting multiple subwoofers, change the setting of “Subwoofer” in the “Speaker Configuration” setting according to the number of subwoofers to be connected. (👉 p. 225)

The level and distance can be set separately for Subwoofer 1, Subwoofer 2, Subwoofer 3 and Subwoofer 4.

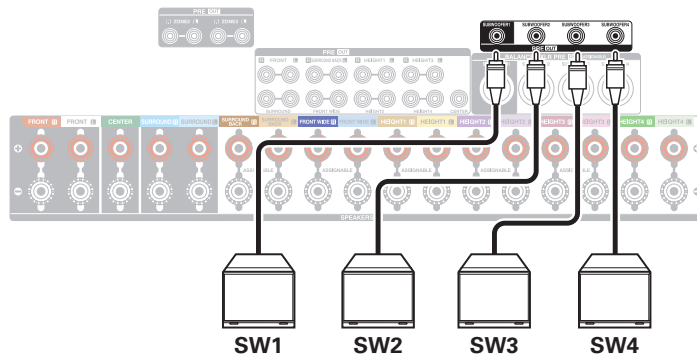

■ About the cable labels (supplied) for channel identification

The channel display section for speaker terminals on the rear panel is color-coded for each channel to be identifiable.

Attach the cable label corresponding to each speaker to each speaker cable.

This makes it easy to connect the correct cable to the speaker terminals on the rear panel.

Speaker	Color
FRONT L	White
FRONT R	Red
CENTER	Green
SURROUND L	Light Blue
SURROUND R	Blue
SURROUND BACK L	Beige
SURROUND BACK R	Brown
FRONT WIDE L	Mauve
FRONT WIDE R	Bright Navy
FRONT HEIGHT L	Light Yellow
FRONT HEIGHT R	Yellow
TOP FRONT L	Light Yellow
TOP FRONT R	Yellow
TOP MIDDLE L	Pink
TOP MIDDLE R	Magenta
TOP REAR L	Light Purple
TOP REAR R	Purple

Speaker	Color
SURROUND HEIGHT L	Pink
SURROUND HEIGHT R	Magenta
REAR HEIGHT L	Light Purple
REAR HEIGHT R	Purple
TOP SURROUND	Glass Green
CENTER HEIGHT	Olive Green
FRONT DOLBY L	Light Yellow
FRONT DOLBY R	Yellow
SURROUND DOLBY L	Pink
SURROUND DOLBY R	Magenta
BACK DOLBY L	Light Purple
BACK DOLBY R	Purple
SUBWOOFER 1	Black
SUBWOOFER 2	Black
SUBWOOFER 3	Black
SUBWOOFER 4	Black



The supplied cable labels include labels for the speaker and HDMI cables. Attach a cable label to each cable that matches the speakers and HDMI devices being connected, as shown below. This makes it easy to identify and properly connect the cables between your components.

[How to attach the cable labels]

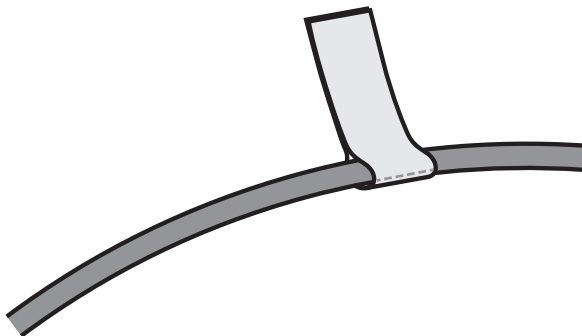

Connecting speakers to the speaker terminals

You can connect 17.4 channel speakers to this unit.

Connect each speaker according to the speakers you are using.

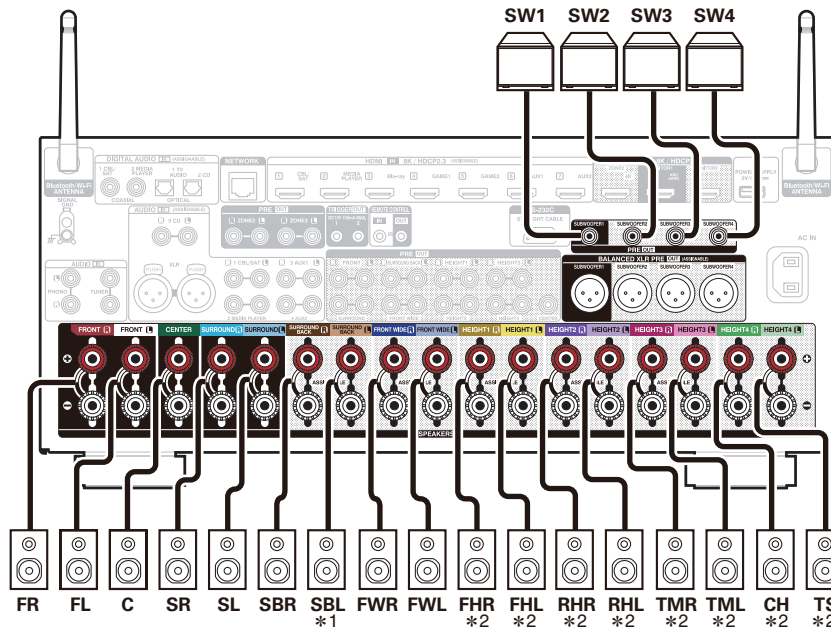

- *1 When using a single surround back speaker, connect it to the SURROUND BACK L terminal.
- *2 The output terminals for Height/Ceiling/Dolby Atmos Enabled speakers vary according to the speaker combination that you use. For the speaker terminal that connects each Height/Ceiling/Dolby Atmos Enabled speaker, refer to "Amp Assign" - "Layout" (p. 217).



Connecting an external power amplifier

You can use this unit as a preamplifier by connecting an external power amplifier to the PRE OUT connectors. By adding a power amplifier to each channel, the realism of the sound can be further enhanced. Select the terminal to use and connect the device.

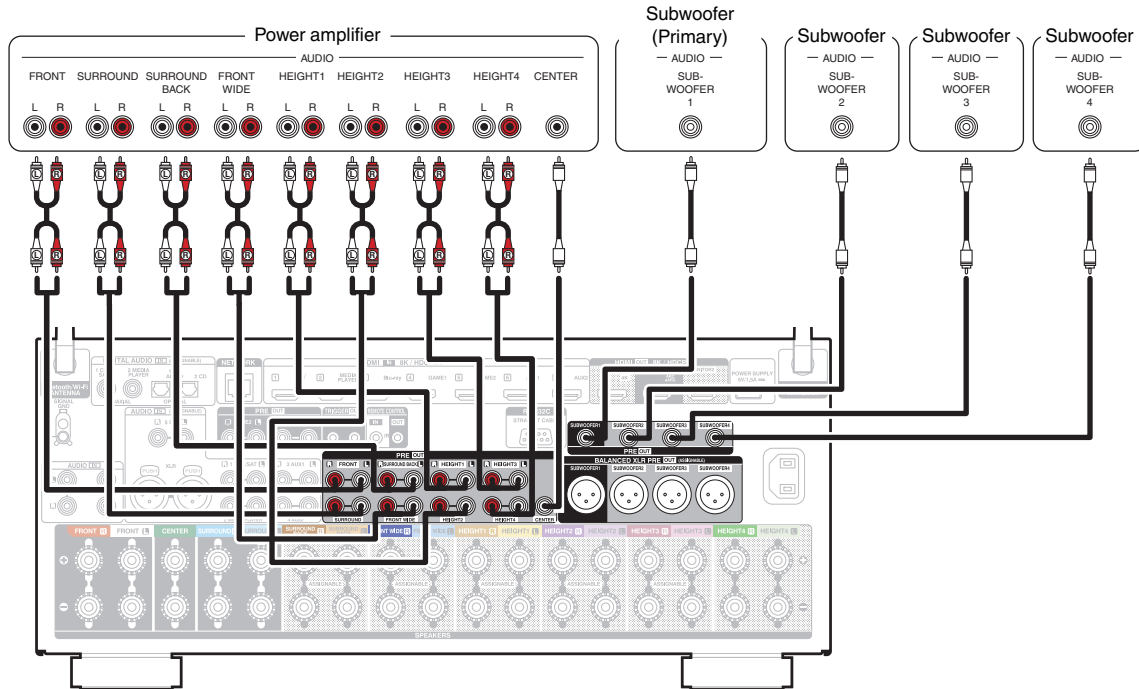



- Set "Assign Mode" to "Preamplifier" if connecting all channels to the Pre-out connectors using an external amplifier. (🔍 p. 215)
This stops operation of the internal power amplifier of this unit, reducing interference in the preamplifier created by the power amplifier.
- You can use the "Speaker Connection" setting to disconnect the built-in power circuit of each channel individually and use just your favorite channel as the Preamplifier. (🔍 p. 242)
- When using just one surround back speaker, connect it to the left channel (L) terminal.
- The output signal for the PRE OUT connector of Height 1, Height 2, Height 3, and Height 4 vary depending on the combination of the Height/Ceiling/Dolby Atmos Enabled speakers that you are using. For the PRE OUT connector that connects each Height/Ceiling/Dolby Atmos Enabled speaker, refer to "Amp Assign" - "Layout" (🔍 p. 217).
- You can connect to the subwoofer with either an RCA connection or the XLR terminal.
- The XLR terminal of the subwoofer can be used as a speaker other than a subwoofer such as the Front Left, Front Right, or Center channel. To use it as a speaker, assign it to a channel of your choice in "XLR Output Assign". (🔍 p. 237)

[AVC-A1H BALANCED XLR PRE OUT connector PIN arrangement]



- ① GND (Ground)
- ② HOT (+)
- ③ COLD (-)

The PIN arrangement in this unit uses the European method.

In the USA method, ② is COLD, and ③ is HOT.

When connecting a device that utilizes the USA type of PIN arrangement, replace the ② and ③ plugs on one side of the balanced cable.

NOTE

- Do not short the HOT and GND or COLD and GND for use.
- Disconnect this unit's power plug from the power outlet before connecting the speakers.
Also, turn off the power amp and subwoofer.



Speaker configuration and “Amp Assign” settings

This unit has a built-in 15-channel power amplifier. In addition to the basic 5.1-channel system, a variety of speaker systems can be configured by changing the “Amp Assign” settings to suit the application, such as 7.1-channel systems, bi-amp connections and 2-channel systems for multi-zone playback. (🔍 p. 213)

Perform “Amp Assign” settings to suit the number of rooms and speaker configuration to be installed. (🔍 p. 213)

Playback speaker in each zone			“Amp Assign” settings	Connection page	
MAIN ZONE	ZONE2	ZONE3			
5.1-channel playback	2-channel (Pre-out)	2-channel (Pre-out)	Can be set in all “Amp Assign” modes.	47	
7.1-channel playback				48	
9.1-channel playback				13.1ch + ZONE2	50
11.1-channel playback				13.1ch + ZONE2	53
13.1-channel playback (Dolby Atmos and Auro-3D)				15.1ch (Default)	59
15.1-channel playback for Dolby Atmos				15.1ch (Default)	59
15.1-channel for Dolby Atmos and 13.1ch for Auro-3D				15.1ch (Default)	60
13.1-channel playback (bi-amp connection of front speakers)				13.1ch (Bi-Amp)	61
7.1-channel playback (bi-amp connection of all channels)				7.1ch Full Bi-Amp	62
Second front speakers				13.1ch + Front B	64
13.1-channel playback	2-channel (Speaker out)	2-channel (Pre-out)	13.1ch + ZONE2	65	
13.1-channel playback	2-channel (Pre-out)	2-channel (Speaker out)	13.1ch + ZONE3	65	



Playback speaker in each zone			“Amp Assign” settings	Connection page
MAIN ZONE	ZONE2	ZONE3		
11.1-channel playback (bi-amp connection of front speakers)	2-channel (Speaker out)	2-channel (Pre-out)	11.1ch (Bi-Amp) + ZONE2	66
11.1-channel playback	2-channel (Speaker out)	2-channel (Speaker out)	11.1ch + ZONE2/3	67
13.1-channel playback	1-channel (Speaker out)	1-channel (Speaker out)	13.1ch + ZONE2/3-MONO	68
15.1-channel playback (using this unit as a preamplifier)	2-channel (Pre-out)	2-channel (Pre-out)	Preamplifier	43

The sound mode that can be selected varies according to the speaker configuration. The following pages provide basic connection examples.

Refer to the example connection for “Example layout for Auro-3D 11.1 channel system” (🔗 p. 55) when playing Auro-3D with a 11.1-channel system using the basic 5.1-channel system and the front height, surround height, Top Surround and Center Height speakers. Also refer to the connection example for “Example layout for Auro-3D 13.1 channel system” (🔗 p. 58) when playing Auro-3D with a 13.1-channel system by adding the surround back, top surround and center height speakers.



- In addition to the connections described in p. 47 - 68, this unit allows for various speaker connections with the “Amp Assign” setting. Also refer to the menu screen in “View Terminal Config.” on the “Amp Assign” setting screen, which shows how to make connections in your environment.

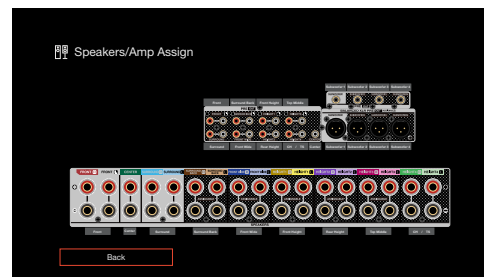

Connecting 5.1-channel speakers

This serves as a basic 5.1-channel surround system.

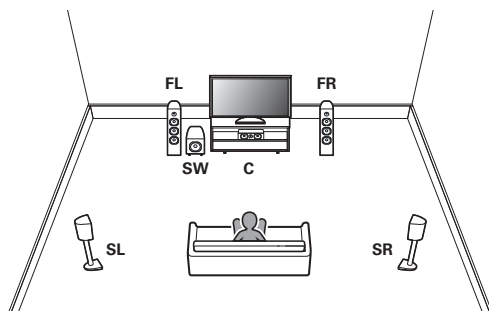

For each speaker connection, refer to “Connecting speakers to the speaker terminals” (👉 p. 42) or “Connecting an external power amplifier” (👉 p. 43).

Connecting 7.1-channel speakers

■ Example layout when using surround back speakers

This 7.1-channel surround system is basic 7.1-channel system.
(Adding surround back speakers to basic 5.1-channel system)

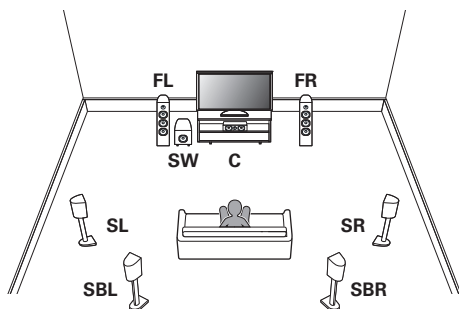

For each speaker connection, refer to the following.

- “Connecting speakers to the speaker terminals” (👉 p. 42)
- “Connecting an external power amplifier” (👉 p. 43)



- Set “Floor” - “Layout” to “5ch & SB” in the menu when connecting in this configuration. (👉 p. 215)

■ Example layout when using front wide speakers

This 7.1-channel surround system is the same as a basic 5.1-channel system but with front wide speakers.

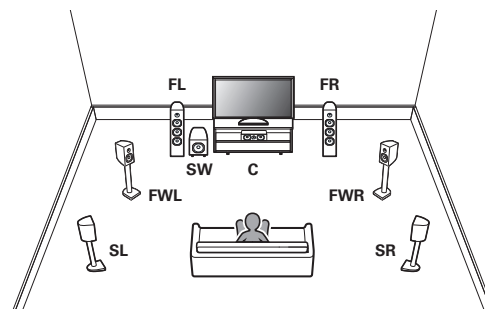

For each speaker connection, refer to the following.

- “Connecting speakers to the speaker terminals” (👉 p. 42)
- “Connecting an external power amplifier” (👉 p. 43)



- Set “Floor” - “Layout” to “5ch & FW” in the menu when connecting in this configuration. (👉 p. 215)



■ Example layout when using height speakers

This 7.1-channel surround system is the same as a basic 5.1-channel system but with front height speakers.

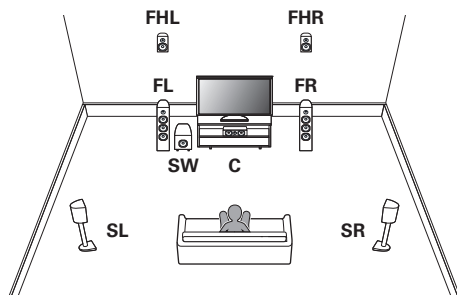

For each speaker connection, refer to the following.

- “Connecting speakers to the speaker terminals” (🔗 p. 42)
- “Connecting an external power amplifier” (🔗 p. 43)



- Set “Floor” - “Layout” to “5ch” and “Height Sp” (or “Dolby Sp”) to “2ch” in the menu when connecting in this configuration. (🔗 p. 215)
- You can change the Front Height Speakers to any Height/Ceiling/Dolby Atmos Enabled speakers in the “Amp Assign” - “Layout” setting. (🔗 p. 217)



Connecting 9.1-channel speakers

■ Example layout when using surround back and front wide speakers

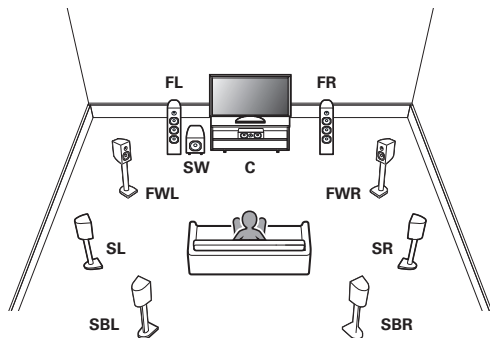

For each speaker connection, refer to the following.

- “Connecting speakers to the speaker terminals” (👉 p. 42)
- “Connecting an external power amplifier” (👉 p. 43)



- Set “Floor” - “Layout” to “5ch & SB & FW” in the menu when connecting in this configuration. (👉 p. 215)

■ Example layout when using surround back and one set of height speakers

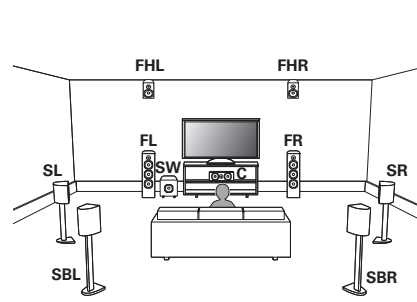

For each speaker connection, refer to the following.

- “Connecting speakers to the speaker terminals” (👉 p. 42)
- “Connecting an external power amplifier” (👉 p. 43)



- Set “Floor” - “Layout” to “5ch & SB” and “Height Sp” (or “Dolby Sp”) to “2ch” in the menu when connecting in this configuration. (👉 p. 215)
- You can change the Front Height Speakers to any Height/Ceiling/Dolby Atmos Enabled speakers in the “Amp Assign” - “Layout” setting. (👉 p. 217)



■ Example layout when using front wide and one set of height speakers

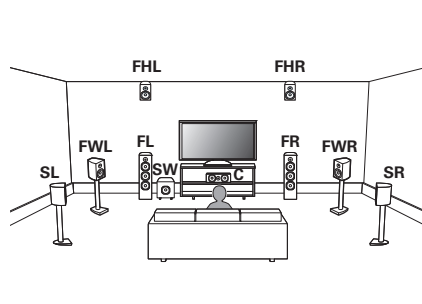

For each speaker connection, refer to the following.

- “Connecting speakers to the speaker terminals” (🔗 p. 42)
- “Connecting an external power amplifier” (🔗 p. 43)



- Set “Floor” - “Layout” to “5ch & FW” and “Height Sp” (or “Dolby Sp”) to “2ch” in the menu when connecting in this configuration. (🔗 p. 215)
- You can change the Front Height Speakers to any Height/Ceiling/Dolby Atmos Enabled speakers in the “Amp Assign” - “Layout” setting. (🔗 p. 217)

■ Example layout when using two sets of height speakers

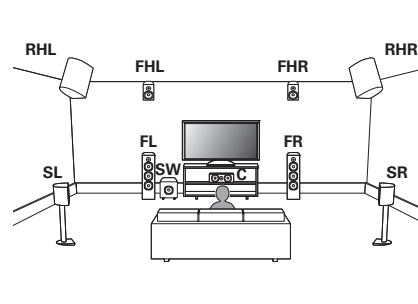

For each speaker connection, refer to the following.

- “Connecting speakers to the speaker terminals” (🔗 p. 42)
- “Connecting an external power amplifier” (🔗 p. 43)



- Set “Floor” - “Layout” to “5ch” and “Height Sp” (or “Dolby Sp”) to “4ch” in the menu when connecting in this configuration. (🔗 p. 215)
- You can change the Front Height Speakers and Rear Height Speakers to any Height/Ceiling/Dolby Atmos Enabled speakers in the “Amp Assign” - “Layout” setting. (🔗 p. 218)



■ Example layout for Auro-3D 9.1 channel system

This speaker configuration is optimized for Auro-3D playback.

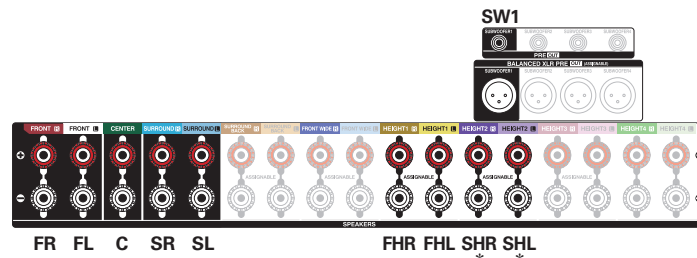
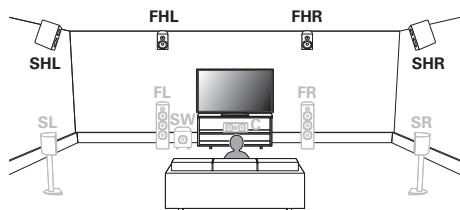

* For the best Auro-3D experience Surround Height speakers are recommended, however you may substitute Rear Height speakers from a Dolby Atmos speaker setup in place of Surround Height speakers.



- Set “Floor” to “5ch” and “Height Sp” to “4ch” in the menu when connecting in this configuration. (🔗 p. 215)
Next, set “Height” - “Front Layout” to “Front Height” and “Rear Layout” to “Surround Height”. (🔗 p. 219)



Connecting 11.1-channel speakers

■ Example layout when using surround back, Front Wide and one set of height speakers

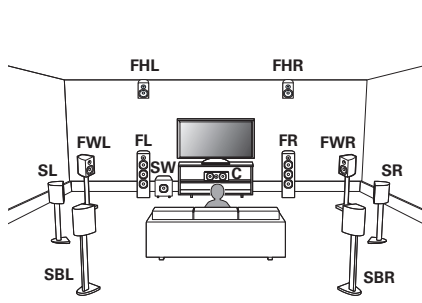

For each speaker connection, refer to the following.

- “Connecting speakers to the speaker terminals” (🔗 p. 42)
- “Connecting an external power amplifier” (🔗 p. 43)



- Set “Floor” - “Layout” to “5ch & SB & FW” and “Height Sp” (or “Dolby Sp”) to “2ch” in the menu when connecting in this configuration. (🔗 p. 215)
- You can change the Front Height Speakers to any Height/Ceiling/Dolby Atmos Enabled speakers in the “Amp Assign” - “Layout” setting. (🔗 p. 217)

■ Example layout when using surround back and two sets of height speakers

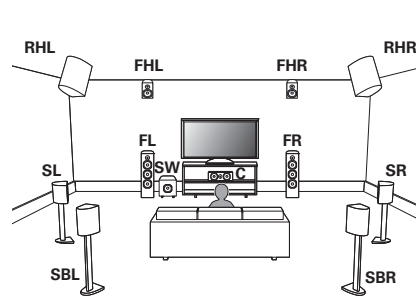

For each speaker connection, refer to the following.

- “Connecting speakers to the speaker terminals” (🔗 p. 42)
- “Connecting an external power amplifier” (🔗 p. 43)



- Set “Floor” - “Layout” to “5ch & SB” and “Height Sp” (or “Dolby Sp”) to “4ch” in the menu when connecting in this configuration. (🔗 p. 215)
- You can change the Front Height Speakers and Rear Height Speakers to any Height/Ceiling/Dolby Atmos Enabled speakers in the “Amp Assign” - “Layout” setting. (🔗 p. 218)



■ Example layout when using front wide and two sets of height speakers

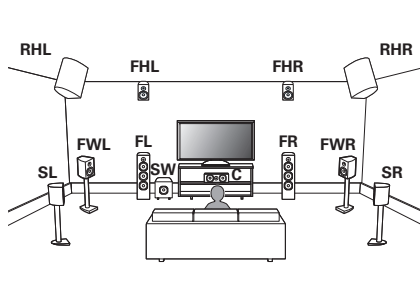

For each speaker connection, refer to the following.

- “Connecting speakers to the speaker terminals” (🔗 p. 42)
- “Connecting an external power amplifier” (🔗 p. 43)



- Set “Floor” - “Layout” to “5ch & FW” and “Height Sp” (or “Dolby Sp”) to “4ch” in the menu when connecting in this configuration. (🔗 p. 215)
- You can change the Front Height Speakers and Rear Height Speakers to any Height/Ceiling/Dolby Atmos Enabled speakers in the “Amp Assign” - “Layout” setting. (🔗 p. 218)

■ Example layout when using three sets of height speakers

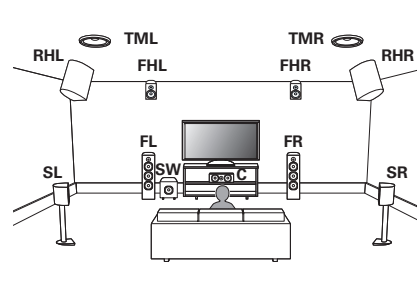

For each speaker connection, refer to the following.

- “Connecting speakers to the speaker terminals” (🔗 p. 42)
- “Connecting an external power amplifier” (🔗 p. 43)



- Set “Floor” - “Layout” to “5ch” and “Height Sp” (or “Dolby Sp”) to “6ch” in the menu when connecting in this configuration. (🔗 p. 215)
- You can change the Front Height Speakers, Top Middle Speakers and Rear Height Speakers to any Height/Ceiling/Dolby Atmos Enabled speakers in the “Amp Assign” - “Layout” setting. (🔗 p. 220)



■ Example layout for Auro-3D 11.1 channel system

This speaker configuration is optimized for Auro-3D playback.

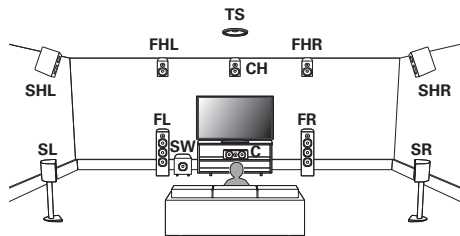

For each speaker connection, refer to the following.

- “Connecting speakers to the speaker terminals” (🔧 p. 42)
- “Connecting an external power amplifier” (🔧 p. 43)



- Set “Floor” - “Layout” to “5ch” and “Height Sp” to “6ch” in the menu when connecting in this configuration. (🔧 p. 215)
Next, set “Height” - “Front Layout” to “Front Height & Center Height” and “Middle Layout” to “Surround Height & Top Surround”. (🔧 p. 218)

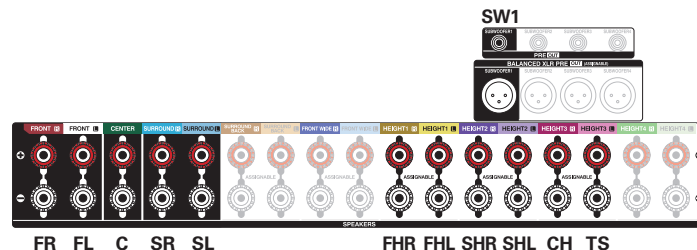

- To use two sets of height speakers with a center height and top surround speakers, connect the center height and top surround speakers to the HEIGHT 3 connector.
- For the best Auro-3D experience Surround Height speakers are recommended, however you may substitute Rear Height speakers from a Dolby Atmos speaker setup in place of Surround Height speakers.



Connecting 13.1-channel speakers

■ Example layout when using surround back, Front Wide and two set of height speakers

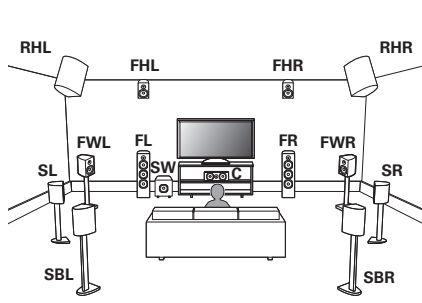

For each speaker connection, refer to the following.

- “Connecting speakers to the speaker terminals” (🔗 p. 42)
- “Connecting an external power amplifier” (🔗 p. 43)



- Set “Floor” - “Layout” to “5ch & SB & FW” and “Height Sp” (or “Dolby Sp”) to “4ch” in the menu when connecting in this configuration. (🔗 p. 215)
- You can change the Front Height Speakers and Rear Height Speakers to any Height/Ceiling/Dolby Atmos Enabled speakers in the “Amp Assign” - “Layout” setting. (🔗 p. 218)

■ Example layout when using surround back and three sets of height speakers

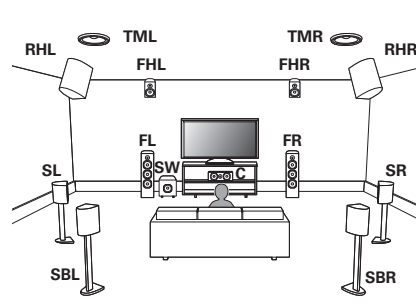

For each speaker connection, refer to the following.

- “Connecting speakers to the speaker terminals” (🔗 p. 42)
- “Connecting an external power amplifier” (🔗 p. 43)



- Set “Floor” - “Layout” to “5ch & SB” and “Height Sp” (or “Dolby Sp”) to “6ch” in the menu when connecting in this configuration. (🔗 p. 215)
- You can change the Front Height Speakers, Top Middle Speakers and Rear Height Speakers to any Height/Ceiling/Dolby Atmos Enabled speakers in the “Amp Assign” - “Layout” setting. (🔗 p. 220)



■ Example layout when using front wide and three sets of height speakers

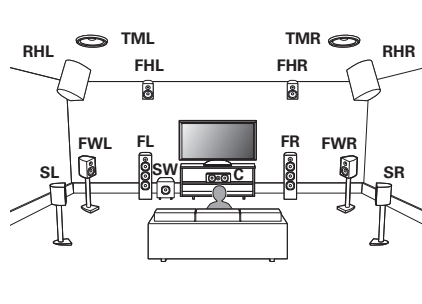

For each speaker connection, refer to the following.

- “Connecting speakers to the speaker terminals” (🔗 p. 42)
- “Connecting an external power amplifier” (🔗 p. 43)



- Set “Floor” - “Layout” to “5ch & FW” and “Height Sp” (or “Dolby Sp”) to “6ch” in the menu when connecting in this configuration. (🔗 p. 215)
- You can change the Front Height Speakers, Top Middle Speakers and Rear Height Speakers to any Height/Ceiling/Dolby Atmos Enabled speakers in the “Amp Assign” - “Layout” setting. (🔗 p. 220)



Example layout for Auro-3D 13.1 channel system

This speaker configuration is optimized for Auro-3D playback.

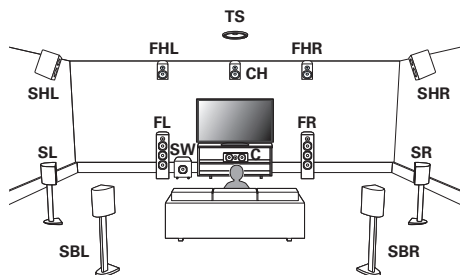

For each speaker connection, refer to the following.

- “Connecting speakers to the speaker terminals” (🔗 p. 42)
- “Connecting an external power amplifier” (🔗 p. 43)



- Set “Floor” - “Layout” to “5ch & SB” and “Height Sp” to “6ch” in the menu when connecting in this configuration. (🔗 p. 215)
Next, set “Height” - “Front Layout” to “Front Height & Center Height” and “Middle Layout” to “Surround Height & Top Surround”. (🔗 p. 220)

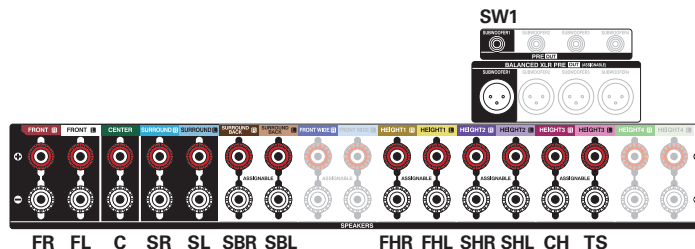

- To use two sets of height speakers with a center height and top surround speakers, connect the center height and top surround speakers to the HEIGHT 3 connector.
- For the best Auro-3D experience Surround Height speakers are recommended, however you may substitute Rear Height speakers from a Dolby Atmos speaker setup in place of Surround Height speakers.



Connecting 15.1-channel speakers

■ Example layout when using surround back, Front Wide and three set of height speakers

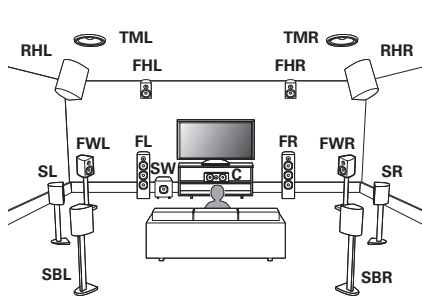

For each speaker connection, refer to the following.

- “Connecting speakers to the speaker terminals” (👉 p. 42)
- “Connecting an external power amplifier” (👉 p. 43)



- Set “Floor” - “Layout” to “5ch & SB & FW” and “Height Sp” (or “Dolby Sp”) to “6ch” in the menu when connecting in this configuration. (👉 p. 215)
- You can change the Front Height Speakers, Top Middle Speakers and Rear Height Speakers to any Height/Ceiling/Dolby Atmos Enabled speakers in the “Amp Assign” - “Layout” setting. (👉 p. 220)

■ Example layout when using surround back and eight height speakers

This system can connect with up to 15.1-channel speakers and simultaneously play up to 13.1-channels for Dolby Atmos and Auro-3D playback.

The top middle speakers, top surround speaker, and center height speaker are switched and played according to the audio format you are playing.

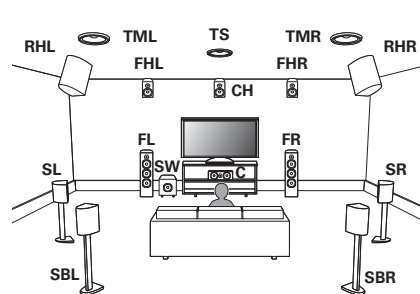

For each speaker connection, refer to the following.

- “Connecting speakers to the speaker terminals” (👉 p. 42)
- “Connecting an external power amplifier” (👉 p. 43)



- Set “Floor” - “Layout” to “5ch & SB” and “Height Sp” to “8ch” in the menu when connecting in this configuration. (👉 p. 215)



Connecting 17.1-channel speakers

This system can connect with up to 17.1-channel speakers and simultaneously play up to 15.1-channels for Dolby Atmos and play up to 13.1-channel for Auro-3D playback.

The top middle speakers, top surround speaker, and center height speaker are switched and played according to the audio format you are playing.

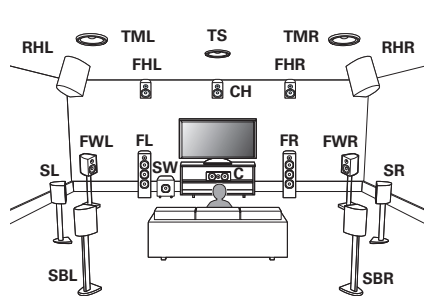

For each speaker connection, refer to the following.

- “Connecting speakers to the speaker terminals” (🔗 p. 42)
- “Connecting an external power amplifier” (🔗 p. 43)



- Set “Floor” - “Layout” to “5ch & SB & FW” and “Height Sp” to “8ch” in the menu when connecting in this configuration. (🔗 p. 215)
- You can change the Front Height Speakers, Top Middle Speakers and Rear Height Speakers to any Height/Ceiling/Dolby Atmos Enabled speakers in the “Amp Assign” - “Layout” setting. (🔗 p. 222)



Bi-amp connection

■ 13.1-channel playback (bi-amp connection of front speakers)

This system plays back 13.1-channels. You can use the bi-amp connection for front speakers. Bi-amp connection is a method to connect separate amplifiers to the tweeter terminal and woofer terminal of a speaker that supports bi-amplification. This connection enables back EMF (power returned without being output) from the woofer to flow into the tweeter without affecting the sound quality, producing a higher sound quality.

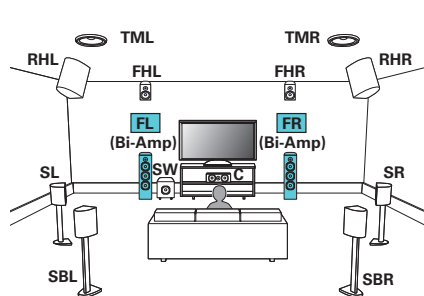

NOTE

- When making bi-amp connections, be sure to remove the short-circuiting plate or wire between the speaker's woofer and tweeter terminals.

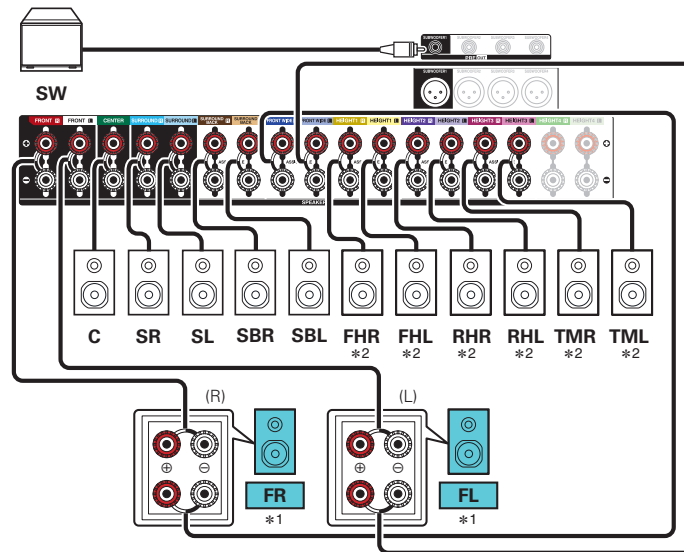

- *1 The speaker terminals for bi-amp connections to the front speakers vary depending on the MAIN ZONE layout. Refer to "Amp Assign" - "Bi-Amp". (☞ p. 223)
- *2 The height speakers, ceiling speakers and Dolby Atmos Enabled speakers can be connected to the HEIGHT1, HEIGHT2 and HEIGHT3 speaker terminals. Set the speaker to be connected from "Height" in the menu. (☞ p. 217)



■ 7.1-channel playback : Bi-amp connection of all speakers

This system plays back 7.1-channels.

Bi-amp connections are available for all the speakers.

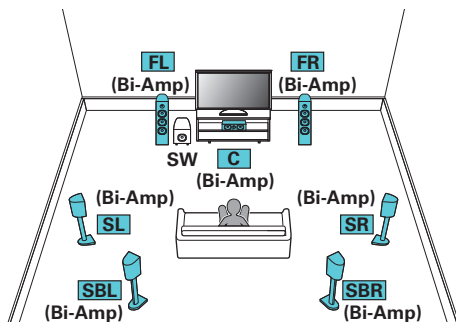

- In addition to the 7.1ch system with surround back speakers, you can make it into a 7.1ch system that uses front wide or height speakers. To configure this, set "Amp Assign" - "Assign Mode" to "7.1ch Full Bi-Amp", and then set "Floor" and "Height" according to the speakers you are using. (👉 p. 214)
- For the "7.1ch Full Bi-Amp" setting, the connection terminals vary according to the speaker layout you are using. Connect them by referencing the following table.



■ Output audio signal from each Speaker Terminal

Refer to the following table, use the Speaker terminals that output the same signal and make a bi-amp connection.

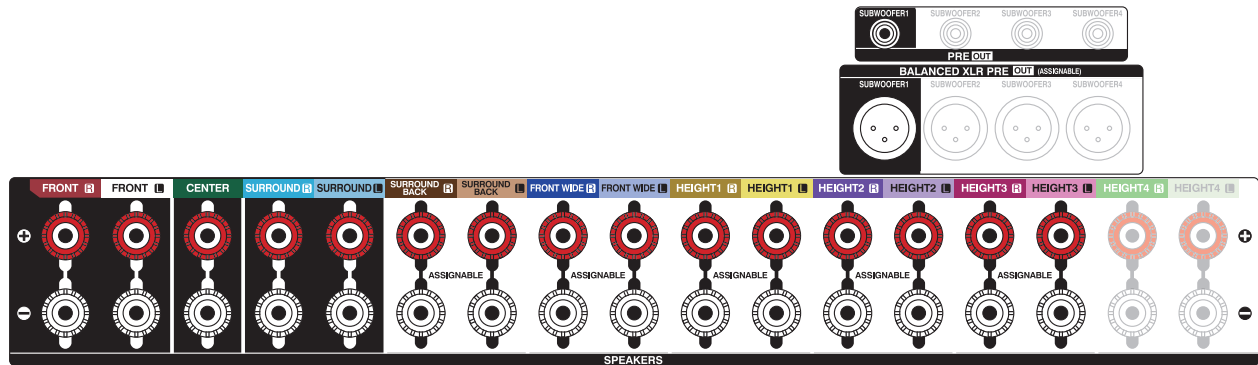

Speaker layout	Speaker terminal																
	FRONT R	FRONT L	CENTER	SURROUND R	SURROUND L	SURROUND BACK R	SURROUND BACK L	FRONT WIDE R	FRONT WIDE L	HEIGHT 1 R	HEIGHT 1 L	HEIGHT 2 R	HEIGHT 2 L	HEIGHT 3 R	HEIGHT 3 L	HEIGHT 4 R	HEIGHT 4 L
5.1ch + Surround Back	Front R	Front L	Center	Surround	Surround L	Surround Back R	Surround Back L	Front R	Front L	Not Used	Center	Surround R	Surround L	Surround Back R	Surround Back L	Not Used	Not Used
5.1ch + Front Wide	Front R	Front L	Center	Surround	Surround L	Front Wide R	Front Wide L	Front Wide R	Front Wide L	Not Used	Center	Surround R	Surround L	Front R	Front L	Not Used	Not Used
5.1ch + Height	Front R	Front L	Center	Surround	Surround L	Height R	Height L	Front R	Front L	Height R	Height L	Surround R	Surround L	Not Used	Center	Not Used	Not Used



Connecting 13.1-channel speakers : Second pair of front speakers

This system enables switching playback between front speakers A and B as desired.

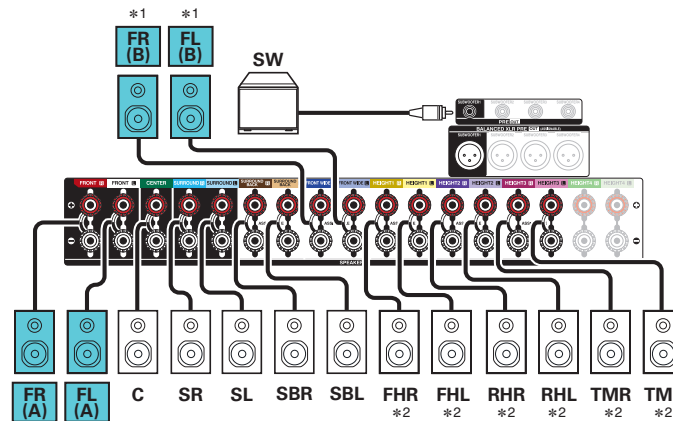
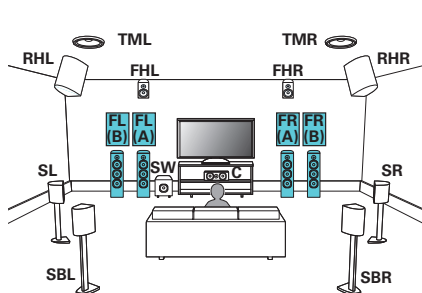

- *1 The speaker terminals for connecting to the second front speakers vary depending on the MAIN ZONE layout. Refer to "Amp Assign" - "Front B". (☞ p. 223)
- *2 The height speakers, ceiling speakers and Dolby Atmos Enabled speakers can be connected to the HEIGHT1, HEIGHT2 and HEIGHT3 speaker terminals. Set the speaker to be connected from "Height" in the menu. (☞ p. 217)



Connecting multi-zone speakers

■ 13.1-channel playback (MAIN ZONE) + 2-channel playback (ZONE2 or ZONE3)

This type of configuration plays back 13.1-channels in MAIN ZONE and 2-channels in ZONE2.
 (Speakers can output audio from ZONE3 instead of ZONE2 (Assign Mode: 13.1ch + ZONE3)).

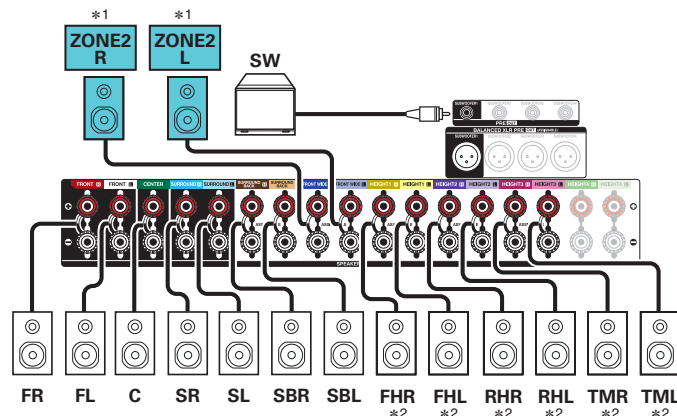
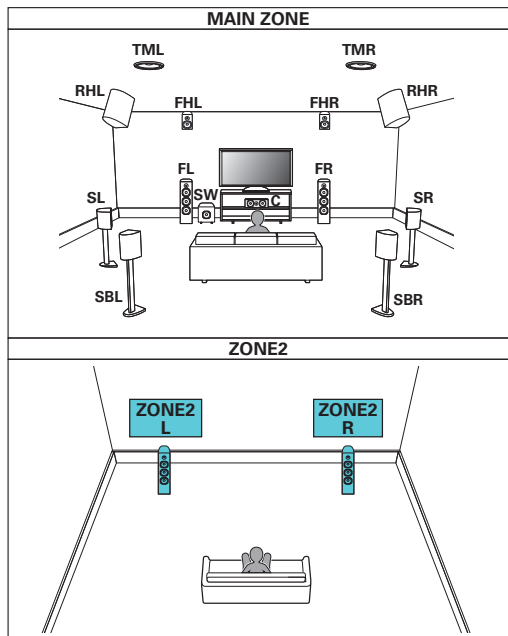

- *1 The speaker terminals for connecting to the ZONE2 (ZONE 3) speakers vary depending on the main zone layout. Refer to "Amp Assign" - "ZONE2" ("ZONE3"). (☞ p. 213)
- *2 The height speakers, ceiling speakers and Dolby Atmos Enabled speakers can be connected to the HEIGHT1, HEIGHT2 and HEIGHT3 speaker terminals. Set the speaker to be connected from "Height" in the menu. (☞ p. 217)



■ 11.1-channel playback (bi-amp connection of front speakers: MAIN ZONE) + 2-channel playback (ZONE2)

This type of configuration plays back 11.1-channels in MAIN ZONE and 2-channels in ZONE2. You can use the bi-amp connection for front speakers in MAIN ZONE.

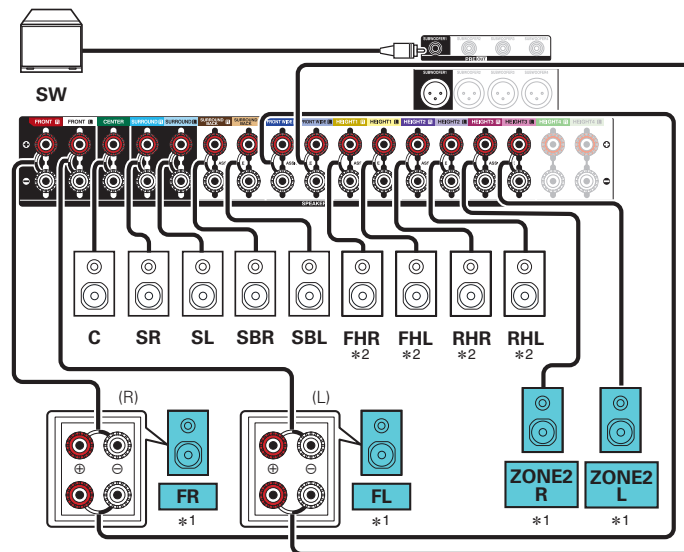
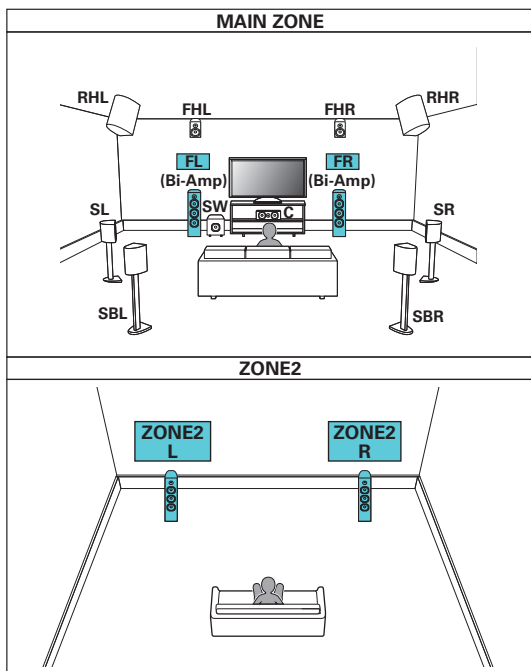

- *1 The terminals for bi-amp connections of the front speakers and the speaker terminals for the ZONE2 speakers vary depending on the MAIN ZONE layout. Refer to "Amp Assign" - "Bi-Amp" and "ZONE2". (☞ p. 213)
- *2 The height speakers, ceiling speakers and Dolby Atmos Enabled speakers can be connected to the HEIGHT1 and HEIGHT2 speaker terminals. Set the speaker to be connected from "Height" in the menu. (☞ p. 217)



■ 11.1-channel playback (MAIN ZONE) + 2-channel playback (ZONE2) + 2-channel playback (ZONE3)

This type of configuration plays back 11.1-channels in MAIN ZONE and 2-channels in ZONE2 and ZONE3.

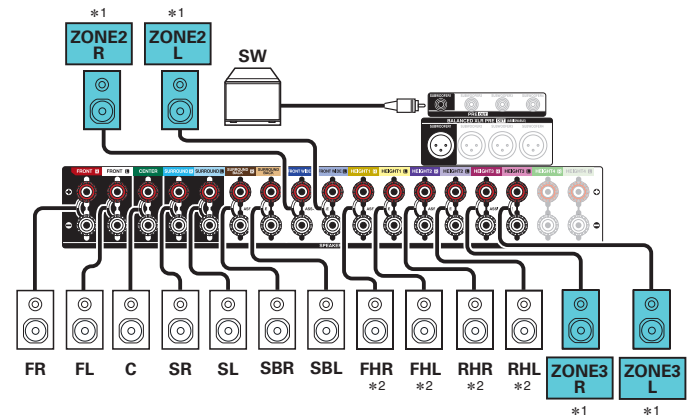
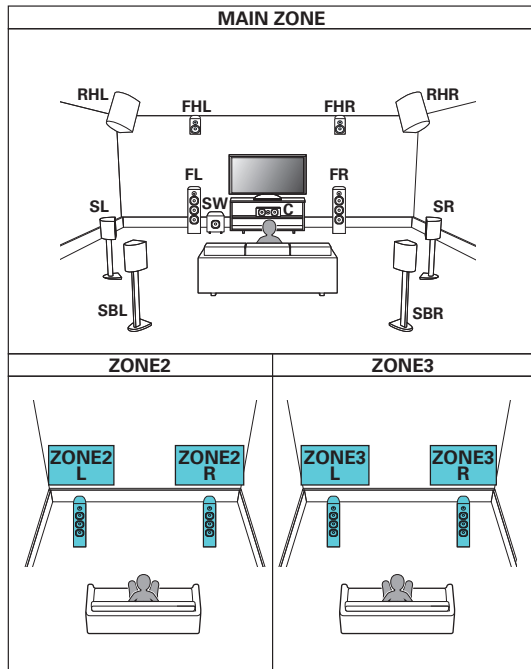

- *1 The speaker terminals for connecting to the ZONE2 speakers and ZONE3 speakers vary depending on the MAIN ZONE layout. Refer to “Amp Assign” - “ZONE2” and “ZONE3”. (p. 213)
- *2 The height speakers, ceiling speakers and Dolby Atmos Enabled speakers can be connected to the HEIGHT1 and HEIGHT2 speaker terminals. Set the speaker to be connected from “Height” in the menu. (p. 217)



■ 13.1-channel playback (MAIN ZONE) + 1-channel playback (ZONE2) + 1-channel playback (ZONE3)

This type of configuration plays back 13.1-channels in MAIN ZONE and 1-channel (monaural) in ZONE2 and ZONE3.

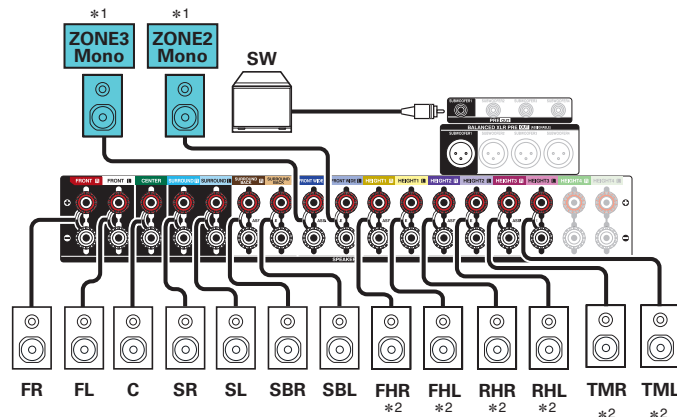
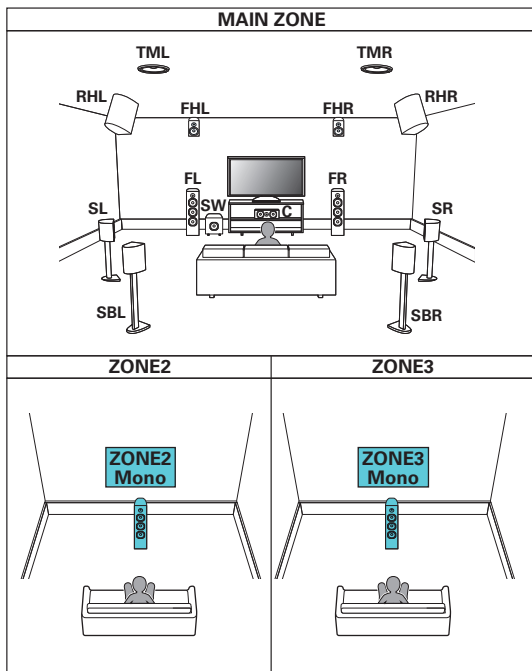

- *1 The speaker terminals for connecting to the ZONE2/3 speakers vary depending on the MAIN ZONE layout. Refer to "Amp Assign" - "ZONE2/3". (p. 213)
- *2 The height speakers, ceiling speakers and Dolby Atmos Enabled speakers can be connected to the HEIGHT1, HEIGHT2 and HEIGHT3 speaker terminals. Set the speaker to be connected from "Height" in the menu. (p. 217)



Connecting a TV

Connect a TV to this unit so that the input video is output to the TV. You can also enjoy audio from the TV on this unit.

How to connect a TV depends on the connectors and functions equipped on the TV.

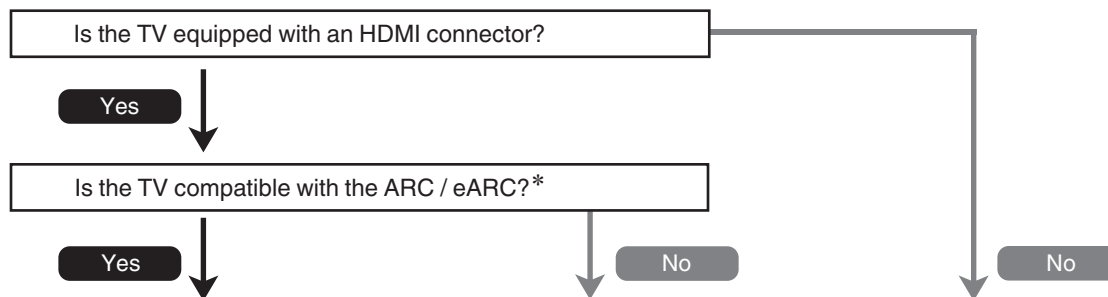

“Connection 1 : TV equipped with an HDMI connector and compatible with the ARC / eARC” (🔗 p. 70)

“Connection 2 : TV equipped with an HDMI connector and incompatible with the ARC / eARC” (🔗 p. 71)

You cannot connect the TV to this unit.

* What is ARC and eARC?

ARC (Audio Return Channel) sends audio back to this unit using the same HDMI cable that sends video from this unit to your TV.

This allows this unit to process the sound from your TV's built-in tuner and apps.

TVs with eARC (Enhanced Audio Return Channel) port provide additional support for high bitrate multichannel audio (Dolby Atmos, Dolby TrueHD, DTS-HD and DTS:X).

Please refer to your TV Owner's Manual for details about eARC support for your particular model.

NOTE

- Use a TV with a 2 prong power plug for this unit. Do not connect a TV with a 3 prong power plug, as this may cause noise.



Connection 1 : TV equipped with an HDMI connector and compatible with the ARC / eARC

Using a high quality HDMI cable*, connect one end to the HDMI port labeled “eARC” or “ARC” on your TV. Connect the other end to the HDMI OUT MONITOR 1 port on this unit.

When a TV with eARC support is connected, the eARC function of this unit is enabled automatically and the television audio is played back. When a TV with ARC support is connected, set “ARC” in the menu to “On”. (🔑 p. 188)

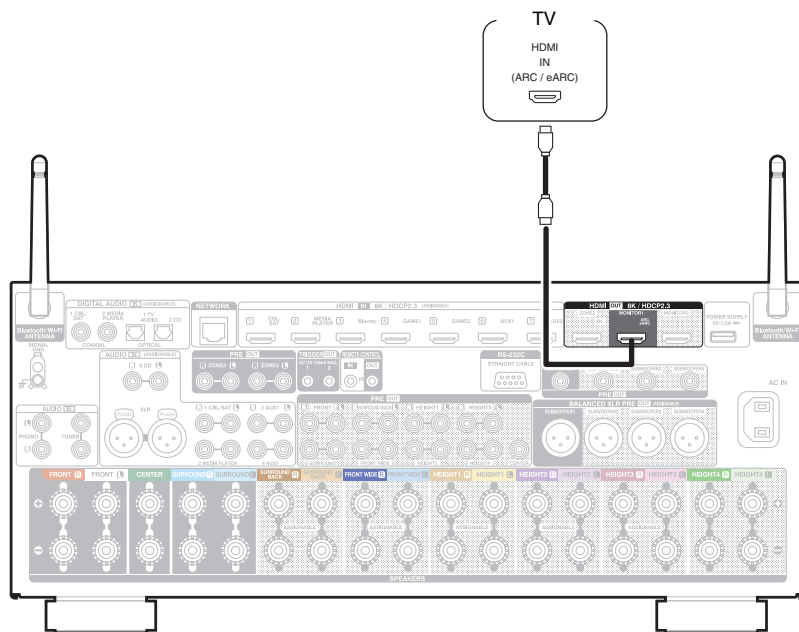

* For 4K TVs we recommend using an HDMI cable labeled “High Speed” and “with Ethernet”.

* For 8K TVs we recommend using an HDMI cable labeled “Ultra High Speed”.



- eARC function settings may be required depending on the eARC function-compatible television you are using. Make sure eARC is set to on if this setting exists on your television. For more information, check your television's owner's manual.
- Use a certified “Ultra High Speed HDMI cable” to enjoy 8K or 4K 120Hz video.
- Set “4K/8K Signal Format” to “8K Enhanced” in the menu to enjoy 8K video. (🔑 p. 194)



Connection 2 : TV equipped with an HDMI connector and incompatible with the ARC / eARC

Use an HDMI cable to connect the TV to this unit.

To listen to audio from TV on this unit, use an optical cable to connect the TV to this unit.

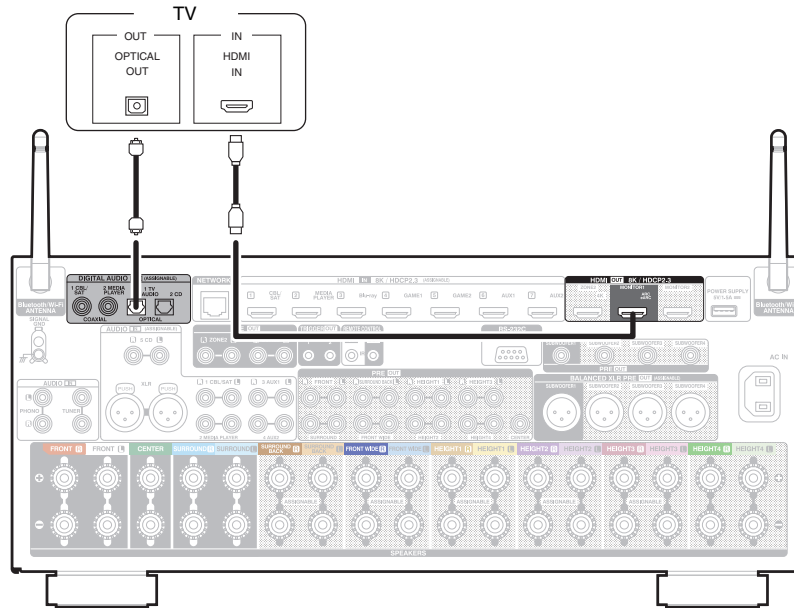

Connecting a playback device

This unit is equipped with HDMI video input connectors and three types of audio input connectors (HDMI, digital audio and audio).

Select input connectors on this unit according to the connectors equipped on the device you want to connect.

If the device connected to this unit is equipped with an HDMI connector, it is recommended to use HDMI connections.

In the HDMI connection, audio and video signals can be transmitted through a single HDMI cable.

- “Connecting a set-top box (Satellite tuner/cable TV)” (🔍 p. 73)
- “Connecting a media player” (🔍 p. 74)
- “Connecting a Blu-ray Disc player or DVD player” (🔍 p. 75)
- “Connecting a game console or player device compatible with 8K” (🔍 p. 76)
- “Connecting a turntable” (🔍 p. 77)



- Connect devices to this unit as indicated by the input sources printed on the audio/video input connectors of this unit.
- The source that is assigned to the HDMI IN, DIGITAL AUDIO IN and AUDIO IN connectors can be changed. See “Input Assign” on how to change the input source assigned to the input connectors. (🔍 p. 197)
- To play back audio signals that are input to this unit on a TV connected via HDMI, set in the menu “HDMI Audio Out” to “TV”. (🔍 p. 186)
- To enjoy content that is copyright protected by HDCP 2.2 or HDCP 2.3, use a playback device and TV compatible with HDCP 2.2 or HDCP 2.3.



Connecting a set-top box (Satellite tuner/cable TV)

This explanation uses the connection with a satellite tuner/cable TV STB as an example.

Select the input connectors on this unit to match the connectors on the device that you want to connect to.

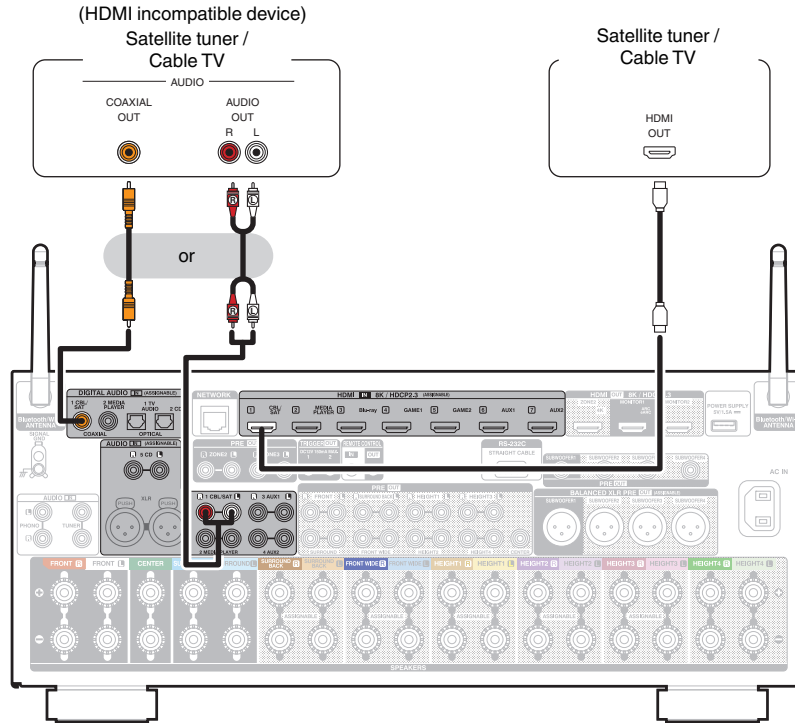

Connecting a media player

This explanation uses the connection with a media player as an example.

Select the input connectors on this unit to match the connectors on the device that you want to connect to.

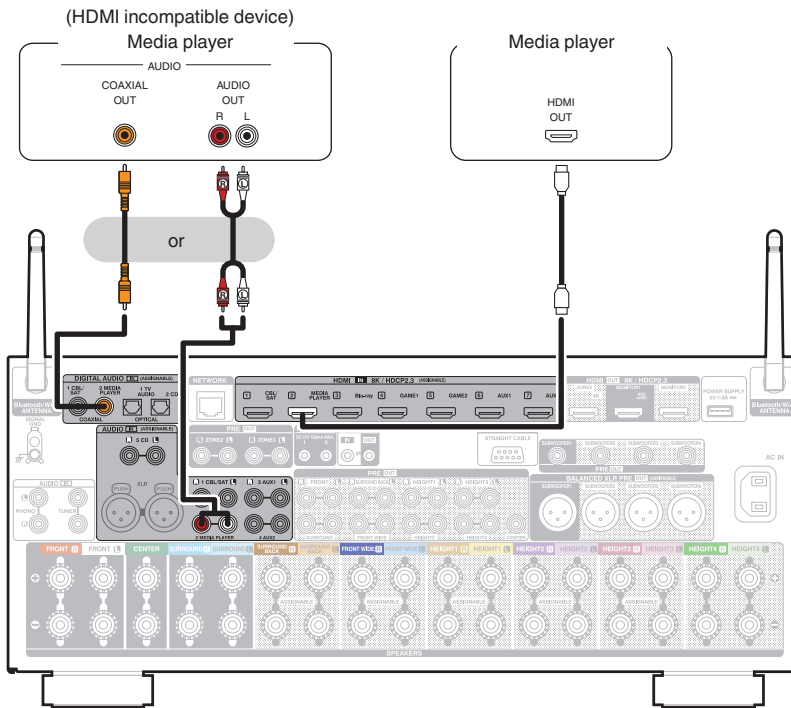

Connecting a Blu-ray Disc player or DVD player

This explanation uses the connection with a Blu-ray Disc player or DVD player as an example.
Select the input connectors on this unit to match the connectors on the device that you want to connect to.

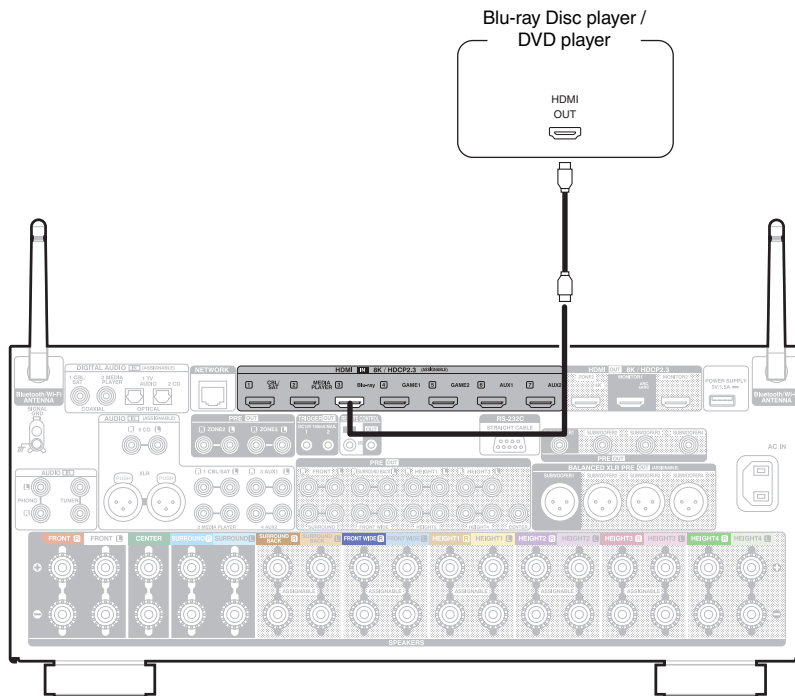

Connecting a game console or player device compatible with 8K

This unit supports 8K HDMI video signals.

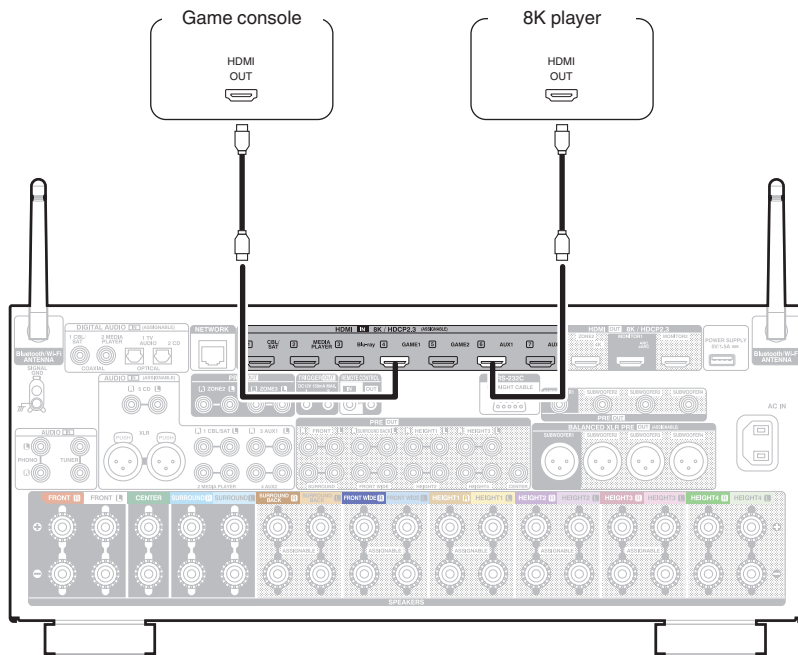

- Use a certified “Ultra High Speed HDMI cable” to enjoy 8K or 4K 120Hz video.
- Set “4K/8K Signal Format” to “8K Enhanced” in the menu to enjoy 8K video. (🔍 p. 194)



Connecting a turntable

This unit is compatible with turntables equipped with a moving magnet (MM) phono cartridge. When you connect to a turntable with a low output moving coil (MC) cartridge, use a commercially available MC head amp or a step-up transformer.

If you set this unit's input source to "Phono" and you accidentally increase the volume without having a turntable connected, you may hear a hum noise from the speakers.

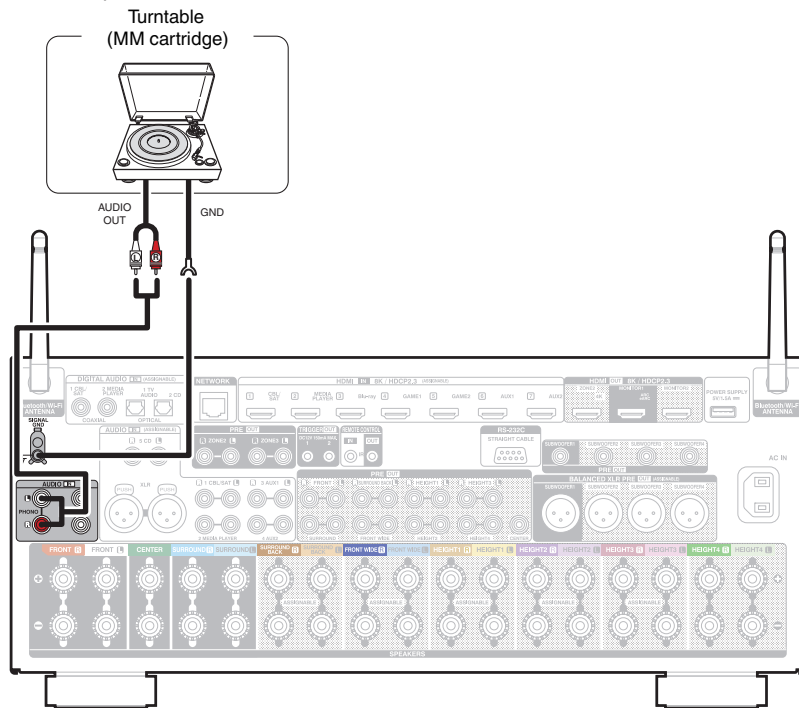

NOTE

- The earth terminal (SIGNAL GND) of this unit is not for safety grounding purposes. If this terminal is connected when there is a lot of noise, the noise can be reduced. Note that depending on the turntable, connecting the ground line may have the reverse effect of increasing noise. In this case, it is not necessary to connect the ground line.



Connecting a USB memory device to the USB port

For operating instructions see “Playing a USB memory device” (👉 p. 87).

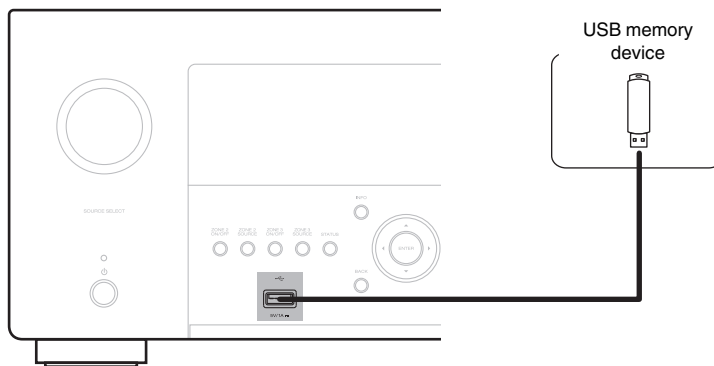

- Denon does not guarantee that all USB memory devices will operate or receive power. When using a portable USB hard disk drive (HDD) which came with an AC adapter, use that device's supplied AC adapter.
- The USB port on the rear panel can only be used to supply power (5 V/1.5 A). It cannot be used to play music files. (👉 p. 26)

NOTE

- USB memory devices will not work via a USB hub.
- It is not possible to use this unit by connecting the unit's USB port to a PC via a USB cable.
- Do not use an extension cable when connecting a USB memory device. This may cause radio interference with other devices.



Connecting to a home network (LAN)

This unit can connect to a network using a wired LAN or wireless LAN. You can connect this unit to your home network (LAN) to enable various types of playback and operations as described below.

- Playback of network audio such as Internet Radio and from your media server(s)
- Playback of streaming music services
- Using the Apple AirPlay function
- Operation on this unit via the network
- Operation with the HEOS wireless multi-room sound system
- Firmware Update

For connections to the Internet, contact an ISP (Internet Service Provider) or a computer shop.

Wired LAN

To make connections via wired LAN, use a LAN cable to connect the router to this unit as shown in the figure below.

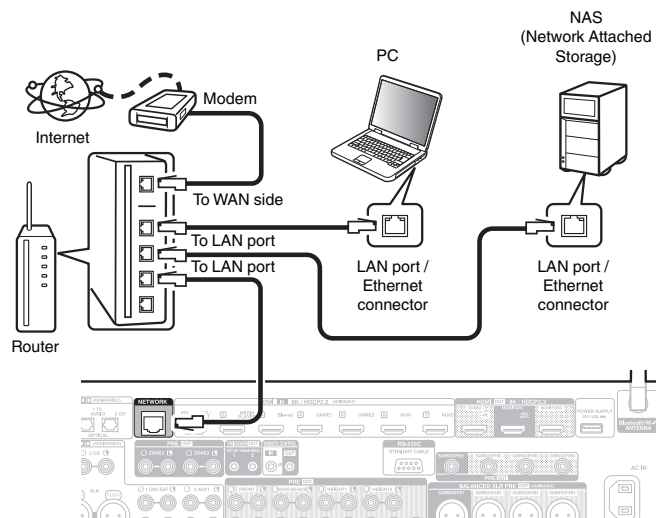

Wireless LAN

When connecting to the network via wireless LAN, connect the external antennas for Bluetooth/wireless connectivity connection to the rear panel and stand them upright.

See “Wi-Fi Setup” on how to connect to a wireless LAN router. (👁 p. 244)

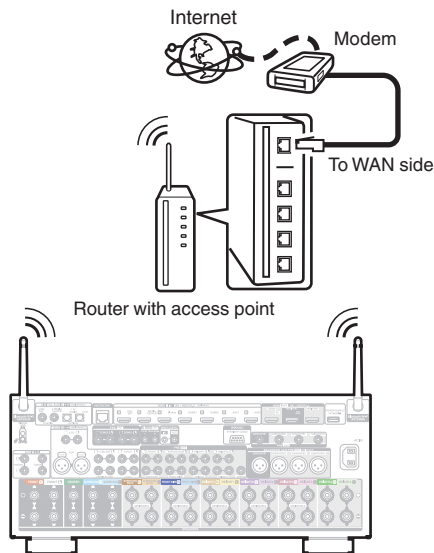

- When using this unit, we recommend you use a router equipped with the following functions:
 - Built-in DHCP server
This function automatically assigns IP addresses on the LAN.
 - Built-in 100BASE-TX switch
When connecting multiple devices, we recommend a switching hub with a speed of 100 Mbps or greater.
- Only use a shielded STP or ScTP LAN cable (readily available at electronics stores). (CAT-5 or greater recommended)
- The normal shielded-type LAN cable is recommended.
If a flat-type cable or unshielded-type cable is used, other devices could be affected by noise.
- When using this unit connected to a network with no DHCP function, configure the IP address, etc. in “Network”. (👁 p. 243)

NOTE

- The types of routers that can be used depend on the ISP. Contact your ISP or a computer shop for details.
- This unit is not compatible with PPPoE. A PPPoE compatible router is required if your contracted line is not set using PPPoE.
- Do not connect a NETWORK connector directly to the LAN port / Ethernet connector on your computer.
- Various online services may be discontinued without prior notice.



Connecting an external control device

REMOTE CONTROL jacks

When this unit is installed in a location where the remote control signals cannot reach (installation in a cabinet etc.), it can still be controlled by the remote control by connecting a remote control receiver unit (sold separately).

You can also use it to remotely control ZONE2 and ZONE3 (another rooms).

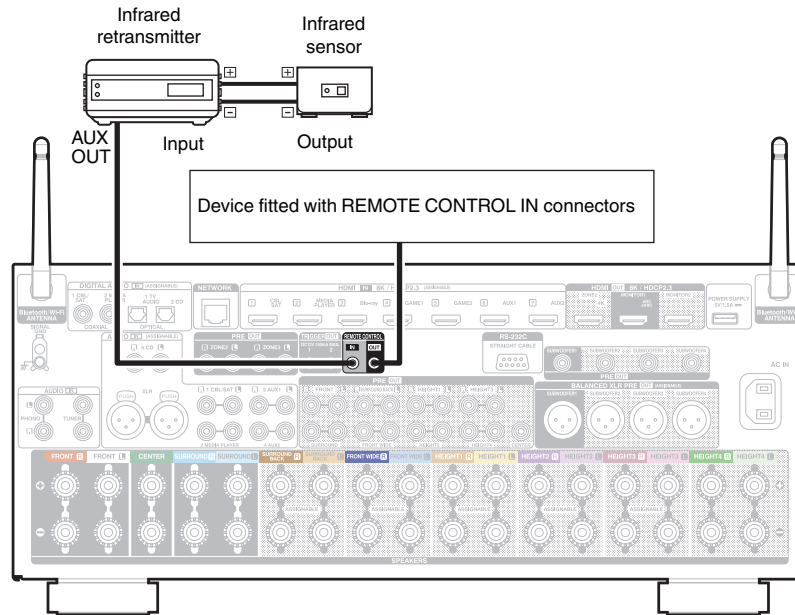

TRIGGER OUT jacks

When a device with TRIGGER IN jack is connected, the connected device's power on/standby can be controlled through linked operation to this unit. The TRIGGER OUT jack outputs a maximum 12 V DC/150 mA electrical signal.

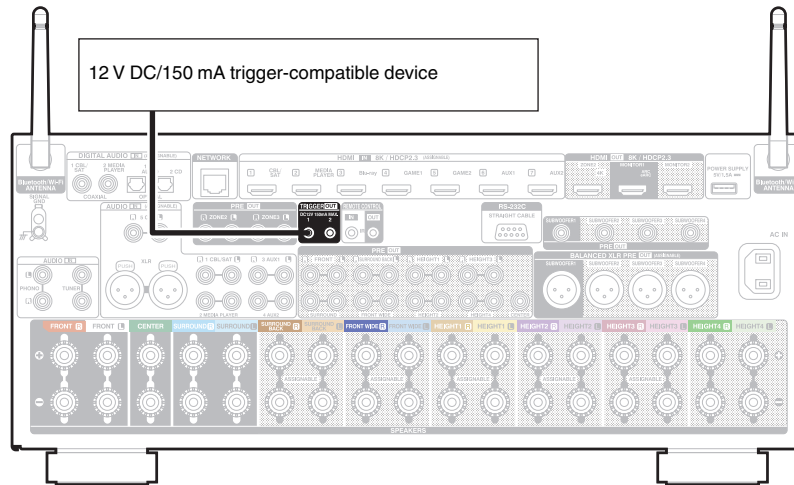

NOTE

- Use a monaural mini-plug cable for connecting the TRIGGER OUT jacks. Do not use a stereo mini-plug cable.
- If the permissible trigger input level for the connected device is larger than 12 V DC/150 mA, or has shorted, the TRIGGER OUT jack cannot be used. In this case, turn off the power to the unit, and disconnect it.



Connecting the power cord

After completing all the connections, insert the power plug into the power outlet.

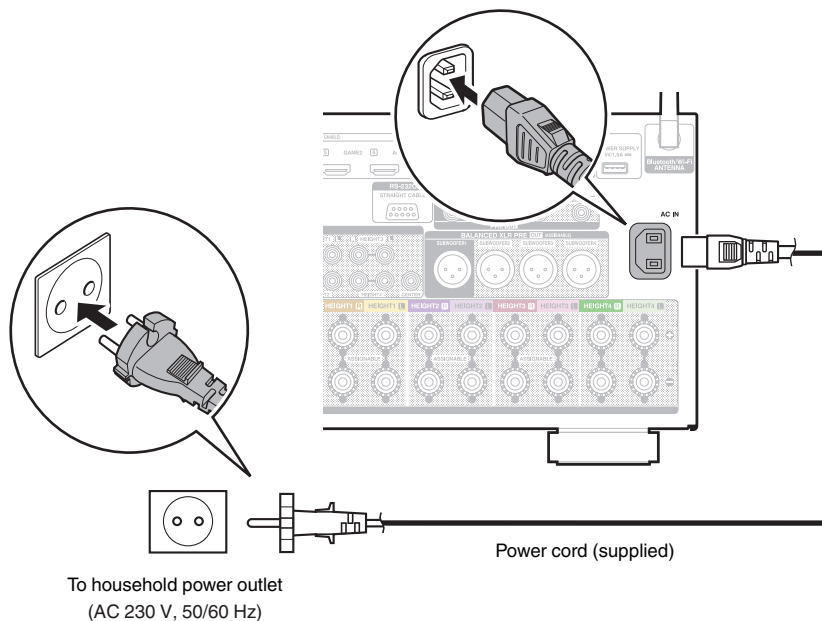

■ Contents

Basic operation

Turning the power on	85
Selecting the input source	85
Adjusting the volume	86
Turning off the sound temporarily (Muting)	86
Selecting a sound mode	127

Playback a device

Playing a Blu-ray Disc player/DVD player	86
Playing a USB memory device	87
Listening to music on a Bluetooth device	91
Listening to audio on Bluetooth headphones	95

Playback network audio/service

Listening to Internet Radio	98
Playing back files stored on a PC or NAS	100
Getting the HEOS App	104
AirPlay function	113
Spotify Connect function	116

Convenience functions

Convenience functions	117
HDMI Control function	141
Sleep timer function	142
Quick select plus function	144
Panel lock function	148
Remote lock function	150

Other functions

Web control function	151
Playback in ZONE2/ZONE3 (Another room)	154



Basic operation

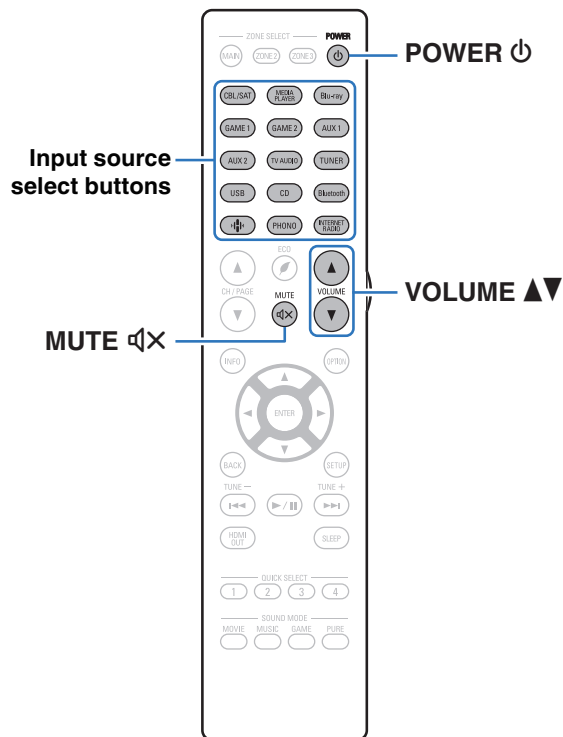

Turning the power on

1 Press **POWER**  to turn on power to the unit.



- You can press the input source select button when the unit is in standby mode to turn on the power.
- You can also switch the power to standby by pressing  on the main unit.

Selecting the input source

1 Press the **input source select button** to be played back.

The desired input source can be selected directly.



- You can also select the input source by turning SOURCE SELECT on the main unit.



Adjusting the volume

1 Use VOLUME ▲▼ to adjust the volume.







- The variable range differs according to the input signal and channel level setting.
- You can also adjust the master volume by turning MASTER VOLUME on the main unit.

Turning off the sound temporarily (Muting)

1 Press MUTE .

- MUTE indicator on the display flashes.
-  appears on the TV screen.



- The sound is reduced to the level set at "Mute Level" in the menu. ( p. 180)
- To cancel mute, either adjust the sound volume or press MUTE  again.
- If  is displayed on the TV screen for more than 5 minutes when the "Screen Saver" is set to "On", the  symbol moves randomly over the TV screen. ( p. 194)

Playback a Blu-ray Disc player/DVD player

The following describes the procedure for playing Blu-ray Disc player/DVD player.

1 Prepare for playback.

- ① Turn on the power of the TV, subwoofer and player.
- ② Change the TV input to the input of this unit.

2 Press POWER to turn on power to the unit.

3 Press Blu-ray or DVD to switch an input source for a player used for playback.

4 Play the Blu-ray Disc player or DVD player.

■ Surround playback (p. 127)



Playing a USB memory device

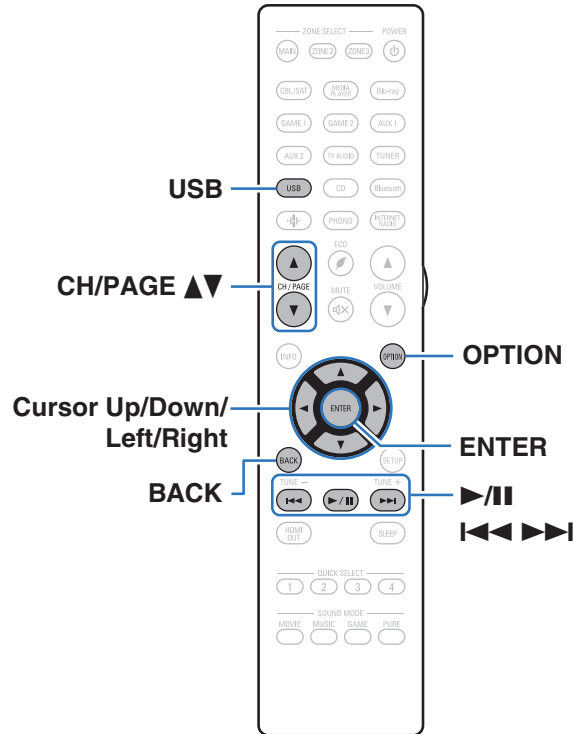

- Playing back music files stored on a USB memory device.
- Only USB memory devices conforming to mass storage class standards can be played on this unit.
- This unit is compatible with USB memory devices in “FAT32” or “NTFS” format.
- The audio format types and specifications supported by this unit for playback are as follows.
See “Playing back a USB memory devices” (👉 p. 304) for details.

- WMA
- MP3
- WAV
- MPEG-4 AAC
- FLAC
- Apple Lossless
- DSD



Playing files stored on USB memory devices

- 1 Insert a “FAT32” or “NTFS” formatted USB memory device into the USB port.
- 2 Press USB to switch the input source to “USB”.
- 3 Select the name of this unit.

4 Browse the music on your USB memory device and select something to play.



- When you select something to play you will be asked how you want to queue up your music.

Play Now:	Inserts the item into the queue after the currently playing track and plays the selected item immediately.
Play Now & Replace Queue:	Clears the queue and plays the selected item immediately.
Play Next:	Inserts the item into the queue after the current song and plays it when the current song ends.
Add to End of Queue:	Adds the item to the end of the queue.

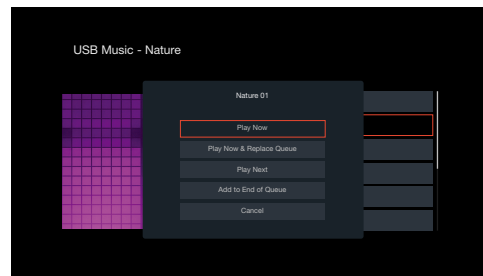

5 Use cursor Up/Down to select the “Play Now” or “Play Now & Replace Queue”, then press ENTER.

Playback starts.

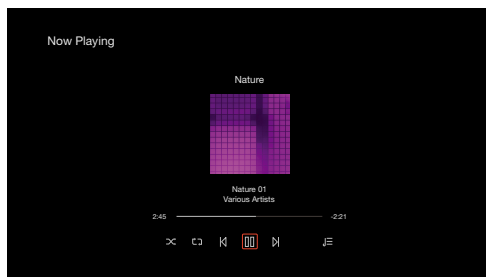

Operation buttons	Function
▶/	Playback / Pause
◀◀▶▶	Skip to previous track / Skip to next track
CH/PAGE ▲▼	Switch to the previous page/next page in the list display



- When an MP3 music file includes album art data, the album art can be displayed while playing the file.

NOTE

- Note that Denon will accept no responsibility whatsoever for any problems arising with the data on a USB memory device when using this unit in conjunction with the USB memory device.
- When a USB memory device is connected to this unit, the unit loads all of the files on the USB memory device. Loading may take a while if the USB memory device contains a large number of folders and/or files.



■ Operations accessible through the option menu

- “Adjusting the audibility of dialog and vocals (Dialog Enhancer)” (🔧 p. 119)
- “Adjusting the volume of each channel to match the input source (Channel Level Adjust)” (🔧 p. 120)
- “Adjusting the tone (Tone)” (🔧 p. 121)
- “Adjusting audio delay (Audio Delay)” (🔧 p. 122)
- “Changing the strength of Tactile Transducer according to the input source (Tactile Transducer)” (🔧 p. 123)
- “Displaying your desired video during audio playback (Video Select)” (🔧 p. 124)
- “Playing the same music in all zones (All Zone Stereo)” (🔧 p. 125)
- “Changing the speaker settings to match the listening environment (Speaker Preset)” (🔧 p. 126)



Listening to music on a Bluetooth device

Music files stored on Bluetooth devices such as smartphones, digital music players, etc. can be enjoyed on this unit by pairing and connecting this unit with the Bluetooth device.

Communication is possible up to a range of about 30 m.

NOTE

- To play back music from a Bluetooth device, the Bluetooth device needs to support the A2DP profile.

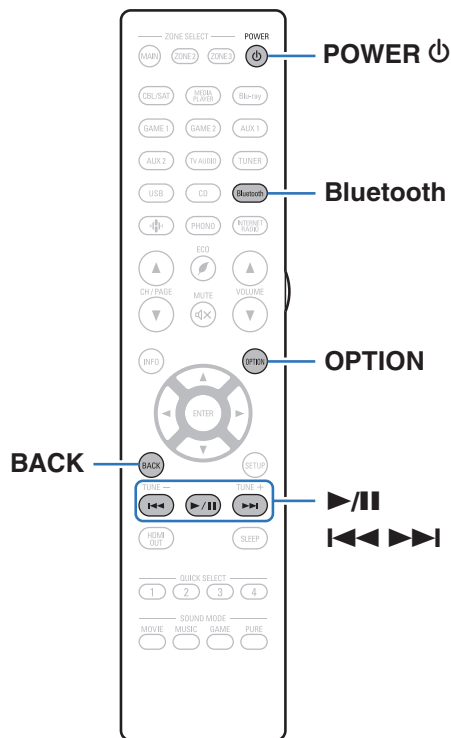

Playing music from Bluetooth device

In order to enjoy music from a Bluetooth device on this unit, the Bluetooth device must first be paired with this unit.

Once the Bluetooth device has been paired, it does not need to be paired again.

1 Prepare for playback.

- ① Connect the supplied external antennas for Bluetooth/wireless connectivity to the Bluetooth/wireless LAN antenna connectors on the rear panel. (☞ p. 25)
- ② Press POWER  to turn on power to the unit.

2 Press Bluetooth.

When using for the first time, the unit will go into the pairing mode automatically and “Pairing...” will appear on the display of the unit.

3 Activate the Bluetooth settings on your mobile device.



4 Select this unit when its name appears in the list of devices displayed on the screen of the Bluetooth device.

Connect to the Bluetooth device while “Pairing” is being displayed on the display of the unit.

Perform the connection with the Bluetooth device close to the unit (about 1 m).

5 Play music using any app on your Bluetooth device.

- The Bluetooth device can also be operated with the remote control of this unit.
- The next time the Bluetooth button is pressed on the remote control unit, this unit automatically connects to the last Bluetooth device that was connected.

Operation buttons	Function
	Playback / Pause
	Skip to previous track / Skip to next track



- Press STATUS on this unit during playback to switch the display between Title name, Artist name, Album name, etc.



Pairing with other Bluetooth devices

Pair a Bluetooth device with this unit.

- 1 Activate the Bluetooth settings on your mobile device.**
- 2 Press and hold Bluetooth on the remote control unit for at least 3 seconds.**
This unit will go into the pairing mode.
- 3 Select this unit when its name appears in the list of devices displayed on the screen of the Bluetooth device.**



- This unit can be paired with a maximum of 8 Bluetooth devices. When a 9th Bluetooth device is paired, it will be registered in place of the oldest registered device.
- You can also enter pairing mode by pressing the OPTION button when the Bluetooth playback screen is displayed and selecting "Pairing Mode" from the displayed option menu.

NOTE

- To operate the Bluetooth device with the remote control of this unit, the Bluetooth device needs to support the AVRCP profile.
- The remote control of this unit is not guaranteed to work with all Bluetooth devices.
- Depending on the type of Bluetooth device, this unit outputs audio that is coupled to the volume setting on the Bluetooth device.

■ Operations accessible through the option menu

- "Pairing with other Bluetooth devices" (👉 p. 93)
- "Adjusting the audibility of dialog and vocals (Dialog Enhancer)" (👉 p. 119)
- "Adjusting the volume of each channel to match the input source (Channel Level Adjust)" (👉 p. 120)
- "Adjusting the tone (Tone)" (👉 p. 121)
- "Adjusting audio delay (Audio Delay)" (👉 p. 122)
- "Changing the strength of Tactile Transducer according to the input source (Tactile Transducer)" (👉 p. 123)
- "Displaying your desired video during audio playback (Video Select)" (👉 p. 124)
- "Playing the same music in all zones (All Zone Stereo)" (👉 p. 125)
- "Changing the speaker settings to match the listening environment (Speaker Preset)" (👉 p. 126)



Reconnecting to this unit from a Bluetooth device

After pairing is completed, the Bluetooth device can be connected without performing any operations on this unit.

This operation also needs to be performed when switching the Bluetooth device for playback.

- 1 If a Bluetooth device is currently connected, deactivate the Bluetooth setting of that device to disconnect it.**
- 2 Activate the Bluetooth setting of the Bluetooth device to be connected.**
- 3 Select this unit from the Bluetooth device list on your Bluetooth device.**
- 4 Play music using any app on your Bluetooth device.**



- The screen automatically switches to the “Bluetooth” playback screen if a Bluetooth device is connected while the power of this unit is on.
- When the “Network Control” setting of this unit is set to “Always On” and a Bluetooth device is connected with the unit in the standby state, the power of the unit will be turned on automatically. (🔗 p. 247)



Listening to audio on Bluetooth headphones

You can listen to audio playing through the MAIN ZONE of this unit on Bluetooth headphones. Output audio from connected speakers and Bluetooth headphones simultaneously, or only using Bluetooth headphones.

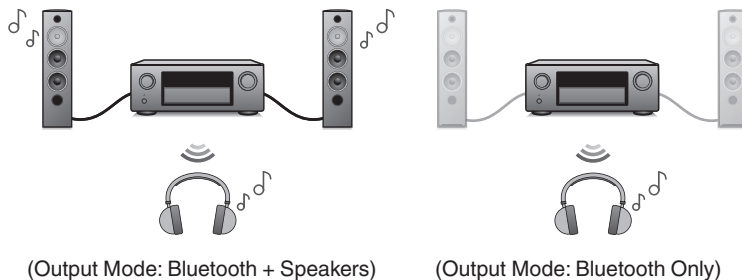

Listening to audio on Bluetooth headphones

- 1 Set “Transmitter” to “On” from the “General” - “Bluetooth Transmitter” setting in the menu. (🔧 p. 256)
- 2 Select “Output Mode”, and set audio output method.

Bluetooth + Speakers (Default):	Audio is output to Bluetooth headphones and main zone speakers. This simultaneous output is suitable for family movie night and other group activities.
Bluetooth Only:	Audio is output to Bluetooth headphones only. This is suitable for listening to music or watching movies by yourself at night when you need to keep quiet.
- 3 Enter pairing mode on the Bluetooth headphones you want to connect to this unit.
- 4 Select “Device List” and select the name of the Bluetooth headphones from the device list.
- 5 Adjust the volume of connected Bluetooth headphones after the connection is completed.



- “Output Mode” can also be set from “Bluetooth Transmitter” in the option menu.
- A2DP profile-compatible Bluetooth speakers can be connected following the same steps used to connect Bluetooth headphones.

NOTE

- Bluetooth headphones volume cannot be adjusted from this unit. Adjust volume of your Bluetooth headphones.
- Stereo mode is fixed as the sound mode when using Bluetooth headphones. Any sound modes and other audio settings are not reflected in audio output on Bluetooth headphones. Audio settings, sound modes and All Zone Stereo mode are not available while using Bluetooth headphones and “Output Mode” is set to “Bluetooth Only”.
- Audio may be delayed when sent over Bluetooth.
- Bluetooth headphones cannot be connected when use a Bluetooth input source in any zone. Furthermore, selecting a Bluetooth input source in any zone will terminate the connection between this unit and Bluetooth headphones.
- Bluetooth headphones cannot be connected when this unit is grouped in the HEOS App.

CAUTION: Using Bluetooth headphones without a volume adjustment function

- In order to avoid hearing loss, do not connect Bluetooth headphones that lack volume adjustment functionality.
- Bluetooth headphone volume may be unexpectedly loud when this unit connects to Bluetooth headphones.
- Bluetooth headphone volume cannot be adjusted from this unit.



Reconnecting to a Bluetooth headphones

Follow any of the steps below to reconnect the most recently used Bluetooth headphones:

- Reconnect to this unit with Bluetooth headphone's reconnect function.
- Go to "Bluetooth Transmitter" and then select "Reconnect" within the options menu.
- If "Output Mode" is set to "Bluetooth + Speakers", this unit will automatically connect to the most recently used Bluetooth headphones when power is turned on.
- Select the device you wish to connect from the "Device List" under "Bluetooth Transmitter" in the menu. (🔍 p. 256)

Disconnecting Bluetooth headphones

Complete any of the following steps to disconnect your Bluetooth headphones:

- Turn off your Bluetooth headphones.
- Go to "Bluetooth Transmitter" and then select "Disconnect" within the options menu.
- In the setup menu, go to "General" - "Bluetooth Transmitter", and set "Transmitter" to Off. (🔍 p. 256)



Listening to Internet Radio

- Internet Radio refers to radio broadcasts distributed over the Internet. Internet Radio stations from around the world can be received.
- The Internet Radio station list on this unit the database service provided by TuneIn Radio service.
- The audio format types and specifications supported by this unit for playback are as follows.
See “Playing back Internet Radio” (📖 p. 307) for details.

- WMA
- MP3
- MPEG-4 AAC

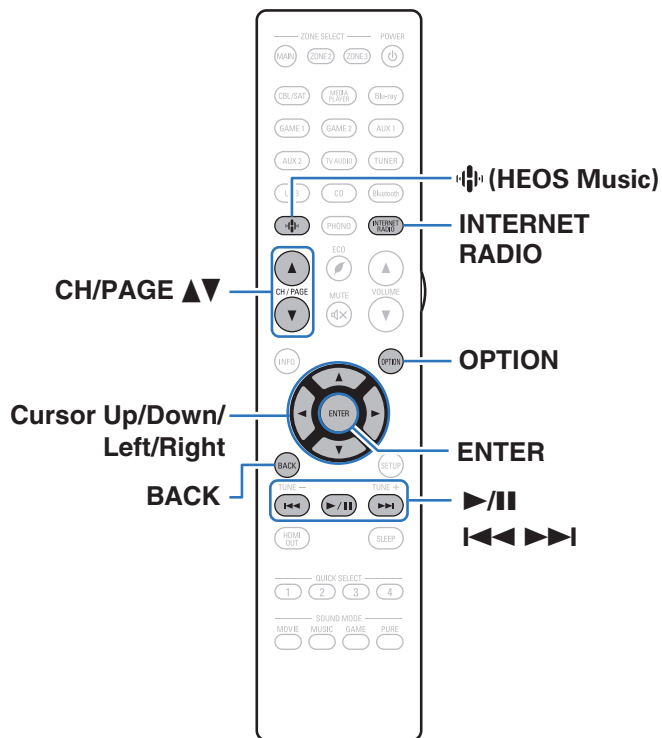



Listening to Internet Radio

1 Press INTERNET RADIO.

- You can also press  (HEOS Music). Use cursor Up/Down to select "TuneIn Internet Radio", then press ENTER.

2 Select the station you want to play.

Operation buttons	Function
	Playback / Stop or Pause*
	Skip to previous track* / Skip to next track*
CH/PAGE 	Switch to the previous page/next page in the list display

* Enabled when playing Podcasts.











- The display switches between track title and radio station name etc. each time the main unit's STATUS is pressed.

NOTE

- The radio station database service may be suspended or be otherwise unavailable without notice.

■ Operations accessible through the option menu

- "Adding to HEOS Favorites" ( p. 118)
- "Adjusting the audibility of dialog and vocals (Dialog Enhancer)" ( p. 119)
- "Adjusting the volume of each channel to match the input source (Channel Level Adjust)" ( p. 120)
- "Adjusting the tone (Tone)" ( p. 121)
- "Adjusting audio delay (Audio Delay)" ( p. 122)
- "Changing the strength of Tactile Transducer according to the input source (Tactile Transducer)" ( p. 123)
- "Displaying your desired video during audio playback (Video Select)" ( p. 124)
- "Playing the same music in all zones (All Zone Stereo)" ( p. 125)
- "Changing the speaker settings to match the listening environment (Speaker Preset)" ( p. 126)



Playing back files stored on a PC or NAS

- This unit can play back music files and playlists (m3u, wpl) from DLNA compatible servers including PCs and NAS devices on your network.

- Supported file formats:
For details, see “Playing back a file saved on a PC or NAS” (🔍 p. 306).

- WMA
- MP3
- WAV
- MPEG-4 AAC
- FLAC
- Apple Lossless
- DSD

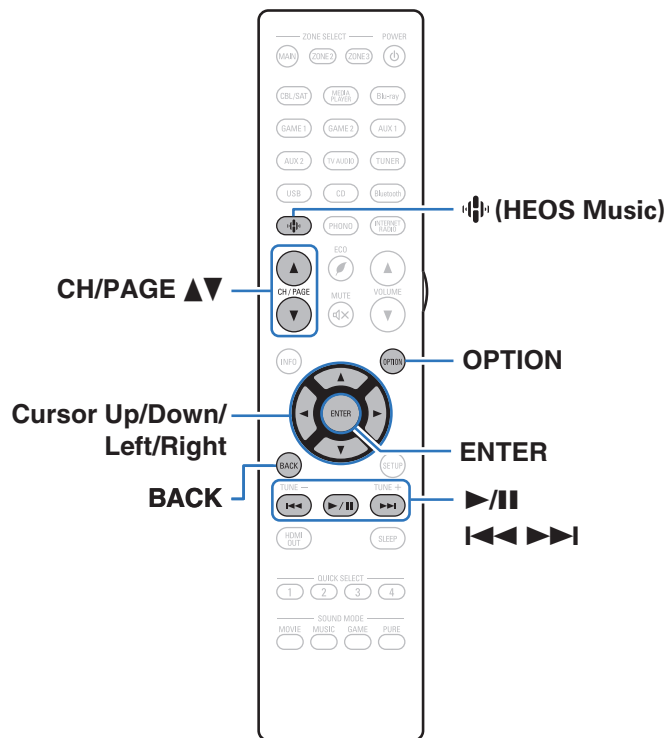

Playing back files stored on a PC or NAS

Use this procedure to play music files or playlists stored on DLNA files servers on your local network.

- 1 Press **HEOS Music**.
- 2 Use cursor Up/Down to select “Music Servers”, then press ENTER.

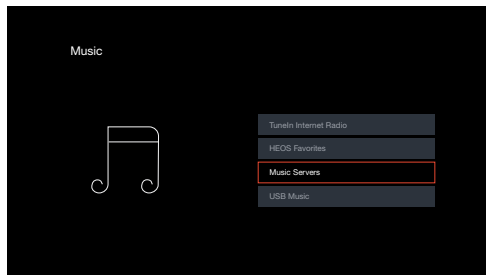

- 3 Select the name of your networked PC or NAS (Network Attached Storage) server.

4 Browse the music on your PC/NAS and select something to play.



- When you select something to play you will be asked how you want to queue up your music.

Play Now:	Inserts the item into the queue after the currently playing track and plays the selected item immediately.
Play Now & Replace Queue:	Clears the queue and plays the selected item immediately.
Play Next:	Inserts the item into the queue after the current song and plays it when the current song ends.
Add to End of Queue:	Adds the item to the end of the queue.

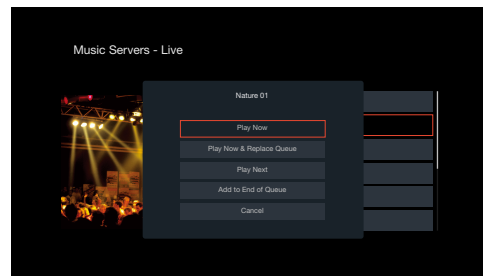

5 Use cursor Up/Down to select the “Play Now” or “Play Now & Replace Queue”, then press ENTER.

Playback starts.

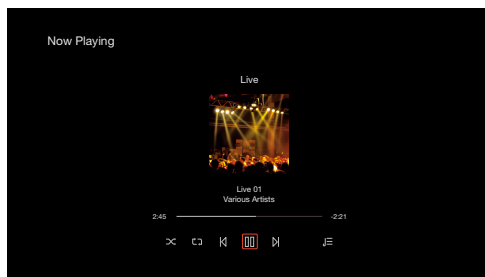

Operation buttons	Function
▶/	Playback / Pause
◀◀▶▶	Skip to previous track / Skip to next track
CH/PAGE ▲ ▼	Switch to the previous page/next page in the list display



- The display switches between track title, artist name, and album title each time the main unit's STATUS is pressed.
- When a WMA (Windows Media Audio), MP3 or MPEG-4 AAC file includes album art data, the album art can be displayed while the music files are playing.
- If you use Ver.11 or later of Windows Media Player, the album art for WMA files can be displayed.

NOTE

- When playing back music files with your PC or NAS connected through wireless LAN, audio may be interrupted depending on your wireless LAN environment. In this case, connect using a wired LAN.
- The order in which the tracks/files are displayed depends on the server specifications. If the tracks/files are not displayed in alphabetical order due to the server specifications, searching by the first letter may not work properly.



■ Operations accessible through the option menu

- “Adjusting the audibility of dialog and vocals (Dialog Enhancer)” (🔧 p. 119)
- “Adjusting the volume of each channel to match the input source (Channel Level Adjust)” (🔧 p. 120)
- “Adjusting the tone (Tone)” (🔧 p. 121)
- “Adjusting audio delay (Audio Delay)” (🔧 p. 122)
- “Changing the strength of Tactile Transducer according to the input source (Tactile Transducer)” (🔧 p. 123)
- “Displaying your desired video during audio playback (Video Select)” (🔧 p. 124)
- “Playing the same music in all zones (All Zone Stereo)” (🔧 p. 125)
- “Changing the speaker settings to match the listening environment (Speaker Preset)” (🔧 p. 126)



Getting the HEOS App

You can use many online music streaming services from the HEOS App. Depending upon your geographical location, there are several options to choose from.

Download the HEOS App for iOS or Android by searching App Store, Google Play store or Amazon Appstore for "HEOS".



HEOS Account

HEOS Accounts can be registered in “HEOS Account” (👉 p. 251) in the menu of this unit or by tapping “Music” tab - “Settings” icon ⚙️ in the HEOS App.

■ What is a HEOS Account?

A HEOS Account is master account or “keychain” for managing all of your HEOS music services with one single username and password.

■ Why do I need a HEOS Account?

With the HEOS Account you just have to enter your music services login names and passwords one time. This allows you to easily and quickly use multiple controller apps on different devices.

You just log into your HEOS Account on any device and you will have access to all of your associated music services, play history and custom playlists, even if you are at a friend’s house listening to music on their HEOS system.

■ Signing up for a HEOS Account

You will be instructed to signup for a HEOS Account the first time you try to access any music service from the main “Music” menu of the HEOS App.

■ Changing your HEOS Account

- 1 Tap the “Music” tab.
- 2 Select the Settings icon ⚙️ in the upper left corner of the screen.
- 3 Select “HEOS Account”.
- 4 Change your location, change your password, delete your account or sign out of your account.



Playing from streaming music services

A music service is an online music company that provides access to vast music collections via free and/or paid subscriptions. Depending upon your geographical location, there are several options to choose from.

NOTE

- The HEOS App and brand is not affiliated with any manufacturer of any mobile device. Availability of music services may vary by region. Not all services may be available at time of purchase. Some services may be added or discontinued from time to time based on decisions of the music service providers or others.

■ Selecting a room/device

- 1 Tap the “Rooms” tab, and select “Denon AVC-A1H” if there are multiple products with HEOS Built-in.



- Tap the Pencil icon  at the top right to switch edit mode. You can change the displayed name.

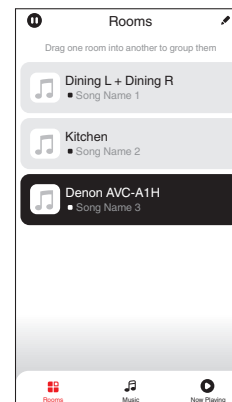

■ Selecting the music track or station from music sources

1 Tap the “Music” tab and select a music source.



- All music services displayed may not be available in your location.

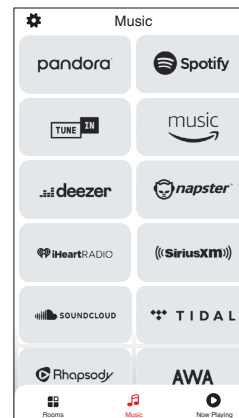

2 Browse the music to play.

After selecting a music track or radio station the app will automatically change to the “Now Playing” screen.



- When you select a music track to play you will be asked how you want to queue up your music.

Play Now:	Inserts the item into the queue after the currently playing track and plays the selected item immediately.
Play Now & Replace Queue:	Clears the queue and plays the selected item immediately.
Play Next:	Inserts the item into the queue after the current song and plays it when the current song ends.
Add to End of Queue:	Adds the item to the end of the queue.



- When you select a radio station the following items are displayed.

Play Now:	Plays the selected item immediately.
Add to HEOS Favorites:	Adds to HEOS Favorites.

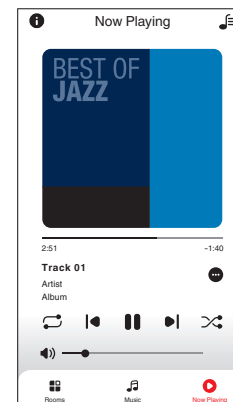
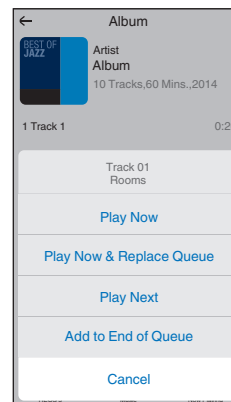

Listening to the same music in multiple rooms

This system is a true multi-room audio system. You can create one or more HEOS groups to automatically synchronize audio playback between multiple products with HEOS Built-in so that the music playing different rooms is perfectly in sync and always sounds amazing! You can easily add up to 32 products to your system in total. You can group up to 16 individual products to have them play the same song fully synchronized.

■ Grouping rooms

- 1** Press and hold your finger on room that is not playing music.
- 2** Drag it into the room that is playing music and lift your finger.
- 3** The two rooms will be grouped together into a single device group and both rooms will be playing the same music in perfect sync.

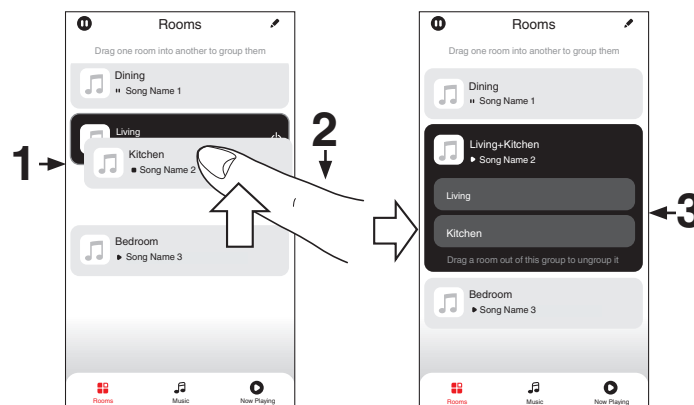

■ Ungrouping rooms

- 1** Press and hold your finger on room that you want to remove from the group.
- 2** Drag it out of the group and lift your finger.

NOTE

- You can not remove the first room that started playing the music before grouping.

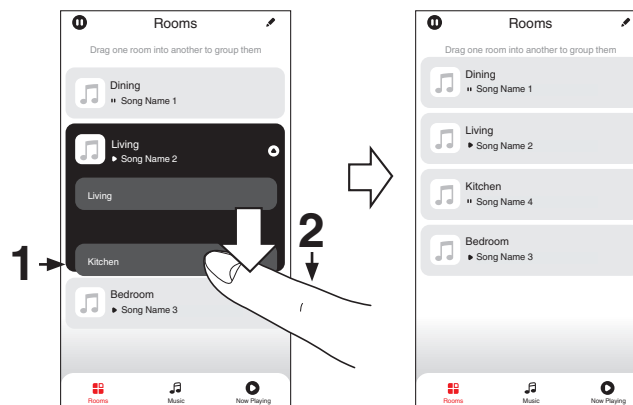

■ Grouping all rooms (party mode)

You can easily group 16 rooms together into Party Mode by using a "pinch" gesture.

- 1** Place two fingers on the screen over the list of rooms.
- 2** Quickly pinch your two fingers together and release.
- 3** All of your rooms will be joined together and begin playing the same music in perfect sync.



■ Ungrouping all rooms

You can easily ungroup all of your rooms and exit Party Mode by using a "spread" gesture.

- 1 Place two fingers close together on the screen over list of rooms.**
- 2 Quickly spread your two fingers apart from each other and release.**
- 3 All of your rooms will be ungrouped.**

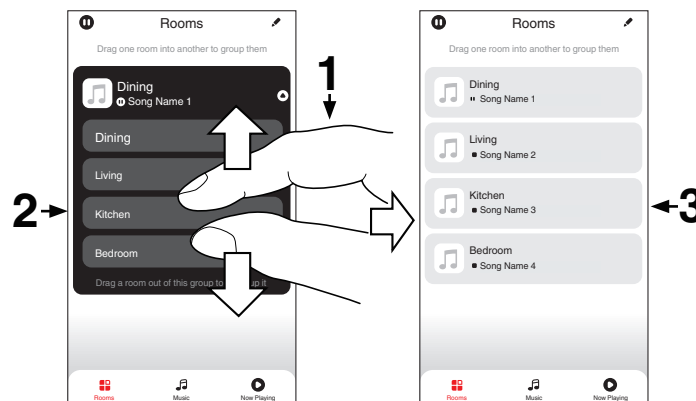

AirPlay function

Music files stored on your iPhone, iPod touch, iPad or iTunes can be played on this unit via the network.



- Source input will be switched to “HEOS Music” when AirPlay playback is started.
- You can stop AirPlay playback by choosing other input source.
- To see song and artist names together, press STATUS on the main unit.
- For information about how to use iTunes, also see the Help for iTunes.
- The screen may differ depending on the OS and software versions.

This unit supports AirPlay 2.

Sync multiple AirPlay 2 compatible devices/speakers for simultaneous playback.



- This unit supports AirPlay 2 and requires iOS 11.4 or later.

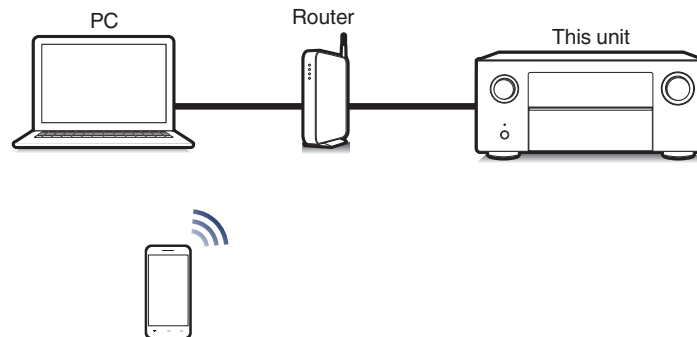

Playing songs from your iPhone, iPod touch or iPad

If you update your “iPhone/iPod touch/iPad” to iOS 10.0.2 or later, you can stream music stored in your “iPhone/iPod touch/iPad” directly to this unit.

1 Connect your iPhone, iPod touch or iPad Wi-Fi to the same network as this unit.

- For details, see your device’s manual.

2 Play the song on your iPhone, iPod touch or iPad.

AirPlay icon is displayed on the iPhone, iPod touch or iPad screen.

3 Tap the AirPlay icon and select this unit.

[Example] iOS 15

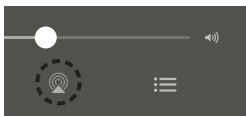

[Example] iOS 10



Playing iTunes music with this unit

1 Install iTunes 10, or later, on a Mac or Windows PC that is connected to the same network as this unit.

2 Turn this unit ON.

Set “Network Control” to “Always On” for this unit. (☞ p. 247)

NOTE

- When “Network Control” is set to “Always On”, the unit consumes more standby power.

3 Start iTunes and click the AirPlay icon to select this unit.

[Example] iTunes

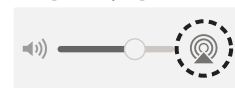

4 Choose a song and click play in iTunes.

The music will stream to this unit.



NOTE

- In playback using the AirPlay function, the sound is output at the iPhone, iPod touch, iPad or iTunes volume setting level. You should turn down the iPhone, iPod touch, iPad or iTunes volume prior to playback and then adjust it to a suitable level.

Play a song from your iPhone, iPod touch or iPad on multiple synced devices (AirPlay 2)

Songs from an iPhone, iPod touch or iPad operating iOS 11.4 or later can be synced with multiple AirPlay 2 supported devices for simultaneous playback.

1 Play the song on your iPhone, iPod touch or iPad.

AirPlay icon is displayed on the iPhone, iPod touch or iPad screen.

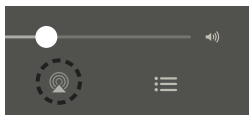

2 Tap the AirPlay icon and select this unit.

Displays a list of devices/speakers that can be played back on the same network.

- A circle is displayed to the right of AirPlay 2 compatible devices.

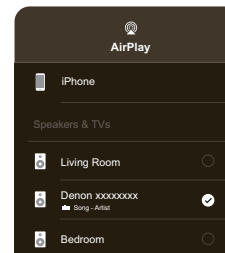

3 Tap the devices/speakers you want to use.

- Multiple AirPlay 2 compatible devices can be selected.

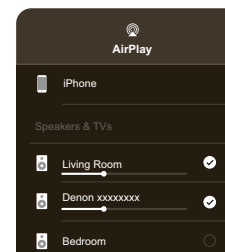

Spotify Connect function

Spotify is all the music you'll ever need. Millions of songs available instantly. Just search for the music you love, or let Spotify play you something great. Spotify works on your phone, tablet, computer and home speakers. So you'll always have the perfect soundtrack for whatever you're doing. Now you can enjoy Spotify with your free account as well as Premium account.

Use your phone, tablet or computer as a remote control for Spotify.

Go to www.spotify.com/connect to learn how.

The Spotify software is subject to third party licenses found here:

www.spotify.com/connect/third-party-licenses

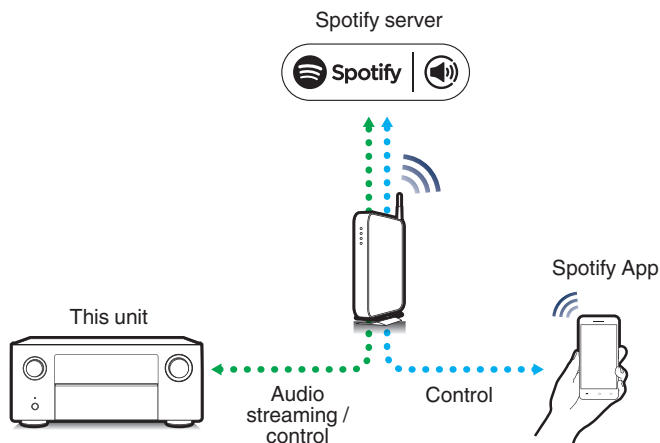

Playing Spotify music with this unit

Download the "Spotify App" onto your Android or iOS device beforehand.

- 1** Connect the Wi-Fi settings of the iOS or Android device in the same network as this unit.
- 2** Launch the Spotify App.
- 3** Play back the Spotify track.
- 4** Tap the Spotify icon  to select the unit.
The music will stream to this unit.



Convenience functions

This section explains how to use convenient functions that can be used for each input source.

These functions can only be set in the MAIN ZONE.

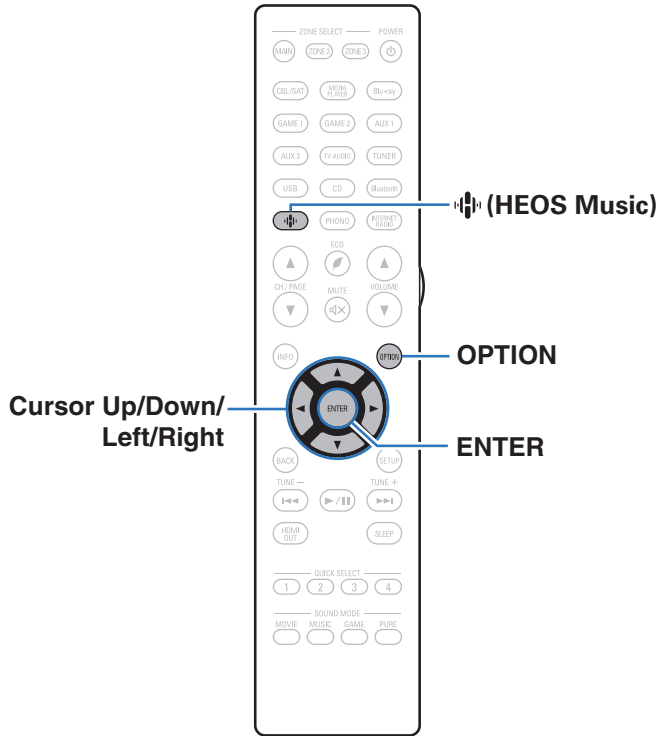

Adding to HEOS Favorites

- 1 While content is playing, press OPTION.**
The option menu screen is displayed.
- 2 Use cursor Up/Down to select “Add to HEOS Favorites”, then press ENTER.**

Playing back HEOS Favorites

- 1 Press  (HEOS Music).**
- 2 Use cursor Up/Down to select “HEOS Favorites”, then press ENTER.**

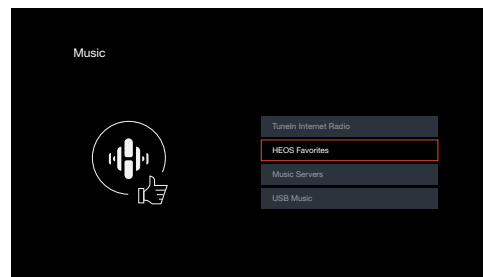

- 3 Browse the content and select something to play.**



Deleting a HEOS Favorites

- 1** While the HEOS Favorites content list is displayed, use cursor Up/Down to select the item you want to remove from HEOS Favorites, then press **OPTION**.
- 2** Use cursor Up/Down to select “Remove from HEOS Favorites”, then press **ENTER**.

Adjusting the audibility of dialog and vocals (Dialog Enhancer)

This function adjusts the center channel frequency band to enhance the dialog in the movies and vocals in music for easier listening.

- 1 Press **OPTION**.**
An option menu screen is displayed.
 - When the input source is “HEOS Music”, an option menu for online music is displayed. Select “AVR Options...”, then press **ENTER**.
- 2 Use cursor Up/Down to select “Dialog Enhancer”, then press **ENTER**.**
The “Dialog Enhancer” screen is displayed.
- 3 Use cursor Left/Right to select your favorite enhancement effect.**

Low / Medium / High:	Enhances the dialog and vocals.
Off (Default):	Does not enhance the dialog or vocals.

- 4 Press **ENTER**.**



- “Dialog Enhancer” settings are stored for each source.
- This cannot be set when the sound mode is set to “Direct”, “Virtual” or “Pure Direct”.



Adjusting the volume of each channel to match the input source (Channel Level Adjust)

The volume of each channel can be changed while listening to music. You can set this for each input source.

1 Press OPTION.

An option menu screen is displayed.

- When the input source is "HEOS Music", an option menu for online music is displayed. Select "AVR Options...", then press ENTER.

2 Use cursor Up/Down to select "Channel Level Adjust", then press ENTER.

The "Channel Level Adjust" screen is displayed.

3 Use cursor Up/Down to select the channel that you wish to adjust.

4 Use cursor Left/Right to adjust the volume.

-12.0 dB – +12.0 dB (Default: 0.0 dB)

5 Use cursor Up/Down/Left/Right to select "Exit", then press ENTER.



- Select "Reset" and press ENTER if you want to restore the adjustment values of the various channels to "0.0 dB" (Default).
- Headphone volume can be adjusted when a headphone is connected.
- "Channel Level Adjust" settings are stored for each input source.
- You can only set this for speakers that output audio. In addition, you cannot set this when in the menu "HDMI Audio Out" is set to "TV". (🔗 p. 186)



Adjusting the tone (Tone)

Adjusts the tonal quality of the front speakers.

1 Press OPTION.

An option menu screen is displayed.

- When the input source is "HEOS Music", an option menu for online music is displayed. Select "AVR Options...", then press ENTER.

2 Use cursor Up/Down to select "Tone", then press ENTER.

The "Tone" screen is displayed.

3 Use cursor Left/Right to set the tone control function to on/off.

On:	Allow tone adjustment (bass, treble).
Off (Default):	Playback without tone adjustment.

4 Select "On" in step 3 and press cursor Down to select the sound range to be adjusted.

Bass:	Adjust bass.
Treble:	Adjust treble.

5 Use cursor Left/Right to adjust the tone, then press ENTER.

-6 dB – +6 dB (Default : 0 dB)



- "Tone" settings are stored for each input source.
- This cannot be set when the sound mode is set to "Direct" or "Pure Direct".
- This item cannot be set when "Dynamic EQ" is set to "On". (👉 p. 182)
- You cannot set this when no audio signal is input or in the menu "HDMI Audio Out" is set to "TV". (👉 p. 186)



Adjusting audio delay (Audio Delay)

Compensates for incorrect timing between video and audio.

1 Press OPTION.

An option menu screen is displayed.

- When the input source is "HEOS Music", an option menu for online music is displayed. Select "AVR Options...", then press ENTER.

2 Use cursor Up/Down to select "Audio Delay", then press ENTER.

The "Audio Delay" screen is displayed.

3 Use cursor Left/Right to set the auto lip sync function to on/off.

On (Default):	Automatically adjusts the audio processing time to compensate for delays in audio/video timing from TV compatible with Auto Lip Sync.
Off:	Do not adjust automatically.

4 Press cursor Down to select "Adjust" if the timing mismatch between the picture and sound need to be corrected manually, then use cursor Left/Right to adjust the timing.

0 ms – 500 ms (Default : 0 ms)



- "Audio Delay" settings are stored for each input source.
- Automatic correction may not be performed depending on the specifications of your TV even when "Auto Lip Sync" is set to "On".
- You can also finely adjust the delay correction value set by "Auto Lip Sync".



Changing the strength of Tactile Transducer according to the input source (Tactile Transducer)

Adjusts the volume of the tactile transducer output.

1 Press OPTION.

An option menu screen is displayed.

- When the input source is "HEOS Music", an option menu for online music is displayed. Select "AVR Options...", then press ENTER.

2 Use cursor Up/Down to select "Tactile Transducer", then press ENTER.

The "Tactile Transducer" screen is displayed.

3 Use cursor Left/Right to set the tactile transducer function to on/off.

On (Default):	Enable tactile Transducer.
Off:	Disable tactile Transducer.

4 If you selected "On" in step 3, press cursor Down and adjust the "Level".

5 Use cursor Left/Right to adjust the tone, then press ENTER.

-12.0 dB – +12.0 dB (Default : 0.0 dB)



- "Tactile Transducer" settings are stored for each input source.
- This cannot be set when the "Speakers" - "Manual Setup" - "Tactile Transducer Setup" - "Tactile Transducer" is set to "Disabled".



Displaying your desired video during audio playback (Video Select)

This unit can display video from a different source on TV during audio playback. You can set this for each input source.

❑ Supported input sources:

CD* / Tuner / HEOS Music / Phono

* This cannot be set when any of the HDMI connector is assigned.

1 Press OPTION.

An option menu screen is displayed.

- When the input source is "HEOS Music", an option menu for online music is displayed. Select "AVR Options...", then press ENTER.

2 Use cursor Up/Down to select "Video Select", then press ENTER.

The "Video Select" screen is displayed.

3 Use cursor Left/Right to select the Video Select mode.

Off (Default):	Disable Video Select mode.
On:	Enable Video Select mode.

4 If you selected "On" in step 3, press cursor Down and select "Source".

5 Use cursor Left/Right to select the input source for video you want to play back, then press ENTER.



- "Video Select" settings are stored for each input source.



Playing the same music in all zones (All Zone Stereo)

You can play back the music being played back in MAIN ZONE simultaneously in ZONE2 and ZONE3 (another rooms).

It is useful when you want to enjoy the same music at the same time in multiple rooms during home party or when you want to play back the same background music in the entire house.

1 Press OPTION.

An option menu screen is displayed.

- When the input source is "HEOS Music", an option menu for online music is displayed. Select "AVR Options...", then press ENTER.

2 Use cursor Up/Down to select "All Zone Stereo", then press ENTER.

The "All Zone Stereo" screen is displayed.

3 Select "Start", then press ENTER.

- The input sources for ZONE2 and ZONE3 are switched to the same input source as for MAIN ZONE, and playback starts in the All Zone Stereo mode.
- When you do not want ZONE2 or ZONE3 to participate in All Zone Stereo, press ENTER to clear the check mark and then press "Start".

■ Stopping the All Zone Stereo mode

1 During playback in All Zone Stereo mode, press OPTION.

An option menu screen is displayed.

- When the input source is "HEOS Music", an option menu for online music is displayed. Select "AVR Options...", then press ENTER.

2 Use cursor Up/Down to select "All Zone Stereo", then press ENTER.

3 Select "Stop", then press ENTER.



- The All Zone Stereo mode is canceled even when the power supply of the MAIN ZONE is turned off.
- In the All Zone Stereo mode, only the "Multi Ch Stereo" and "Stereo" sound modes can be selected.
- When "HDMI Audio Out" is set to "TV", the All Zone Stereo mode is not available. (p. 186)
- Save the All Zone Stereo mode playback status to the Quick Select Plus function to enable simple playback in All Zone Stereo mode with a single touch.



Changing the speaker settings to match the listening environment (Speaker Preset)

Two speaker settings can be saved to suit the environments where you use your speakers.

1 Press **OPTION**.

An option menu screen is displayed.

- When the input source is “HEOS Music”, an option menu for online music is displayed. Select “AVR Options...”, then press **ENTER**.

2 Use cursor **Up/Down** to select “Speaker Preset”, then press **ENTER**.

The “Speaker Preset” screen is displayed.

3 Use cursor **Left/Right** to set the preset.

Preset 1 (Default):	Use Preset 1.
Preset 2:	Use Preset 2.



- This function can be used in the following cases.
 - Adjust the speaker settings manually after setting “Speaker Preset” to “Speaker Preset 2”.
 - Save the result to “Speaker Preset 2” after performing Audyssey® Setup for a second time.



Selecting a sound mode

This unit allows you to enjoy various kinds of surround and stereo playback modes. Disc formats such as Blu-ray Disc and DVD, as well as being supported by digital broadcasting, and even by streaming movies and music from internet-based subscription services.

This unit supports playback of almost all of these multi-channel audio formats. It also supports surround playback of audio formats other than multi-channel audio such as 2-channel stereo audio.



- For audio formats recorded on a disc, see the disc jacket or label.

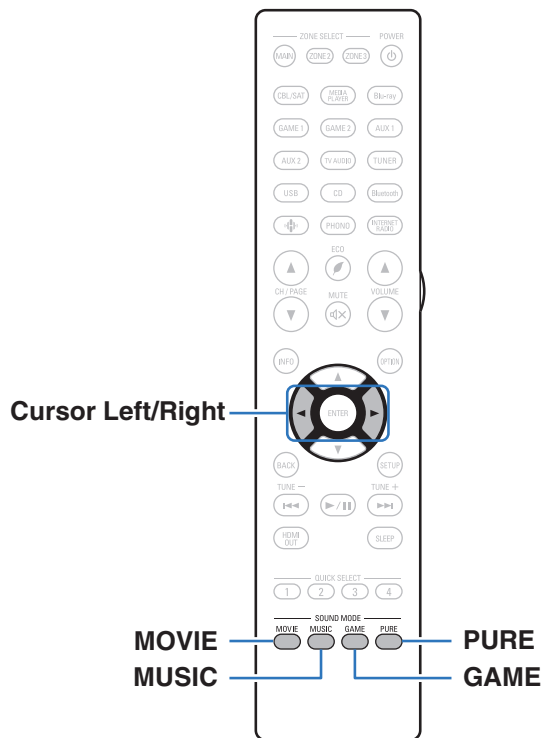

Selecting a sound mode

1 Press **MOVIE**, **MUSIC** or **GAME** to select a sound mode.

MOVIE :	Switches to the sound mode suitable for enjoying movies and TV programs.
MUSIC :	Switches to the sound mode suitable for enjoying music.
GAME :	Switches to the sound mode suitable for enjoying games.



- The **MOVIE**, **MUSIC**, or **GAME** button memorizes the last sound mode selected for its button. Pressing **MOVIE**, **MUSIC**, or **GAME** recalls the same sound mode as the one selected at the previous playback.
- If the content played back does not support the previously selected sound mode, the most appropriate sound mode for the content is automatically selected.

■ Switching the sound mode

- Each time you press **MOVIE**, **MUSIC** or **GAME**, the sound mode changes.
- While the sound mode is displayed, you can also use cursor Left/Right to select a sound mode.
- Try out various sound modes and enjoy sound mode in your favorite mode.



- Please set the surround mode to Dolby Atmos/Surround when playing back Dolby Atmos encoded content. Dolby Atmos/Surround delivers the optimum playback experience from Blu-ray and streaming sources encoded with Dolby Atmos as well as channel based content. The default setting of this receiver is Dolby Atmos/Surround.



[Example] When MOVIE is pressed

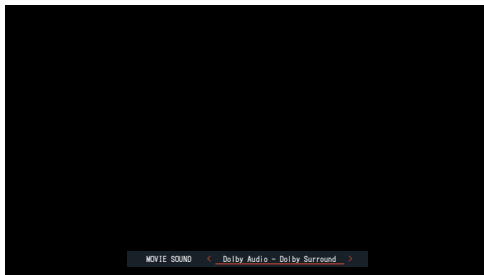

This unit provides not only sound modes that conform to the formats recorded on discs such as Dolby and DTS, but also extended types of modes that match your speaker configuration and “original sound modes” that create atmosphere of Rock Arena and Jazz Club, etc.

Direct playback

Sound recorded in source is played as is.

1 Press PURE to select “Direct”.

Direct playback begins.



- While DSD signals are played back, “DSD Direct” is displayed.



Pure Direct playback

This mode is for playback with higher sound quality than in Direct playback mode.

This mode turns off the main unit display. Doing so suppresses noise sources that affect sound quality.

1 Press PURE to select “Pure Direct”.

The display goes dark, and Pure Direct playback begins.



• In Direct and Pure Direct sound modes, the following items cannot be adjusted.

- Dialog Enhancer (🔧 p. 119)
- Tone (🔧 p. 121)
- Restorer (🔧 p. 179)
- MultEQ® XT32 (🔧 p. 181)
- Dynamic EQ (🔧 p. 182)
- Dynamic Volume (🔧 p. 183)
- Graphic EQ (🔧 p. 184)

NOTE

- Video signals are only output when HDMI signals are played in the Pure Direct mode.
- When the Pure Direct mode has been selected, the display turns off after about 5 seconds.

Auto surround playback

This mode detects the type of input digital signal, and automatically selects the corresponding mode for playback.

Perform stereo playback when the input signal is PCM. When the input signal is Dolby Digital or DTS, the music is played back according to the respective channel number.

1 Press PURE to select “Auto”.

Auto surround playback begins.



Description of sound mode types

Dolby sound mode

Sound mode type	Description
Dolby Atmos	Please select this mode to play content encoded with Dolby Atmos. If you have selected a different sound mode previously, please select again this mode for Dolby Atmos content play back. It decodes Dolby Atmos content and its positioning data in real time and outputs audio from the appropriate speakers, creating natural audio images regardless of the speaker layout. Use ceiling speakers and/or Dolby Atmos Enabled speakers to realize a three-dimensional sound field. An immersive audio experience can be enjoyed from traditional speaker layouts that do not employ overhead or Dolby Atmos Enabled Speakers by selecting the Speaker Virtualizer feature.
Dolby TrueHD	Please select this mode to play back the contents encoded with Dolby TrueHD at 192kHz/96kHz.
Dolby Digital Plus	Please select this mode to play back the contents encoded with Dolby Digital Plus.
Dolby Digital	Please select this mode to play back the contents encoded with Dolby Digital.
Dolby Surround	This mode uses Dolby Surround Upmixer to extend various sources to natural and realistic multi channels for playback. Use ceiling speakers such as top middle speakers to realize a three-dimensional sound field.



DTS sound mode

Sound mode type	Description
DTS Surround	This mode can be selected when playing sources recorded in DTS.
DTS-HD	This mode can be selected when playing sources recorded in DTS-HD.
DTS:X	This mode can be selected when playing back content encoded with DTS:X. It decodes DTS:X content and its positioning data in real time and outputs audio from the appropriate speakers, creating natural audio images regardless of the speaker layout. Use height speakers to realize a three-dimensional sound field.
IMAX DTS	This mode is automatically activated when playing back IMAX Enhanced content featuring a DTS bitstream. (🔍 p. 174) <ul style="list-style-type: none"> When “Speaker Configuration” - “Surround Back” is set to “2 spkr”, “Speaker Configuration” - “Center” is set to “Large” or “Small”, and sound mode is set to “IMAX DTS”, surround audio is output from the surround back speaker. Audio is not output from the surround speaker. The bass information of speakers are not redirected to the subwoofer, but getting a better bass effect from front and center speakers by special algorithm of IMAX when the “Front” and “Center” are set to “Small”.
IMAX DTS:X	This mode is automatically activated when playing back IMAX Enhanced content featuring a DTS:X bitstream. (🔍 p. 174) <ul style="list-style-type: none"> The bass information of speakers are not redirected to the subwoofer, but getting a better bass effect from front and center speakers by special algorithm of IMAX when the “Front” and “Center” are set to “Small”.



Sound mode type	Description
DTS Neural:X	This mode uses DTS Neural:X Upmixer to extend various sources to natural and realistic multi channels for playback. Use height speakers such as front height speakers to realize a three-dimensional sound field.
DTS Virtual:X*1*2	This mode uses DTS Virtual:X with virtual height and virtual surround processing to realize a three-dimensional sound field when the height speakers are not used.

*1 It cannot be selected when the input signal is Dolby Digital, Dolby Digital Plus, Dolby TrueHD or Dolby Atmos.

*2 This can be selected when Height, Ceiling and Dolby Atmos Enabled speakers are not being used.

Auro-3D sound mode

Sound mode type	Description
Auro-3D	This mode uses an Auro-3D decoder to create three-dimensional audio output using the Height Channel. It is ideal for playback of signals encoded as Auro-3D with a Height Channel. If signals not encoded as Auro-3D are input, an Upmixer called the Auro-Matic is used to create highly realistic three-dimensional audio output.
Auro-2D Surround	This mode uses an Auro-3D decoder to create Surround Sound without a Height Channel. It is ideal for playback of signals encoded as Auro-3D without a Height Channel. If signals not encoded as Auro-3D are input, an Upmixer called the Auro-Matic is used to output Surround Sound.



MPEG-H sound mode

Sound mode type	Description
MPEG-H	This mode can be selected when MPEG-H audio is being delivered, such as in TV broadcasts. With MPEG-H, you can enjoy playback of highly realistic sound according to the format it is delivered in, such as music programs with high-quality sound and movies with multi-channel audio.

PCM multi-channel sound mode

Sound mode type	Description
Multi Ch In	This mode can be selected when playing multi-channel PCM/DSD sources.

Original sound mode

Sound mode type	Description
Multi Ch Stereo	This mode is for enjoying stereo sound from all speakers.
Rock Arena	This mode simulates the expansive sound of a live concert in an arena.
Jazz Club	This mode simulates the experience of being in an intimate jazz club.
Mono Movie	This mode works with monaural audio sources and delivers a surround sound effect. For optimum channel balance and surround sound effects, connect the monaural source to both of the front (L/R) audio inputs.
Video Game	This mode provides an exciting, dynamic surround sound effect with your favorite action video games.
Matrix	This mode adds a spacious surround sound effect with stereo music sources.
Virtual	This mode lets you experience an expansive surround sound effect when playing back through just the front (L/R) speakers only, and when listening with stereo headphones.



Auto sound mode

Sound mode type	Description
Auto	In this mode, the type of digital signal input, such as Dolby Digital, Dolby TrueHD, Dolby Digital Plus, Dolby Digital EX, Dolby Atmos, DTS, DTS-HD, DTS:X, DTS-ES, PCM (multi-channel) is detected, and the playback mode switches automatically to the corresponding mode. If the input signal is analog or PCM (2-channel), stereo playback is used. For Dolby Digital or DTS, the music is played back according to the respective channel number.

Stereo sound mode

Sound mode type	Description
Stereo	This mode plays 2-channel stereo audio with no additional surround sound processing. <ul style="list-style-type: none"> • Sound is output from the front left and right speakers, and subwoofer if connected. • When multi-channel signals are inputted, they are mixed down to 2-channel audio and are played back with no additional surround sound processing.

Direct sound mode

Sound mode type	Description
Direct	This mode plays back audio as recorded in the source.
Pure Direct	This mode plays back an even higher quality sound than the “Direct” mode. The following circuits are stopped in order to further improve sound quality. <ul style="list-style-type: none"> • Display indicator circuit of the main body (display will go off.)



Sound mode that can be selected for each input signal

- The following sound modes can be selected using the MOVIE, MUSIC and GAME buttons.
- Adjust the sound field effect with the menu “Surround Parameter” to enjoy surround sound the way you like it. (👉 p. 171)

Input signal	Sound mode	MOVIE button	MUSIC button	GAME button
2-channel *1	Stereo	<input type="radio"/>	<input type="radio"/>	<input type="radio"/>
	Dolby Surround *2*3	<input type="radio"/>	<input type="radio"/>	<input type="radio"/>
	DTS Neural:X *2*3	<input type="radio"/>	<input type="radio"/>	<input type="radio"/>
	DTS Virtual:X *2*4*5	<input type="radio"/>	<input type="radio"/>	<input type="radio"/>
	Auro-3D *2*6	<input type="radio"/>	<input type="radio"/>	<input type="radio"/>
	Auro-2D Surround *2*7	<input type="radio"/>	<input type="radio"/>	<input type="radio"/>
	Multi Ch Stereo	<input type="radio"/>	<input type="radio"/>	<input type="radio"/>
	Mono Movie	<input type="radio"/>		
	Rock Arena		<input type="radio"/>	
	Jazz Club		<input type="radio"/>	
	Matrix		<input type="radio"/>	
	Video Game			<input type="radio"/>
	Virtual	<input type="radio"/>	<input type="radio"/>	<input type="radio"/>

*1 2-channel also includes analog input.

*2 It cannot be selected when headphones are used.

*3 It cannot be selected when the speaker configuration is front speakers only.

*4 It cannot be selected when a speaker configuration with any height speakers is used.

*5 It cannot be selected when the input signal is Dolby Digital, Dolby Digital Plus, Dolby TrueHD or Dolby Atmos.

*6 It cannot be selected when a speaker configuration without front height or front Dolby Atmos Enabled speakers is used.

*7 It cannot be selected when only front speakers are used.



Input signal	Sound mode	MOVIE button	MUSIC button	GAME button
Multi-channel *8	Stereo	<input type="radio"/>	<input type="radio"/>	<input type="radio"/>
	Dolby Digital	Dolby Digital	<input type="radio"/>	<input type="radio"/>
		Dolby Digital + Dolby Surround *2	<input type="radio"/>	<input type="radio"/>
Dolby Digital + Neural:X *2		<input type="radio"/>	<input type="radio"/>	
Dolby Digital Plus	Dolby Digital Plus	<input type="radio"/>	<input type="radio"/>	<input type="radio"/>
	Dolby Digital Plus + Dolby Surround *2 *9	<input type="radio"/>	<input type="radio"/>	<input type="radio"/>
	Dolby Digital Plus + Neural:X *2	<input type="radio"/>	<input type="radio"/>	<input type="radio"/>
	Dolby Atmos *2 *10	<input type="radio"/>	<input type="radio"/>	<input type="radio"/>
Dolby TrueHD	Dolby TrueHD	<input type="radio"/>	<input type="radio"/>	<input type="radio"/>
	Dolby TrueHD + Dolby Surround *2 *9	<input type="radio"/>	<input type="radio"/>	<input type="radio"/>
	Dolby TrueHD + Neural:X *2	<input type="radio"/>	<input type="radio"/>	<input type="radio"/>
	Dolby Atmos *2 *10	<input type="radio"/>	<input type="radio"/>	<input type="radio"/>
Dolby Atmos	Dolby Atmos	<input type="radio"/>	<input type="radio"/>	<input type="radio"/>

*2 It cannot be selected when headphones are used.

*8 The sound mode that can be selected differs depending on the audio format of the input signal and the number of channels.

*9 This can be selected when the input signal does not contain Dolby Atmos.

*10 This can be selected when the input signal contains Dolby Atmos.



Input signal		Sound mode	MOVIE button	MUSIC button	GAME button
Multi-channel *8	DTS	DTS Surround	<input type="radio"/>	<input type="radio"/>	<input type="radio"/>
		DTS + Dolby Surround	<input type="radio"/>	<input type="radio"/>	<input type="radio"/>
		DTS + Neural:X	<input type="radio"/>	<input type="radio"/>	<input type="radio"/>
		DTS + Virtual:X	<input type="radio"/>	<input type="radio"/>	<input type="radio"/>
	DTS-HD	DTS-HD	<input type="radio"/>	<input type="radio"/>	<input type="radio"/>
		DTS-HD + Dolby Surround *2	<input type="radio"/>	<input type="radio"/>	<input type="radio"/>
		DTS-HD + Neural:X *2	<input type="radio"/>	<input type="radio"/>	<input type="radio"/>
		DTS-HD + Virtual:X *2 *4	<input type="radio"/>	<input type="radio"/>	<input type="radio"/>
	DTS:X	DTS:X	<input type="radio"/>	<input type="radio"/>	<input type="radio"/>
		DTS:X + Virtual:X *2 *4	<input type="radio"/>	<input type="radio"/>	<input type="radio"/>
	IMAX DTS	IMAX DTS *2 *11	<input type="radio"/>	<input type="radio"/>	<input type="radio"/>
		IMAX DTS + Neural:X *2 *11	<input type="radio"/>	<input type="radio"/>	<input type="radio"/>
		IMAX DTS + Virtual:X *2 *11	<input type="radio"/>	<input type="radio"/>	<input type="radio"/>
	IMAX DTS:X	IMAX DTS:X *2 *11	<input type="radio"/>	<input type="radio"/>	<input type="radio"/>
		IMAX DTS:X + Virtual:X *2 *4 *11	<input type="radio"/>	<input type="radio"/>	<input type="radio"/>

*2 It cannot be selected when headphones are used.

*4 It cannot be selected when a speaker configuration with any height speakers is used.

*8 The sound mode that can be selected differs depending on the audio format of the input signal and the number of channels.

*11 Selectable when "Surround Parameter" - "IMAX" is set to "Auto" in the menu. When "IMAX" is set to "Off", playback is normal DTS or DTS:X. (📖 p. 174)



Input signal	Sound mode	MOVIE button	MUSIC button	GAME button
PCM multi-channel	Multi Ch In	<input type="radio"/>	<input type="radio"/>	<input type="radio"/>
	Multi Ch In 7.1 *2	<input type="radio"/>	<input type="radio"/>	<input type="radio"/>
	Multi In + Dolby Surround *2	<input type="radio"/>	<input type="radio"/>	<input type="radio"/>
	Multi Ch In + Neural:X *2	<input type="radio"/>	<input type="radio"/>	<input type="radio"/>
	Multi In + Virtual:X *2 *4	<input type="radio"/>	<input type="radio"/>	<input type="radio"/>
MPEG-H	MPEG-H	<input type="radio"/>	<input type="radio"/>	<input type="radio"/>
Multi-channel *8	Auro-3D *2 *6 *12	<input type="radio"/>	<input type="radio"/>	<input type="radio"/>
	Auro-2D Surround *2 *7 *12	<input type="radio"/>	<input type="radio"/>	<input type="radio"/>
	Multi Ch Stereo	<input type="radio"/>	<input type="radio"/>	<input type="radio"/>
	Mono Movie *13	<input type="radio"/>		
	Rock Arena *13		<input type="radio"/>	
	Jazz Club *13		<input type="radio"/>	
	Matrix *13		<input type="radio"/>	
	Video Game *13			<input type="radio"/>
	Virtual *13	<input type="radio"/>	<input type="radio"/>	<input type="radio"/>

*2 It cannot be selected when headphones are used.

*6 It cannot be selected when a speaker configuration without front height or front Dolby Atmos Enabled speakers is used.

*7 It cannot be selected when only front speakers are used.

*8 The sound mode that can be selected differs depending on the audio format of the input signal and the number of channels.

*12 It cannot be selected when the input signal is Dolby Atmos, DTS:X and MPEG-H.

*13 It cannot be selected when the input signal is MPEG-H.



■ Views on the display

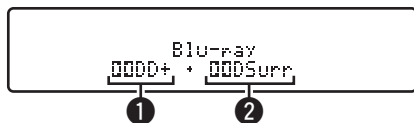

① Shows a decoder to be used.

- In the case of the Dolby Digital Plus decoder, “Dolby Digital Plus” is displayed.

② Shows a decoder that creates sound output.

- “Dolby Surround” indicates that the Dolby Surround decoder is being used.



HDMI Control function

A recent addition to the HDMI standard is CEC (Consumer Electronics Control), which allows control signals from one device to communicate with another device via the HDMI cable connection.

Setting procedure

1 Enable the HDMI Control function of this unit.

Set "HDMI Control" to "On". (☞ p. 188)

2 Turn the power on for all the devices connected by HDMI cable.

3 Set the HDMI Control function for all devices connected by HDMI cable.

- Please consult the operating instructions for the connected devices to check the settings.
- Carry out steps 2 and 3 should any of the devices be unplugged.

4 Switch the television input to the HDMI input connected to this unit.

5 Switch the input source of this unit to check that video from the player connected by HDMI is played back correctly.

6 When you turn the TV's power to standby, check that the power of this unit also goes to standby.

NOTE

- Some functions may not operate depending on the connected TV or player. Check the owner's manual of each device for details beforehand.
- The HDMI ZONE2 function is not compatible with the HDMI Control function.
- When the HDMI ZONE2 function is used with "HDMI Control" in the menu set to "On", the HDMI ZONE2 function may not fully work.



Sleep timer function

You can have the power automatically switched to standby once a set time has elapsed. This is convenient for viewing and listening while going to sleep. The sleep timer function can be set for each zone.

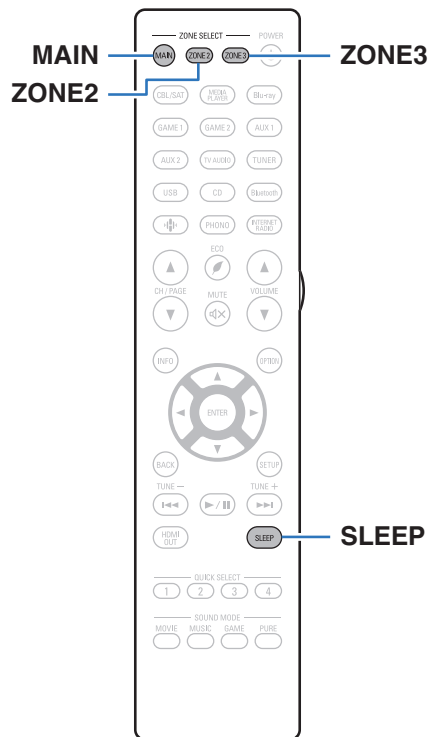

Using the sleep timer

- 1 Press MAIN, ZONE2 or ZONE3 to select the operating zone with the remote control.**

The button for the selected zone is lit.
- 2 Press SLEEP and display the time you want to set.**
 - The **S** indicator lights up on the display and the sleep timer starts.
 - You can set the sleep timer in the range from 10 to 120 minutes in steps of 10 minutes.

■ Checking the remaining time

Press SLEEP when the sleep timer is in operation.
The remaining time appears on the display.

■ To cancel the sleep timer

Press SLEEP to select “Off”.
The **S** indicator on the display turns off.



- The sleep timer setting is canceled when the unit switches to standby mode.

NOTE

- The sleep timer function cannot turn off the power of devices connected to this unit. To turn off the power of those connected devices, set up sleep timers on the connected devices themselves.



Quick select plus function

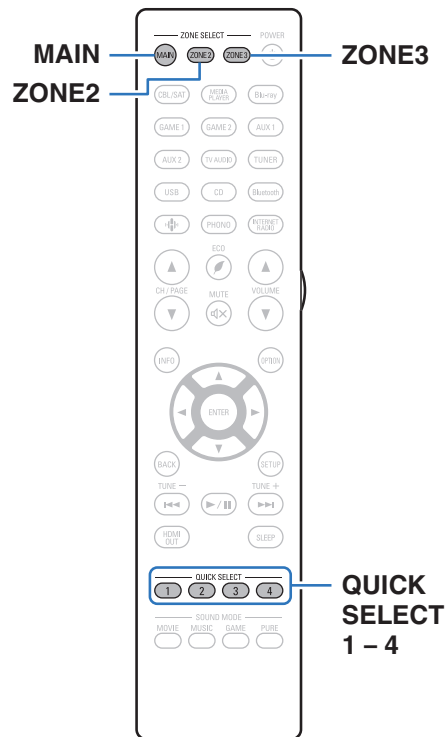

Settings such as the input source, volume level and sound mode can be registered to the QUICK SELECT 1 - 4 buttons.

You can simply press one of the registered QUICK SELECT buttons in subsequent playbacks to switch to the group of saved settings in a batch. By saving frequently used settings at the QUICK SELECT 1 – 4 buttons, you will always be able to easily call up the same playback environment. The Quick Select Plus function can be memorized for each zone.



- The QUICK SELECT button on main unit can only be used to operate the MAIN ZONE.



Calling up the settings

1 Press MAIN, Z2 or Z3 to select the operating zone with the remote control.

The button for the selected zone is lit.

2 Press QUICK SELECT.

The Quick Select settings registered to the button you pressed are called up.

- The default settings for the input source are as shown below.

[MAIN ZONE] / [ZONE2] / [ZONE3]

Button	Input source
QUICK SELECT 1	CBL/SAT
QUICK SELECT 2	Blu-ray
QUICK SELECT 3	Media Player
QUICK SELECT 4	HEOS Music



- Volume is not registered to Quick Select Plus in the factory default settings. See “Changing the settings” to register volume to Quick Select Plus. (🔗 p. 146)



Changing the settings

1 Set the items below to the settings you want to register.

The following settings from ① to ⑾ can be memorized for MAIN ZONE, and settings ① and ② can be memorized for ZONE2 and ZONE3.

- ① Input source (🔑 p. 85)
- ② Volume (🔑 p. 86)
- ③ Sound mode (🔑 p. 127)
- ④ Audyssey (Audyssey MultEQ® XT32, Audyssey Dynamic EQ®, Audyssey Dynamic Volume®, Audyssey LFC™) (🔑 p. 181)
- ⑤ “Restorer” (🔑 p. 179)
- ⑥ “Adjusting the volume of each channel to match the input source (Channel Level Adjust)” (🔑 p. 120)
- ⑦ “Displaying your desired video during audio playback (Video Select)” (🔑 p. 124)
- ⑧ “All Zone Stereo” (🔑 p. 125)
- ⑨ “Speaker Preset” (🔑 p. 126)
- ⑩ “HDMI Video Output” (🔑 p. 191)
- ⑾ “TV Audio sharing settings” (🔑 p. 147)



- Press and hold QUICK SELECT while a radio station is being received is being played back with any of the following sources, the current radio station is memorized.
 - Internet Radio Station / Spotify

2 Press MAIN, ZONE2 or ZONE3 to select the operating zone with the remote control.

The button for the selected zone is lit.

3 Press and hold the desired QUICK SELECT until “Quick* Memory”, “Z2 Quick* Memory” or “Z3 Quick* Memory” appears on the display.

The current settings will be memorized.

* is displayed the number for the QUICK SELECT button you pressed.

■ Changing the Quick Select Name

The MAIN ZONE Quick Select name displayed on the TV screen or display of this unit can be changed to a different name.

For the name change method, see “Quick Select Names”. (🔑 p. 259)



■ TV Audio sharing settings

You can enjoy the same content as the MAIN ZONE in ZONE2 or ZONE3 while maintaining surround playback of the content from TV or other playback devices in the MAIN ZONE with the original audio format such as Dolby Atmos.

By saving the following settings in advance to Quick Select, you can easily call up the playback environments to be used in the MAIN ZONE and ZONE2 or ZONE3 with this function.

- 1 Select the input source to play back in the MAIN ZONE.**
- 2 Press ZONE2 ON/OFF or ZONE3 ON/OFF on the main unit to turn on the power of ZONE2 or ZONE3.**
- 3 Press ZONE2 SOURCE or ZONE3 SOURCE on the main unit to switch the input source of ZONE2 or ZONE3 to “Source”.**

If “Source” is selected as the input source of ZONE2 or ZONE3, the input source is changed to mirror that of the MAIN ZONE.
- 4 Press and hold the desired QUICK SELECT until “Quick Select* Memory” appears on the display.**



Panel lock function

To prevent accidental operation of this unit, you can disable operation of the buttons on the front panel.

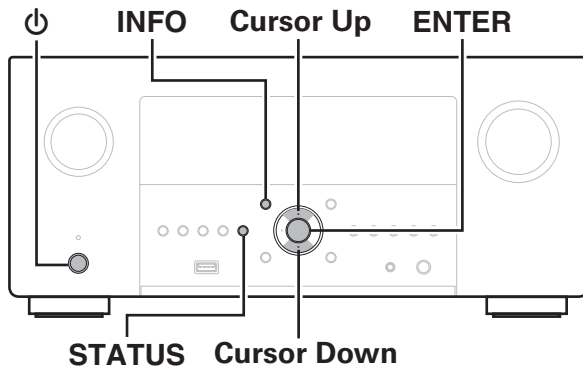

Disabling all key button operations

- 1 Press ϕ while you press and hold STATUS and INFO with the unit in standby mode.
- 2 Use cursor Up/Down to select "FP/VOL LOCK On".
- 3 Press ENTER to enter the setting.
All button operations except ϕ are disabled.

Disabling all button operations except VOLUME

- 1 Press ϕ while you press and hold STATUS and INFO with the unit in standby mode.
- 2 Use cursor Up/Down to select "FP LOCK On".
- 3 Press ENTER to enter the setting.
All button operations except ϕ and VOLUME are disabled.



Canceling the Panel lock function

- 1 Press ϕ while you press and hold STATUS and INFO with the unit in standby mode.**
- 2 Use cursor Up/Down to select “FP LOCK *Off”.**
(* The currently set mode.)
- 3 Press ENTER to enter the setting.**
The Panel lock function is canceled.



- Even when the Panel lock function is set, you can operate the unit using the remote control unit.



Remote lock function

When connecting an IR receiver, enable the Remote lock function. When the function is enabled, you can not perform operations with the remote control unit.

By default, this function is disabled.

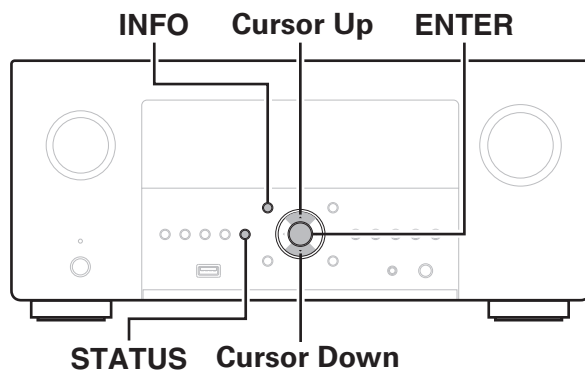

Disabling the sensor function of the remote control unit

- 1** Press **⏻** while you press and hold **STATUS** and **INFO** with the unit in standby mode.
- 2** Use **cursor Up/Down** to select “RC LOCK On”.
- 3** Press **ENTER** to enter the setting.
The infrared light receiving function is disabled.

Enabling the remote sensor function

- 1** Press **⏻** while you press and hold **STATUS** and **INFO** with the unit in standby mode.
- 2** Use **cursor Up/Down** to select “RC LOCK *Off”.
(* The currently set mode.)
- 3** Press **ENTER** to enter the setting.
Infrared light receiving function on the main unit is enabled.



Web control function

You can control and configure this unit from a web control screen on a web browser.

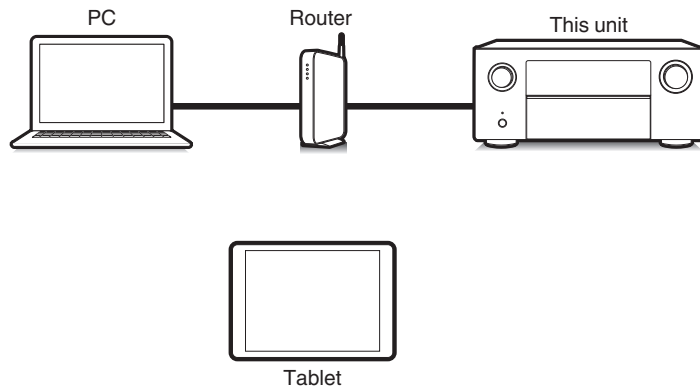

- This unit and the PC or tablet need to be connected correctly to the network in order to use the web control function. (👉 p. 79)
- Depending on the settings of your security-related software, you may not be able to access this unit from your PC. If this is the case, then change the settings of the security-related software.

Controlling the unit from a web control

The web control screen supports the following functions.



- 1 Setup Menu
- 2 Power ON/OFF for each zone
- 3 MAIN ZONE input source switching

Web control screen Top menu



- Audyssey Setup is not supported on the web control screen. If you wish to perform measurement, perform measurement from the on-screen Setup Menu.
- Advanced Setup contains settings for use by custom installers and should not be used at any other time.



- 1 Switch the “Network Control” setting to “Always On”.
( p. 247)
- 2 Check the IP address of this unit with “Information”.
( p. 243)

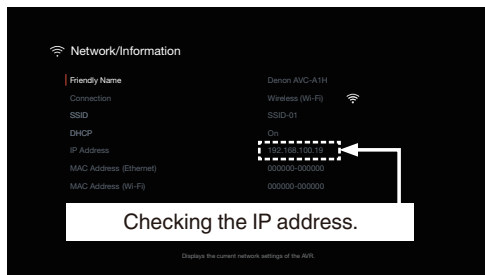

- 3 Open a web browser on a PC or tablet.

- 4 Enter the IP address of this unit in browser's address box.

For example, if the IP address of this unit is “192.168.100.19”, enter “http://192.168.100.19”.

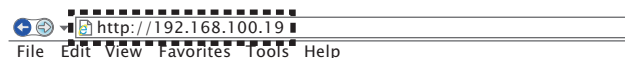

- 5 A privacy error message is displayed when the web control screen is opened through a web browser. Follow the following procedure to proceed to the web control screen.

The message and behavior differ depending on your web browser.



6 When the top menu is displayed on the web browser, click on the menu item you want to operate.

Example (Chrome):

Click “Advanced” and “Proceed to xxx.xxx.xxx.xxx (IP address)” to open the web control screen.

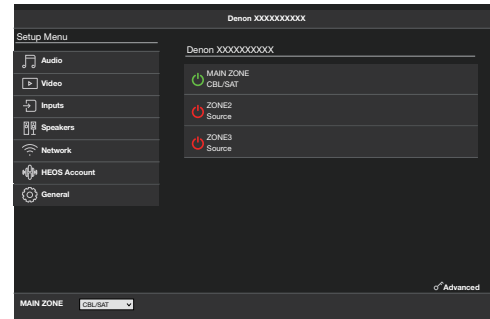
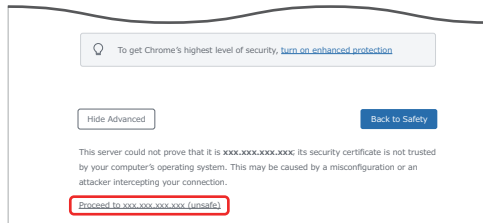
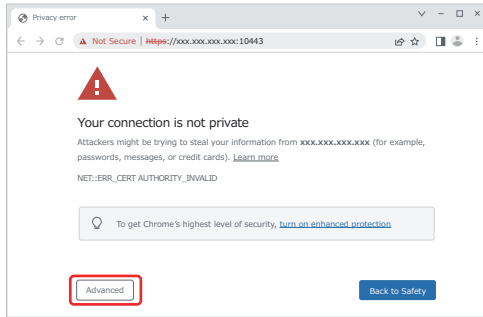

Playback in ZONE2/ZONE3 (Another room)

You can operate this unit to enjoy video and audio in a room (ZONE2 and ZONE3) that is different from the room where this unit is placed (MAIN ZONE).

- You can simultaneously play back the same source in both the MAIN ZONE, ZONE2 and ZONE3.
- You can also play back separate sources in the MAIN ZONE, ZONE2 and ZONE3.

■ Connecting ZONE (👉 p. 155)

“Connection 1 : Connection through the HDMI ZONE2 connector” (👉 p. 155)

“Connection 2 : Connection using a speaker output terminal” (👉 p. 156)

“Connection 3 : Connection through the external power amplifiers” (👉 p. 158)

■ Playback the source in ZONE2/ZONE3 (👉 p. 159)

“Playing the same source simultaneously in MAIN ZONE, ZONE2 and ZONE3 (TV Audio Sharing setting)” (👉 p. 159)

“Playing different sources in MAIN ZONE, ZONE2 and ZONE3” (👉 p. 161)

■ Adjusting the Volume in ZONE2/ZONE3 (👉 p. 163)

“Adjusting the volume” (👉 p. 163)

“Turning off the sound temporarily (Muting)” (👉 p. 163)



Connecting ZONE

■ Connection 1 : Connection through the HDMI ZONE2 connector

When a TV is connected to the HDMI ZONE2 OUT connector, you can play back a video or audio from the device connected to the HDMI 1 – 7 IN connector in ZONE2 (HDMI ZONE2 function).

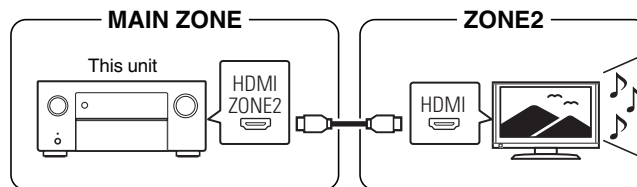

- When a TV is connected to the HDMI ZONE2 OUT connector, and the MAIN ZONE and ZONE2 are set to the same input source, the MAIN ZONE audio may be mixed down to 2-channel audio.



■ Connection 2 : Connection using a speaker output terminal

When “Assign Mode” in the menu is set to any of the following audio is output from speakers in ZONE2 or ZONE3. (👉 p. 213)

□ Assign Mode: 13.1ch + ZONE2

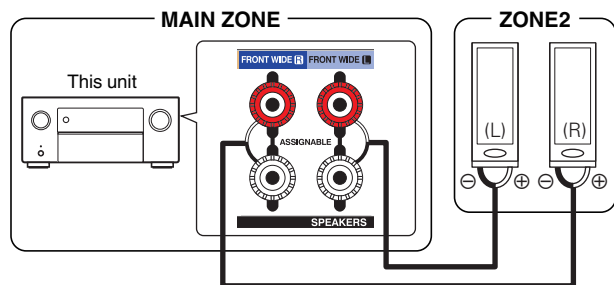

□ Assign Mode: 13.1ch + ZONE3

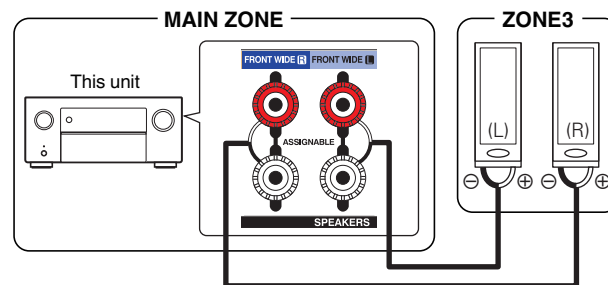

Assign Mode: 13.1ch + ZONE2/3-MONO

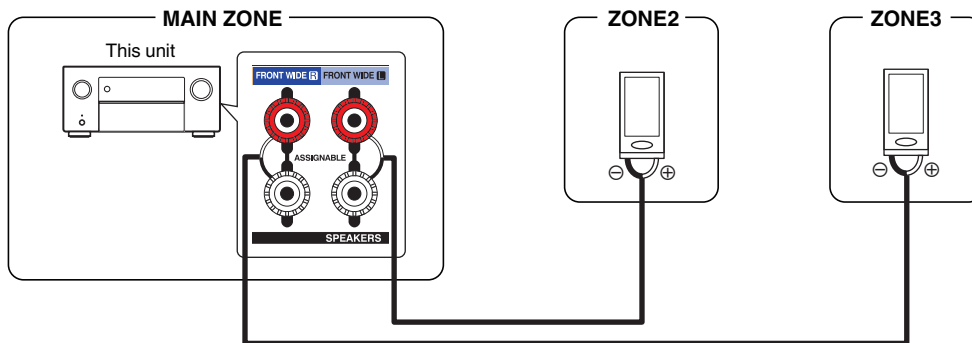

■ Connection 3 : Connection through the external power amplifiers

The audio signals of this unit's ZONE2 and ZONE3 audio output connectors are played on the ZONE2 and ZONE3 power amplifiers.

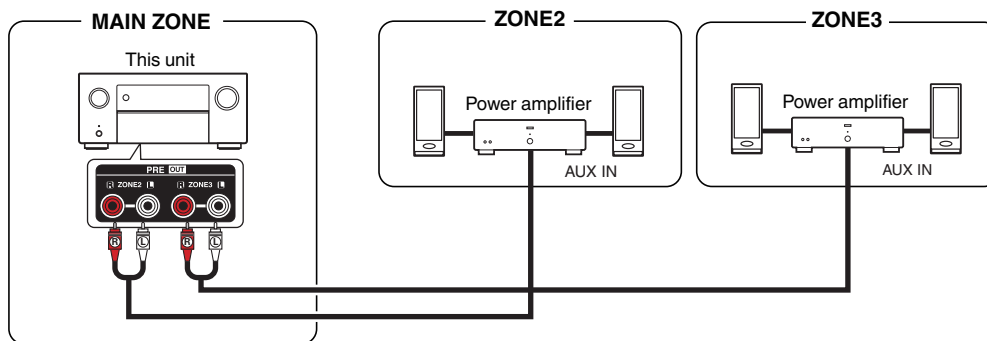

Playback the source in ZONE2/ZONE3

■ Playing the same source simultaneously in MAIN ZONE, ZONE2 and ZONE3 (TV Audio Sharing setting)

The TV Audio Sharing setting of this unit can be used to output all signals from ZONE2 and ZONE3 by setting “Source” as the input source for ZONE2 and ZONE3. When playing audio input from a TV via the ARC or eARC or audio input from a playback device, you can enjoy the original input audio format, such as Dolby Atmos, in surround sound in MAIN ZONE while playing the same content in ZONE2 and ZONE3.



- Only the controls on the main unit can be used to set “Source” as the input source.

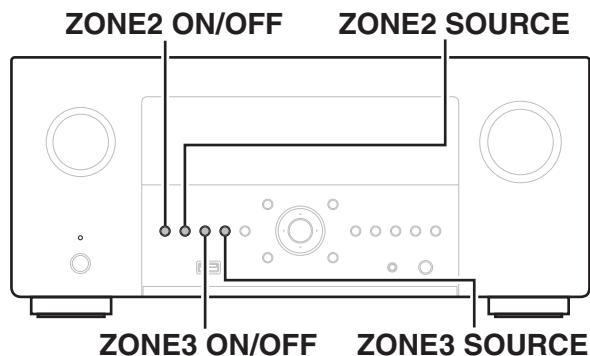

1 Select the input source to play back in the MAIN ZONE.

2 Press ZONE2 ON/OFF or ZONE3 ON/OFF on the main unit to turn on the power of ZONE2 or ZONE3.

The **MULTI ZONE** indicator on the display lights.



3 Press ZONE2 SOURCE or ZONE3 SOURCE on the main unit to switch the input source of ZONE2 or ZONE3 to “Source”.

If “Source” is selected as the input source of ZONE2 or ZONE3, the input source is changed to mirror that of the MAIN ZONE. “Source” is the default setting.

- The following audio signals can be played in ZONE2 and ZONE3.

Input	Output	
	ZONE2	ZONE3
Digital Audio (HDMI)	<input type="radio"/>	<input type="radio"/>
Digital Audio (Coaxial/Optical)	<input type="radio"/>	<input type="radio"/>
Analog Audio	<input type="radio"/>	<input type="radio"/>
USB	<input type="radio"/>	<input type="radio"/>
HEOS Music	<input type="radio"/>	<input type="radio"/>



■ Playing different sources in MAIN ZONE, ZONE2 and ZONE3

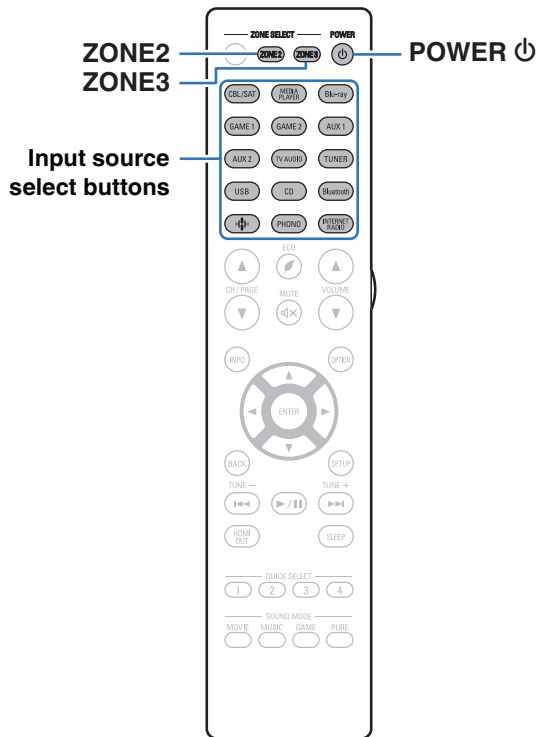

1 Press ZONE2 or ZONE3 to select the operating zone with the remote control.

The button for the selected zone is lit.

2 Press POWER to turn on the ZONE2 or ZONE3 power.

The **MULTI ZONE** indicator on the display lights.

- Power in ZONE2 or ZONE3 can be turned on or off by pressing ZONE2 ON/OFF or ZONE3 ON/OFF on the main unit.



3 Press the input source select button to select the input source to be played.

The audio signal of the selected source is output to ZONE2 or ZONE3.

- To perform an operation with the main unit, press ZONE2 SOURCE or ZONE3 SOURCE. Each time you press ZONE2 SOURCE or ZONE3 SOURCE, the input source changes.
- The following audio signals can be played in ZONE2 and ZONE3.

Input	Output	
	ZONE2	ZONE3
Digital Audio (HDMI)	<input type="radio"/> *1	
Digital Audio (Coaxial/Optical)	<input type="radio"/> *2	<input type="radio"/> *2
Analog Audio	<input type="radio"/>	<input type="radio"/>
USB	<input type="radio"/>	<input type="radio"/>
HEOS Music	<input type="radio"/>	<input type="radio"/>

*1 To play an HDMI signal other than PCM 2-channel in ZONE2, set "HDMI Audio" to "PCM". (🔗 p. 258)

*2 Only a 2-channel PCM signal is supported.



Adjusting the Volume in ZONE2/ZONE3

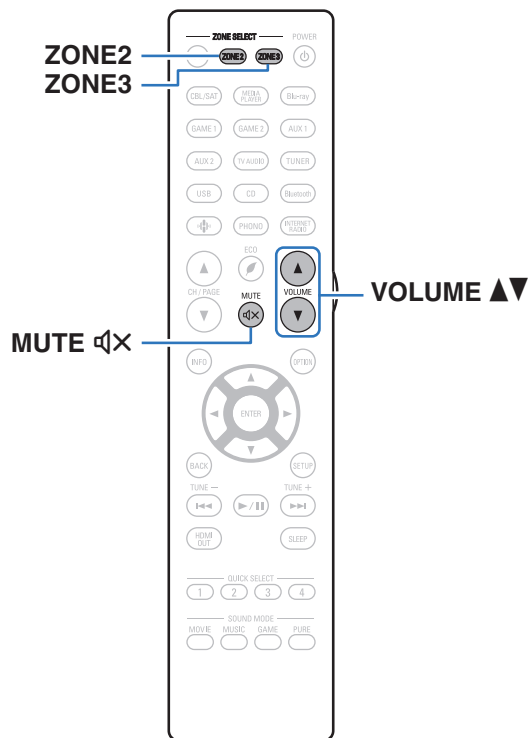

■ Adjusting the volume

1 Press ZONE2 or ZONE3 to select the operating zone with the remote control.

The button for the selected zone is lit.

2 Use VOLUME ▲▼ to adjust the volume.

- At time of purchase, “Volume Limit” is set to “70 (-10 dB)”.
(☞ p. 258)



- Turn MASTER VOLUME after pressing ZONE2 SOURCE or ZONE3 SOURCE on the main unit to adjust the volume.

■ Turning off the sound temporarily (Muting)

1 Press ZONE2 or ZONE3 to select the operating zone with the remote control.

The button for the selected zone is lit.

2 Press MUTE .

The sound is reduced to the level set at “Mute Level” in the menu.
(☞ p. 259)



- To cancel mute, either adjust the sound volume or press MUTE  again.





Menu map

When using menu operations, connect this unit to a TV and operate this unit while viewing the TV.

The recommended settings are configured for this unit by default. You can customize this unit based on your existing system and your preferences.

Setting items	Detailed items	Description	Page
 Audio	Subwoofer Level Adjust	Adjusts the subwoofer channel volume for all input sources.	170
	Bass Sync	Synchronizes the timing of the low frequency sound.	170
	Surround Parameter	Adjusts surround sound parameters.	171
	Restorer	Expands the low and high frequency components of compressed audio content such as MP3 files to enable richer audio playback.	179
	Volume	Sets the MAIN ZONE (room where the unit is located) volume setting.	180
	Audyssey	Makes Audyssey MultEQ® XT32, Audyssey Dynamic EQ®, Audyssey Dynamic Volume® and Audyssey LFC™ settings.	181
	Graphic EQ	Adjusts the tonal quality for each speaker using a graphic equalizer.	184
 Video	HDMI Setup	Makes settings for HDMI Audio Out, HDMI Pass Through and HDMI Control settings.	186
	Output Settings	Makes settings for video output.	191
	On-Screen Display	Selects the on-screen display user interface preferences.	193
	Screensaver	Sets the screen saver setting.	194
	4K/8K Signal Format	Sets signal format options for your 4K or 8K video equipment.	194
	HDCP Setup	Sets the HDCP version for each HDMI input source.	196
	TV Format	Selects the format used to send video to the TV.	196

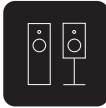

Setting items	Detailed items	Description	Page
 Inputs	Input Assign	Changes input connector assignment and the audio input mode.	197
	Source Rename	Changes the display name for input source.	200
	Hide Sources	Selects source inputs to hide on the user interface and front panel displays.	200
	Source Level	Adjusts the input level for the current source.	201
 Speakers	Audyssey® Setup	The acoustic characteristics of the connected speakers and listening room are measured and the optimum settings are made automatically.	202
	Manual Setup	Sets up the speakers manually or changes Audyssey® Setup settings.	213
 Network	Information	Displays network information.	243
	Connection	Configures the network connection.	243
	Settings	Configures the network settings (DHCP and IP address).	246
	Network Control	Enables network communication in standby power mode.	247
	Friendly Name	Edits the name of this unit that is displayed on the network.	248
	Diagnostics	Tests the network connection.	248
	AirPlay	Settings for Apple AirPlay.	249
	Spotify Connect	Toggles access to Spotify Connect.	250
	Wi-Fi and Bluetooth	Toggles power to the Wi-Fi and Bluetooth radios.	250



Setting items	Detailed items	Description	Page
 HEOS Account	[When the user is signed out of the HEOS account]		
	I have a HEOS Account	Select to sign in.	251
	Create Account	Creates new HEOS account.	251
	Forgot Password	If you forgot your password, we'll send you an email with instructions to reset it.	251
	[When the user is signed in to the HEOS account]		
	Signed in as	Displays your HEOS account.	251
	Change Location	Selects your location.	251
	Change Password	Changes your HEOS account password.	251
	Delete Account	Deletes your HEOS account.	251
	Sign Out	Signs out of your HEOS account.	251



Setting items	Detailed items	Description	Page
 General	Language	Selects the language for the on-screen user interface.	252
	Owner's Manual	Access the online Owner's Manual from your mobile device.	252
	ECO	Configures the ECO Mode and Auto Standby energy-saving functions.	252
	Bluetooth Transmitter	Sets Bluetooth transmitter settings.	256
	ZONE2 Setup/ ZONE3 Setup	Makes settings for audio playback with ZONE2 and ZONE3.	257
	Zone Rename	Changes the display title of each zone to one you prefer.	259
	Quick Select Names	Changes the Quick Select Name display title to one you prefer.	259
	Trigger Out 1/ Trigger Out 2	Select the conditions for activating trigger out function.	260
	Front Display	Makes settings related to the display on this unit.	260
	Firmware	Checks for the latest firmware information about updates, updates the firmware.	261
	Information	Shows information about this unit settings, input signals, etc.	263
	Usage Data	Selects whether or not to send anonymous usage data to Denon.	265
	Save & Load	Save and restore device settings by using a USB memory device.	266
	Setup Lock	Protects settings from inadvertent changes.	266
Reset	Various settings are reset to the factory default values.	267	



Setting items	Detailed items	Description	Page
 Setup Assistant	Begin Setup...	Performs basic installation/connections/settings from the beginning according to the guidance indicated on the TV screen.	Page 9 of the separate manual "Quick Start Guide"
	Language Select	Sets individual setting items according to the guidance displayed on the TV screen.	
	Speaker Setup		
	Speaker Calibration		
	Network Setup		
	TV Audio Setup		
	Input Setup		
	Mobile Apps		



Menu operations

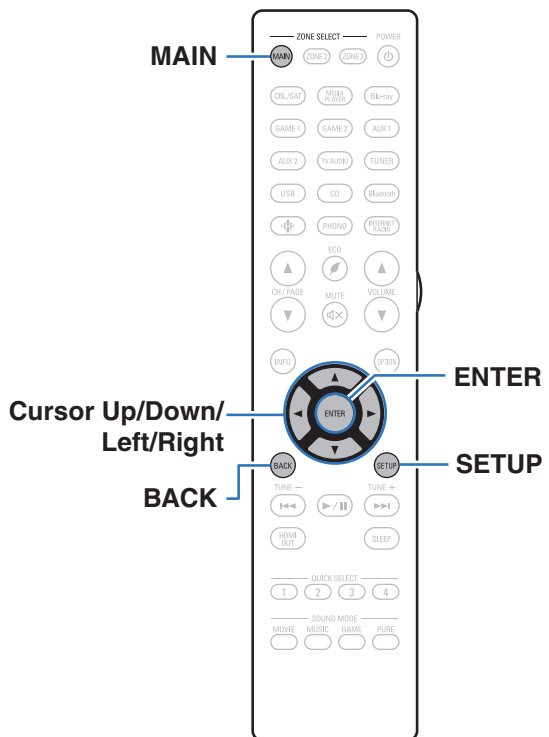

- 1 Press MAIN on the remote control unit to set the operating zone to the MAIN ZONE.**
The MAIN button lights.
- 2 Press SETUP.**
The menu is displayed on the TV screen.
- 3 Use cursor Up/Down/Right to select the menu to be set or operated, then press ENTER.**
- 4 Use cursor Left/Right to change to desired setting.**
- 5 Press ENTER to enter the setting.**
 - To return to the previous item, press BACK.
 - Exiting the menu, press SETUP while the menu is displayed. The menu display disappears.



Audio

Make audio-related settings.

Subwoofer Level Adjust

Adjusts the subwoofer channel volume for all input sources.

■ Subwoofer 1 / Subwoofer 2 / Subwoofer 3 / Subwoofer 4

Adjusts the volume level for the Subwoofer 1, 2, 3 and 4.

-12.0 dB – +12.0 dB (Default: 0.0 dB)



- This setting is also reflected in the subwoofer channel level in the “Speakers” - “Levels” menu settings. (🔗 p. 235)
- The name of the subwoofer changes depending on the configuration of “Subwoofer Mode” (🔗 p. 226) and “Subwoofer Layout” (🔗 p. 226).

Bass Sync

For contents recorded in multi-channel such as Blu-ray discs, the recorded low frequency effects (LFE) may be out of synch and delayed. This function corrects such a delay of low frequency effects (LFE).

0 ms – 16 ms (Default : 0 ms)



- How low frequency effects (LFE) are delayed differ according to the disc. Set this to the desired value.
- “Bass Sync” settings are stored for each input source.
- This can be set when the LFE signal is included in the input signal.



Surround Parameter

You can adjust the surround audio sound field effects to match your preferences.

The items (parameters) that can be adjusted depend on the signal being input and the currently set sound mode.



- Some setting items cannot be set while playback is stopped. Make the settings during playback.
- “Surround Parameter” settings are stored for each sound mode.

■ Cinema EQ

Gently softens the upper treble range of movie soundtracks to reduce possible harshness and improve clarity.

On: “Cinema EQ” is used.

Off
(Default): “Cinema EQ” is not used.



- This item cannot be set when sound mode is “Direct”, “Pure Direct”, “Stereo” and “Original sound mode”.

■ Loudness Management

This sets whether to output as specified in “Dynamic Compression” or output directly without compressing the dynamic range of audio recorded in the disc.

On
(Default):

Outputs are given based on enabling the settings made in “Dynamic Compression” and Dialogue normalization function.

Off:

“Dynamic Compression” settings and Dialogue normalization are disabled, and the signals on the disc are output as is.



- “Loudness Management” can be set when Dolby Digital, Dolby Digital Plus, Dolby TrueHD and Dolby Atmos signal is input.



■ Dynamic Compression

Compress dynamic range (difference between loud and soft sounds).

Auto:	Automatic dynamic range compression on/off control according to source.
Low / Medium / High:	These set the compression level.
Off (Default):	Dynamic range compression is always off.



- “Dynamic Compression” can be set when Dolby Digital, Dolby Digital Plus, Dolby TrueHD, Dolby Atmos or DTS signal is input.
- “Auto” cannot be set when inputting a DTS signal.

■ Dialog Control

Adjust the volume of dialog in movies, vocals in music, etc. so these can be heard more easily.

0 – 6 (Default : 0)



- This can be set when a DTS:X signal that is compatible with the Dialog Control function is input.

■ Low Frequency Effects

Adjust the low frequency effects level (LFE).

-10 dB – 0 dB (Default: 0 dB)



- This can be set when the LFE signal is included in the input signal.
- This item can be selected when a Dolby Digital or DTS signal or DVD-Audio is played.
- For proper playback of the different sources, we recommend setting to the values below.
 - Dolby Digital sources: 0 dB
 - DTS movie sources: 0 dB
 - DTS music sources: -10 dB



■ Speaker Virtualizer

The Speaker Virtualizer enhances the surround and height speaker channels to create an enveloping virtual surround effect.

On
(Default): Enables "Speaker Virtualizer".

Off: Disables "Speaker Virtualizer".



- You can set this when the sound mode is "Dolby Atmos", "Dolby Surround" or sound mode that has "+Dolby Surround" in the sound mode name.
- Usable when not using height, ceiling or Dolby Atmos Enabled speakers, or when not using surround speakers.
- Audio is not output from the surround back speaker if "Speaker Virtualizer" is set to "On" when "Speaker Configuration" - "Surround Back" is set to "1 spkr" in the menu.
- Audio is not output from the front wide speaker if "Speaker Virtualizer" is set to "On".

■ Center Spread

Center Spread expands the center channel signal to left and right front speakers to create a wider frontal audio image for the listener. It is optimized and designed primary for playback of stereo music content.

On: Use "Center Spread".

Off
(Default): Do not use "Center Spread".



- You can set this when sound mode is "Dolby Surround".



■ DTS Neural:X

DTS Neural:X Expands the non-object based audio signals and optimizes them for your speaker configuration.

On (Default):	Use “DTS Neural:X”.
Off:	Do not use “DTS Neural:X”.



- You can set this when sound mode is “DTS:X”.

■ IMAX

Sets the audio mode for IMAX playback.

Auto (Default):	Automatically enables IMAX mode when IMAX content is detected.
Off:	Disables IMAX mode.



- This setting cannot be set when headphones are used.

■ IMAX Audio Settings

You can configure special IMAX audio settings to recreate the conditions of an IMAX theater.

Auto (Default):	Applies the optimized speaker settings to reproduce similar to the IMAX theater environment.
---------------------------	----------------------------------------------------------------------------------------------

Manual:	Manually adjusts the “High Pass Filter”, “Low Pass Filter” and “Subwoofer Output”.
----------------	------------------------------------------------------------------------------------



- You can set this when sound mode is “IMAX DTS” or “IMAX DTS:X”.
- “Speakers” - “Crossovers”, “Bass” - “Subwoofer Output” and “LPF for LFE” in the menu cannot be applied during IMAX playback.

■ High Pass Filter

Set the high pass filter cutoff frequency for all speakers during IMAX playback.

40 Hz / 60 Hz / 80 Hz / 90 Hz / 100 Hz / 110 Hz / 120 Hz / 150 Hz / 180 Hz / 200 Hz / 250 Hz (Default: 80 Hz)



- You can set this when “IMAX Audio Settings” is set to “Manual”.



■ Low Pass Filter

Set the low pass filter cutoff frequency of the LFE signal during IMAX playback.

80 Hz / 90 Hz / 100 Hz / 110 Hz / 120 Hz / 150 Hz / 180 Hz / 200 Hz / 250 Hz (Default: 120 Hz)



- You can set this when "IMAX Audio Settings" is set to "Manual".

■ Subwoofer Output

Set the bass signal to be played by the subwoofer during IMAX playback.

LFE + Main:

The low range signal of all speakers is added to the LFE signal output from the subwoofer. The LFE signal and the bass component of each speaker is played.

LFE
(Default):

Only the LFE signal is played.



- You can set this when "IMAX Audio Settings" is set to "Manual".

■ Auro-Matic 3D Preset

Selects the Auro-Matic 3D Preset for fine tuning the Auro-3D experience to specific audio material.

Small:

"Small" is ideal for pop and chamber music.

Medium
(Default):

"Medium" is ideal on jazz music or typical movies and TV shows.

Large:

"Large" is ideal for recordings that were recorded in large spaces (e.g. orchestral recording).

Movie:

"Movie" is ideal for experiencing a large-cinema effect for watching movies (e.g. action movies with big explosions).

Speech:

"Speech" is ideal for recordings which are mostly dialog (e.g. news broadcast), and that have virtually no inherent spatial information.



- You can set this when the sound mode is set to Auro-3D.
- This cannot be set if the input signal contains Auro-3D signals containing a Height channel.



■ Auro-Matic 3D Strength

Changes the level of the up-mixed channels in relation to the original input signal.

The value ranges from 0 (no up-mixing) to 15 (Maximum level, providing maximum effect).

0 - 15 (Default:12)



- You can set this when the sound mode is set to Auro-3D.
- This cannot be set if the input signal contains Auro-3D signals containing a Height channel.

■ Auro-3D Mode

Select how to output sound to all speakers when Auro-3D decoding is active.

Channel Expansion
(Default):

Incoming Auro-3D content is expanded to additional speakers. All speakers configured for Auro-3D will output sound.

Direct:

Incoming Auro-3D content is sent directly to each corresponding channel. No content is sent to additional speakers.



- You can set this when the input signal contains Auro-3D signal and sound mode is set to Auro-3D.



■ Delay Time

Adjust the audio delay time against video to extend the sound field image.

0 ms – 300 ms (Default: 30 ms)



- You can set this when the sound mode is “Matrix”.

■ Effect Level

Adjust the sound effect level of the current sound mode.

1 – 15 (Default: 10)



- This item can be set when sound mode is “Rock Arena”, “Jazz Club”, “Mono Movie” and “Video Game”.
- Set to a lower level if the positioning and sense of phase of the surround signals seems unnatural.

■ Room Size

Determine size of acoustic environment.

Small: Simulate acoustics of a small room.

Medium small: Simulate acoustics of a medium-small room.

Medium (Default): Simulate acoustics of a medium room.

Medium large: Simulate acoustics of a medium-large room.

Large: Simulate acoustics of a large room.



- This item can be set when sound mode is “Rock Arena”, “Jazz Club”, “Mono Movie” and “Video Game”.
- “Room Size” does not indicate the size of the room in which sources are played.



■ Speaker Select

Selects which speakers output sound, depending on the current sound mode.

Floor: Plays back without height speakers.

Floor & Height (Default): Plays back with height speakers.



- This can be set when the sound mode is the original sound mode.

■ Subwoofer

Turn subwoofer output on and off.

On (Default): The subwoofer is used.

Off: The subwoofer is not used.



- You can set this when the sound mode is “Direct” or “Stereo” and in the menu “Subwoofer Output” is set to “LFE + Main”. (👉 p. 236)

■ Set Defaults

The “Surround Parameter” settings are returned to the default settings.



Restorer

Compressed audio formats such as MP3, WMA (Windows Media Audio) and MPEG-4 AAC reduce the amount of data by eliminating signal components that are hard for the human ear to hear. The “Restorer” function generates the signals eliminated upon compression, restoring the sound to conditions near those of the original sound before compression. It also restores the original bass characteristics for a rich and expanded tonal range.

■ Mode

High:	Optimized mode for compressed sources with very weak highs (64 kbps and under).
Medium:	Apply suitable bass and treble boost for all compressed sources (96 kbps and under).
Low:	Optimized mode for compressed sources with normal highs (96 kbps and over).
Off:	Do not use “Restorer”.



- This item can be set with analog signals or PCM signal (Sample Rate = 44.1/48 kHz) is input.
- This item default setting for “HEOS Music” is “Low”. All others are set to “Off”.
- This cannot be set when the sound mode is set to “Direct” or “Pure Direct”.
- “Restorer” settings are stored for each input source.



Volume

Set the MAIN ZONE (room where the unit is located) volume setting.

■ Scale

Set how volume is displayed.

0 - 98
(Default): Display in the range 0 (Min) to 98.

-79.5 dB - 18.0 dB: Display ---dB (Min), in the range -79.5 dB to 18.0 dB.



- “Scale” settings are reflected in all the zones.

■ Limit

Make a setting for maximum volume.

60 - 80 (-20 dB - 0 dB)

Off (Default)



- The dB value is displayed when the “Scale” setting is “-79.5 dB - 18.0 dB”. (ⓘ p. 180)

■ Power On Level

Sets the initial volume level when the power is turned on.

Last
(Default): Sets the power-on level to the last-used volume level.

Mute: Sets the power-on level to mute level.

1 - 98 (-79 dB - 18 dB) : Sets a specific power-on level.



- The dB value is displayed when the “Scale” setting is “-79.5 dB - 18.0 dB”. (ⓘ p. 180)

■ Mute Level

Set the amount of attenuation when mute is on.

Full
(Default): Sets the mute level to full mute (no sound).

-40 dB : Sets the mute level to 40 dB lower than the current volume level.

-20 dB : Sets the mute level to 20 dB lower than the current volume level.



Audyssey®

Set Audyssey MultEQ® XT32, Audyssey Dynamic EQ®, Audyssey Dynamic Volume® and Audyssey LFC™. These can be selected after Audyssey® Setup has been performed.

For additional information on Audyssey technology, please see “Explanation of terms” (🔗 p. 317).



- “MultEQ® XT32”, “Dynamic EQ”, “Reference Level Offset”, “Dynamic Volume”, “Audyssey LFC™” and “Containment Amount” settings are stored for each input source.
- When the sound mode is in the “Direct” or “Pure Direct” mode, “MultEQ® XT32”, “Dynamic EQ”, “Dynamic Volume” and “Audyssey LFC™” settings cannot be configured.
- When the sound mode is in “DTS Virtual:X” or sound mode that have “+Virtual:X” in the sound mode name, “Dynamic EQ”, “Dynamic Volume” and “Audyssey LFC™” settings cannot be configured.
- This item cannot be selected when a DTS:X format with a sampling frequency of over 48 kHz is input.

■ MultEQ® XT32

MultEQ® XT32 compensates for both time and frequency characteristics of the listening area based on Audyssey® Setup measurement results. Selection is done from three types of compensation curves. We recommend the “Reference” setting.

Reference (Default):	Selects the default calibrated setting with a slight roll off at high frequencies. Optimal for movies.
L/R Bypass:	Selects the reference setting, but bypasses MultEQ® XT32 on the front left and right speakers.
Flat:	Selects the calibrated setting which is optimized for small rooms where your listening position is closer to the speakers.
Off:	Do not use “MultEQ® XT32”.



- When using headphones, “MultEQ® XT32” is automatically set to “Off”.



Dynamic EQ

Solves the problem of deteriorating sound quality as volume is decreased by taking into account human perception and room acoustics.

Works with MultEQ® XT32.

On (Default):	Use "Dynamic EQ".
Off:	Do not use "Dynamic EQ".



- When the menu "Dynamic EQ" setting is "On", it is not possible to do "Tone" adjustment. (🔧 p. 121)
- This item cannot be set when "MultEQ® XT32" in the menu is set to "Off".

Reference Level Offset

Audyssey Dynamic EQ® is referenced to the standard film mix level. It makes adjustments to maintain the reference response and surround envelopment when the volume is turned down from 0 dB. However, film reference level is not always used in music or other non-film content. Dynamic EQ Reference Level Offset provides three offsets from the film level reference (5 dB, 10 dB, and 15 dB) that can be selected when the mix level of the content is not within the standard. Recommended setting levels for content are shown below.

0 dB (Film Reference) (Default):	Optimized for content such as movies.
5 dB :	Select this setting for content that has a very wide dynamic range, such as classical music.
10 dB :	Select this setting for jazz or other music that has a wider dynamic range. This setting should also be selected for TV content as that is usually mixed at 10 dB below film reference.
15 dB :	Select this setting for pop/rock music or other program material that is mixed at very high listening levels and has a compressed dynamic range.



- Setting is enabled when "Dynamic EQ" is "On". (🔧 p. 182)



Dynamic Volume

Solves the problem of large variations in volume level between TV, movies and other content (between quiet passages and loud passages, etc.) by automatically adjusting to the user's preferred volume setting.

Works with MultEQ® XT32.

Heavy:	Most adjustment to softest and loudest sounds.
Medium:	Medium adjustment to loudest and softest sound.
Light:	Least adjustment to loudest and softest sounds.
Off (Default):	Do not use "Dynamic Volume".



- If "Dynamic Volume" is set to "Yes" in "Audyssey® Setup", the setting is automatically changed to "Medium". (🔗 p. 202)
- This item cannot be set when "MultEQ® XT32" in the menu is set to "Off".

Audyssey LFC™

Adjusts the low frequency band to prevent bass and vibration from being conveyed to neighboring rooms.

Works with MultEQ® XT32.

On: Use "Audyssey LFC™".

Off
(Default): Do not use "Audyssey LFC™".



- This item cannot be set when "MultEQ® XT32" in the menu is set to "Off".

Containment Amount

Adjusts the amount of low frequency containment. Use higher settings if you have close neighbors.

1 – 7 (Default : 4)



- This can be set when "Audyssey LFC™" in the menu is set to "On".



Graphic EQ

Uses the graphic equalizer to adjust the tone of each speaker.



- Speakers for which “Graphic EQ” can be set differ according to the sound mode.
- This can be set when “MultEQ® XT32” setting is “Off”. (👉 p. 181)
- This cannot be set when the sound mode is set to “Direct” or “Pure Direct”.
- If you are using headphones, you can set the equalizer for headphones. (👉 p. 184)

Graphic EQ / Headphone EQ

Set whether to use the graphic equalizer or not.

On:	Use the graphic equalizer.
Off (Default):	Do not use the graphic equalizer.



- “Headphone EQ” is set in the menu when headphones are used.

Speaker Selection

Select whether to adjust tones for individual speakers or for all speakers.

All:	Adjust all speaker tones together.
Left/Right (Default):	Adjust the left and right speaker tones together.
Each:	Adjust the tone for each speaker.

Adjust EQ

Adjust tonal balance for each frequency band.

1. Select the speaker.
2. Select the adjustment frequency band.
63 Hz / 125 Hz / 250 Hz / 500 Hz / 1 kHz / 2 kHz / 4 kHz / 8 kHz / 16 kHz
3. Adjust the level.
-20.0 dB – +6.0 dB (Default: 0.0 dB)



- Front Dolby, Surround Dolby and Back Dolby speakers can only be set when 63 Hz/125 Hz/250 Hz/500 Hz/1 kHz.



■ Curve Copy

Copy the Flat correction curve created in Audyssey® Setup.



- “Curve Copy” is displayed after Audyssey® Setup has been performed.
- “Curve Copy” cannot be used when using headphones.

■ Set Defaults

The “Graphic EQ” settings are returned to the default settings.



Video

Make video-related settings.

HDMI Setup

Make settings for HDMI Audio Out, HDMI Pass Through and HDMI Control settings.

NOTE

- When "HDMI Pass Through" and "HDMI Control" is set to "On", it consumes more standby power. ("HDMI Pass Through" (🔧 p. 186), "HDMI Control" (🔧 p. 188)) If you are not using this unit for an extended period, it is recommended that you unplug the power cord from the power outlet.

HDMI Audio Out

Selects the audio output speakers.

AVR (Default):	Play back through speakers connected to the unit.
TV:	Play back through TV connected to the unit.



- When the HDMI Control function is activated, priority is given to the TV audio setting. (🔧 p. 141)
- When the power of this unit is on and "HDMI Audio Out" is set to "TV", audio is output as 2-channel from the HDMI OUT connector.

HDMI Pass Through

Selects how this unit will transmit HDMI signals to the HDMI output in standby power mode.

On:	Transmits the selected HDMI input through this unit's HDMI output when this unit is in standby power mode.
Off (Default):	No HDMI signals are transmitted through this unit's HDMI output in standby power mode.



■ Pass Through Source

Selects the HDMI input to pass through the HDMI output when this unit is in standby power mode.

Last
(Default): Selects the last used HDMI input.

CBL/SAT / Media Player / Blu-ray / Game1 / Game2 / AUX1 / AUX2 / TV Audio / CD*: Selects the HDMI input as the standby source.

*“Pass Through Source” can be set when any of the HDMI connectors is assigned to “CD” for the input source in the “Input Assign” setting. (🔧 p. 197)



- “Pass Through Source” can be set when “HDMI Control” is set to “On” or “HDMI Pass Through” is set to “On”. (“HDMI Pass Through” (🔧 p. 186), “HDMI Control” (🔧 p. 188))

■ RC Source Select

Set whether to allow this unit to be turned on by the input source select button on the remote control when this unit is in standby power mode.

Power On + Source
(Default): The power of this unit is turned on and the input source changes.

Source Select Only: This unit remains in standby but switches the HDMI input source when you press an input source button. The power display of this unit blinks when the input source select button of the remote control is pressed.



- “RC Source Select” can be set when “HDMI Control” is set to “On” or “HDMI Pass Through” is set to “On”. (“HDMI Pass Through” (🔧 p. 186), “HDMI Control” (🔧 p. 188))



■ HDMI Control

You can link operations with devices connected to HDMI and compatible with HDMI Control.

On: Use HDMI Control function.

Off
(Default): Do not use HDMI Control function.



- If using the HDMI Control function, connect a TV compatible with HDMI control to the HDMI MONITOR 1 connector.
- Please consult the operating instructions for each connected device to check the settings.
- Refer to “HDMI Control function” for more information about the HDMI Control function. (📖 p. 141)

NOTE

- If the “HDMI Control” settings have been changed, always reset the power to connected devices after the change.

■ ARC

On the TV connected to the HDMI MONITOR 1 connector, set whether to receive sound from the TV via HDMI.

On: Use ARC function.

Off
(Default): Do not use ARC function.



- You can adjust the volume of this unit using the TV remote control.
- If using this function, use a TV compatible with ARC (Audio Return Channel) and enable the HDMI Control function of the TV.
- When “HDMI Control” is set to “On”, the “ARC” settings automatically switch “On”. (📖 p. 188)

NOTE

- If the “ARC” settings have been changed, always reset the power to connected devices after the change.
- Using an eARC function-compatible television enables audio playback from the speaker connected to this unit, regardless of “ARC” settings in the menu.



■ TV Audio Switching

Sets automatic switching to the “TV Audio” input when a TV connected via HDMI sends an appropriate CEC control command to this unit.

On (Default):	Select the “TV Audio” input automatically when receiving a command from the TV.
Off:	Do not select the “TV Audio” input automatically when receiving a command from the TV.



- “TV Audio Switching” can be set when “HDMI Control” is set to “On”.
( p. 188)

■ Power Off Control

Links the power standby of this unit to external devices.

All (Default):	If power to a connected TV is turned off independently of the input source, power to this unit is automatically set to standby.
Video:	With an input source being selected that is assigned “HDMI”, when you turn the power of the TV off, power to this unit is automatically set to standby. ( p. 198)
Off:	This unit does not link with power to a TV.



- “Power Off Control” can be set when “HDMI Control” is set to “On”.
( p. 188)



■ Power Saving

Enables the Power Saving feature of the AVR to reduce energy costs when using the TV's speakers.

This function is activated in the following cases.

- When "TV Audio" is selected as the input source of this unit
- When playing content from a device connected by HDMI

On: Use Power Saving feature.

Off
(Default): Do not use Power Saving feature.



- "Power Saving" can be set when "HDMI Control" is set to "On". (🔗 p. 188)



Output Settings

Makes settings for video output.

■ HDMI Video Output

Select the HDMI monitor connector to be used.

Auto(Dual) (Default):	The presence of a TV connected to the HDMI MONITOR 1 or HDMI MONITOR 2 connector is detected automatically, and that TV connection is used.
Monitor 1:	A TV connected to the HDMI MONITOR 1 connector is always used.
Monitor 2:	A TV connected to the HDMI MONITOR 2 connector is always used.



- If both the HDMI MONITOR 1 and HDMI MONITOR 2 connectors are connected and "HDMI Upscaler" is set to "Auto", the signals are output with a resolution that is compatible with both TVs. (🔗 p. 192)
- You can check which resolutions are compatible with your TV in "HDMI Monitor 1" and "HDMI Monitor 2". (🔗 p. 264)
- When connecting multiple Dolby Vision TVs, the signal will only be optimal for one TV. A TV connected to the HDMI MONITOR 1 connector has priority.

■ Video Mode

Configure the video processing method to match the type of video content.

Auto (Default):	Process video automatically based on the HDMI content information.
Game:	Always process video for game content. Minimize the video delay when the video is delayed compared to the button operations on the controller of the game console.
Movie:	Perform image processing that is suitable for contents other than games.
Bypass:	Remove all video processing from the HDMI video path.



- If "Video Mode" is set to "Auto", the mode is switched according to the input contents.
- Information displays such as the volume bar cannot be overlaid with the video signal when "Video Mode" is set to "Bypass".
- This item can be set when "HDMI" is assigned for each input source.
- This cannot be set when sound mode is set to "IMAX DTS" or "IMAX DTS:X".



■ HDMI Upscaler

Sets the mode for upscaling 1080p and 4K HDMI content to 8K.

Auto: Upscale 1080p and 4K HDMI video to 8K based on the monitor's capabilities.

Off
(Default): 8K upscaler is disabled.



- This item can be set when "HDMI" is assigned for each input source.
- This function is not effective when the input signal is "x.v.Color", 3D, sYCC601 color, Adobe RGB color, Adobe YCC601 color, computer resolutions, compressed video or HDR.
- This cannot be set when sound mode is set to "IMAX DTS" or "IMAX DTS:X".
- This item can be set when "Video Mode" is set to anything other than "Bypass". (🔍 p. 191)



On-Screen Display

Select the on-screen display user interface preferences.

■ Volume

Sets where to display the volume level.

Bottom (Default):	Display at the bottom.
Top:	Display at the top.
Off:	Turn display off.



- When the master volume display is hard to see when superimposed text (closed captioning) or movie subtitles are present, set to "Top".

■ Info

Displays status of operation temporarily when the input source is switched.

On (Default):	Turn display on.
Off:	Turn display off.

■ Now Playing

Sets the display time for the playback display when the input source is "HEOS Music".

Always On (Default):	Show display continuously.
Auto Off:	Show display for 30 seconds after operation.



Screensaver

Select the screen saver setting.

A screen saver is activated if no operation is performed for more than 5 minutes when no video signal is input or when the same screen (e.g. the setup menu) is displayed.

Use cursor Up/Down/Left/Right to clear the screen saver.

On:	Turns screen saver on.
Off (Default):	Turns screen saver off.



- The screen saver is activated in the following cases.
 - When the setup menu is displayed
 - When no video signal is input
 - When the HEOS Music, USB or Bluetooth playback screen is displayed

4K/8K Signal Format

Set the format of 4K and 8K signal to be played back by this unit when the TV or playback device connected to this unit is HDMI 4K or 8K signal compatible.

4K/8K Signal Format

Sets the signal format options for devices connected to each input on this unit.

Standard:	Select if your TV and the source device support 4K 60Hz 4:2:0 8 bit video signals.
Enhanced (Default):	Select if your TV, the source device, and cables support high quality 4K 60Hz 4:4:4 8 bit, 4:2:2 or 4:2:0 10 bit video signals.
8K Enhanced:	Select if your TV, the source device, and cables support high quality 8K 60Hz or 4K 120Hz video signals.



[Relation between the “4K/8K Signal Format” setting and supported resolutions]

Support Resolution	Color Space	Pixel Depth	4K/8K Signal Format		
			Standard	Enhanced	8K Enhanced
4K 24Hz, 4K 30Hz, 4K 25Hz	RGB / YCbCr 4:4:4	8 bit	✓	✓	✓
	YCbCr 4:2:2	10,12 bit	–	✓	✓
		12 bit	✓	✓	✓
4K 60Hz, 4K 50Hz	YCbCr 4:2:0	8 bit	✓	✓	✓
		10,12 bit	–	✓	✓
	RGB / YCbCr 4:4:4	8 bit	–	✓	✓
		10,12 bit	–	–	✓
		12 bit	–	✓	✓
4K 120Hz, 4K 100Hz	YCbCr 4:2:0	8,10,12 bit	–	–	✓
	RGB / YCbCr 4:4:4	8,10 bit	–	–	✓
		12 bit	–	–	✓
8K 24Hz, 8K 30Hz, 8K 25Hz	YCbCr 4:2:0	8,10,12 bit	–	–	✓
	RGB / YCbCr 4:4:4	8,10 bit	–	–	✓
		12 bit	–	–	✓
8K 60Hz, 8K 50Hz	YCbCr 4:2:0	8, 10 bit	–	–	✓



- When setting this to “Enhanced”, we recommend using a “Premium High Speed HDMI Cable” or “Premium High Speed HDMI Cable with Ethernet” that has an “HDMI Premium Certified Cable” label attached to the product package.
- When setting this to “8K Enhanced”, we recommend using a certified “Ultra High Speed HDMI cable”.
- When this setting is “8K Enhanced”, configure the television or playback device settings to match this setting.
- When this setting is “8K Enhanced”, video may not be output correctly depending on the connected playback device or HDMI cable. In this case, change this setting to “Enhanced” or “Standard”.
- “Custom” is displayed for the setting item if our service engineers or custom installers has configured the HDMI signal format for this unit.
- “4K/8K Signal Format” can also be set by the following procedure. However, the menu screen is not displayed. Watch the display while configuring the setting.
 1. Switch to the HDMI input source you want to set.
 2. Press and hold the main unit’s STATUS and ZONE3 SOURCE at the same time for at least 3 seconds.
“*Video Format <PAL>” appears on the display.
 3. Press cursor Down on the main unit.
“4K/8K Format <Enhanced>” appears on the display.
 4. Use cursor Left or cursor Right on the main unit to select the 4K/8K Signal Format.
 5. Press the main unit’s ENTER to complete the setting.



HDCP Setup

Sets the HDCP version for each HDMI input source.

Video may not be output depending on the HDCP version of your player and the TV.

If this issue occurs, use this setting to set one version of HDCP. This may be able to output video.

Auto (Default):	Automatically applies the HDCP version of this unit according to TV.
1.4:	Fixes the HDCP version of this unit to 1.4.
2.3:	Fixes the HDCP version of this unit to 2.3.



- “Custom” is displayed for the setting item if our service engineers or custom installers has configured the HDCP version for this unit.

TV Format

Set the video signal format to be output for the TV you are using.

■ Format

PAL
(Default): Select PAL output.

NTSC: Select NTSC output.



- “Format” can also be set by the following procedure. However, the menu screen is not displayed. Following the display content to make the setting.
 1. Press and hold the main unit’s STATUS and ZONE3 SOURCE at the same time for at least 3 seconds.
“*Video Format <PAL>” appears on the display.
 2. Use the main unit’s cursor Left or cursor Right and set the video signal format.
 3. Press the main unit’s ENTER to complete the setting.

NOTE

- When a format other than the video format of the connected TV is set, the picture will not be displayed properly.



Inputs

Perform settings related to input source playback.

You do not have to change the settings to use the unit. Make settings when needed.

Input Assign

By making connections as indicated by the input sources printed on the audio/video input connectors of this unit, you can just press one of the input source select buttons to easily play back audio or video from a connected device.

Please change the assignment of the HDMI input connector, digital audio input connector and analog audio input connector when connecting an input source that differs from that printed to the audio/video input connectors of this unit.

Sets the audio input mode for each “INPUT MODE” source. “AUTO” is normally recommended for this setting. This automatically detects and plays signal input to this unit prioritized in the following order: HDMI > DIGITAL > ANALOG.

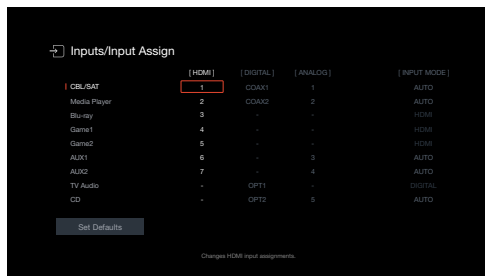

- By default, each item is set as follows.

Input source	Input connector			INPUT MODE
	HDMI	DIGITAL	ANALOG	
CBL/SAT	1	COAX1	1	AUTO
Media Player	2	COAX2	2	AUTO
Blu-ray	3	-	-	HDMI
Game1	4	-	-	HDMI
Game2	5	-	-	HDMI
AUX1	6	-	3	AUTO
AUX2	7	-	4	AUTO
TV Audio	-	OPT1	-	DIGITAL
CD	-	OPT2	5	AUTO



TV set top box/satellite users please note

When using the digital audio output on a TV/satellite box:

To play the video signal assigned to "HDMI" combined with the audio signal assigned at "Input Assign" - "DIGITAL", you will also need to select "DIGITAL" in the "INPUT MODE".



- The same input connector can be assigned to multiple input sources. For example, assign the same HDMI input connector to multiple sources to use each input source in combination with analog or digital audio as you prefer. In such cases, set the audio connector for playback in "INPUT MODE".

HDMI

Set this to change the HDMI input connectors assigned to the input sources.

1 / 2 / 3 / 4 / 5 / 6 / 7	Assign an HDMI input connector to the selected input source.
- :	Do not assign an HDMI input connector to the selected input source.



- When "HDMI Control" or "ARC" is set to "On" in the menu, "HDMI" cannot be assigned to "TV Audio". ("HDMI Control" (p. 188), "ARC" (p. 188))
- The eARC function does not operate when "HDMI" is set as the "TV Audio" input source.

DIGITAL

Set this to change the digital audio input connectors assigned to the input sources.

COAX1 (Coaxial) / COAX2 / OPT1 (Optical) / OPT2:	Assign a digital audio input connector to the selected input source.
- :	Do not assign a digital audio input connector to the selected input source.

ANALOG

Set this to change the analog audio input connectors assigned to the input sources.

1 / 2 / 3 / 4 / 5 / XLR:	Assign a analog audio input connector to the selected input source.
- :	Do not assign a analog audio input connector to the selected input source.





INPUT MODE

Set the audio input modes for each input source.
It is normally recommended to set the audio input mode to "AUTO".

AUTO (Default):	Automatically detect input signal and perform playback.
HDMI:	Play only signals from HDMI input.
DIGITAL:	Play only signals from digital audio input.
ANALOG:	Play only signals from analog audio input.



- When digital signals are properly input, the  indicator lights on the display. If the  indicator does not light, check "Input Assign" and the connections. (p. 197)
- If "HDMI Control" is set to "On" and a TV compatible with the ARC is connected via the HDMI MONITOR 1 connectors, the input mode whose input source is "TV Audio" is fixed to ARC.
- When an eARC function-compatible television is connected to the HDMI MONITOR 1 connector, the input mode whose input source is "TV Audio" is fixed to eARC.

Set Defaults

The "Input Assign" settings are returned to the default settings.



Source Rename

- Changes the display name of the input source.
Once changed, the name is displayed on the display and menu screens of this unit.
- If the device name can be acquired from a connected HDMI device, the display name is changed automatically.
Use this function to change names as needed when the device you are using differs from the input source on this unit.

**CBL/SAT / Media Player /
Blu-ray / Game1 / Game2 /
AUX1 / AUX2 / TV Audio /
CD / Phono / Tuner:**

Change the display name for input source.

Set Defaults:

The “Source Rename” settings are returned to the default settings.



- Up to 16 characters can be input.

Hide Sources

Remove from the display input sources that are not used.

Show
(Default):

Use this source.

Hide:

Do not use this source.



Source Level

This function corrects the playback level of the selected input source's audio input.

Make this setting if there are differences in the input volume levels between the different sources.

■ Source Level

□ When the input source is set to “HEOS Music”

-12 dB – +12 dB (Default : 0 dB)

■ Analog Inputs / Digital Inputs

□ When the input source is set other than to “HEOS Music”

-12dB – +12dB (Default : 0dB)



- The analog input level can be adjusted independently for input sources for which “ANALOG” is assigned at “Input Assign”. (👉 p. 197)
- The digital input level can be adjusted independently for input sources for which “HDMI” or “DIGITAL” is assigned at “Input Assign”. (👉 p. 197)
- “Source Level” settings are stored for each input source.



Speakers

The acoustic characteristics of the connected speakers and listening room are measured and the optimum settings are made automatically. This is called “Audyssey® Setup”.

You do not have to perform Audyssey® Setup when you have already performed “Speaker Calibration” in “Setup Assistant”.

To set up the speakers manually, use “Manual Setup” on the menu. (🔗 p. 213)

Audyssey® Setup

To perform measurement, place the Sound calibration microphone in multiple locations all around the listening area. For best results, we recommend you measure in six or more positions, as shown in the illustration (up to eight positions).

When measuring the second and subsequent positions, install the Sound calibration microphone within 60 cm of the first measurement position (main listening position).



- If you perform Audyssey® Setup, Audyssey MultEQ® XT32, Audyssey Dynamic EQ®, Audyssey Dynamic Volume® and Audyssey LFC™ functions are enabled. (🔗 p. 181)

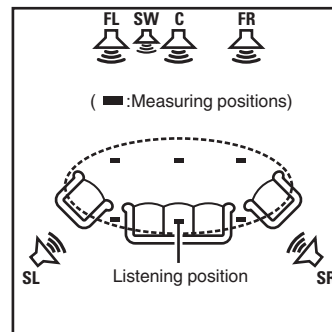

- FL** Front speaker (L)
- FR** Front speaker (R)
- C** Center speaker
- SW** Subwoofer
- SL** Surround speaker (L)
- SR** Surround speaker (R)



■ About the main listening position

The main listening position is the position where listeners would normally sit or where one would normally sit alone within the listening environment. Before starting Audyssey® Setup, place the Sound calibration microphone in the main listening position.

Audyssey MultEQ® XT32 uses the measurements from this position to calculate speaker distance, level, polarity, and the optimum crossover value for the subwoofer.

■ About Audyssey Sub EQ HT™

The Audyssey Sub EQ HT™ performs corrections based on the volume level and the distances of multiple subwoofers, and processes the Audyssey MultEQ® XT32 signal to reproduce a powerful low frequency sound.

To run Audyssey Sub EQ HT™ you must set “Measure (2 spkrs)”, “Measure (3 spkrs)” or “Measure (4 spkrs)” and set “Subwoofer Mode” to “Standard” in “Channel Select”. (🔧 p. 205).



- Audyssey Sub EQ HT will not work when “Subwoofer Mode” is set to “Directional”.

NOTE

- Make the room as quiet as possible. Background noise can disrupt the room measurements. Close windows and turn off the power on electronic devices (radios, air conditioners, fluorescent lights, etc.). The measurements could be affected by the sounds emitted by such devices.
- During the measurement process, place cell phones outside the listening room. Cell phone signals could disrupt the measurements.
- Do not stand between the speakers and Sound calibration microphone or allow obstacles in the path while the measurements are being made. Also, install the Sound calibration microphone at least 50 cm away from the wall. Failure to do so will result in inaccurate readings.
- During the measurement process, audible test tones will come from the speakers and subwoofer(s), but this is part of normal operation. If there is background noise in the room, these test signals will increase in volume.
- Operating VOLUME ▲▼ on the remote control unit or MASTER VOLUME on the main unit during the measurements will cancel the measurements.
- Measurement cannot be performed when headphones are connected. Unplug the headphones before performing Audyssey® Setup.



Procedure for speaker settings (Audyssey® Setup)

Preparation



Measurement



Calculation & Store



Check



Finish

- 1 Attach the Sound calibration microphone to the supplied microphone stand or own tripod and install it at the main listening position.**

When installing the Sound calibration microphone, point the tip of the microphone toward the ceiling and adjust the height to match the height of the ears of a listener in a seated position.

- 2 If using a subwoofer capable of the following adjustments, set up the subwoofer as shown below.**

When using a subwoofer with a direct mode

Set the direct mode to “On” and disable the volume adjustment and crossover frequency setting.

When using a subwoofer without a direct mode

Make the following settings:

- Volume : 10 o'clock position
- Crossover frequency : Maximum/Highest Frequency
- Low pass filter : Off
- Standby mode : Off



3 Connect the Sound calibration microphone to the SETUP MIC jack of this unit.

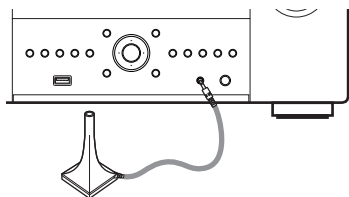

When the Sound calibration microphone is connected, the following screen is displayed.

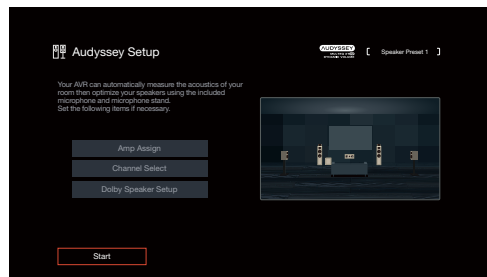

4 Select “Start”, then press ENTER.

Audyssey® Setup can also make the following settings.

- **Amp Assign**

The signals output from the SURROUND BACK, HEIGHT1, HEIGHT2 and HEIGHT3/FRONT WIDE speaker terminals can be switched in accordance with your speaker environment. (“Amp Assign” (📖 p. 213))

- **Channel Select**

If channels that are not to be used are set in advance, measurement for the set channels is skipped, and measuring time can be reduced. You can also change the number of surround back speakers and subwoofer.

- **Dolby Speaker Setup**

Set the distance between the Dolby Atmos Enabled speaker and the ceiling.

This can be set when using the Front Dolby Atmos Enabled, Surround Dolby Atmos Enabled or Back Dolby Atmos Enabled speaker.

5 Follow the instructions on the screen display and press “Next” to proceed further.



6 When the following screen is displayed, select “Begin Test” and then press ENTER.

Start the measurement of the first position.

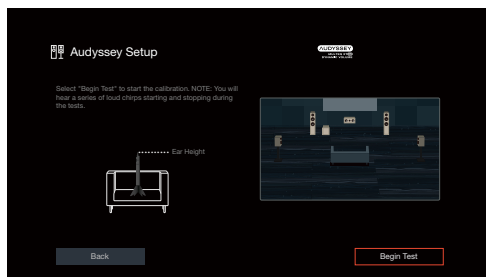

- Measurement requires several minutes.

NOTE

- If “**ERROR**” or “**CAUTION**” is displayed on TV screen:
 - Go to “Error messages” (🔍 p. 210). Check any related items, and perform the necessary procedures.
 - If the volume level for the subwoofer is not appropriate, an error message is displayed. See “Subwoofer level error message and how to adjust” (🔍 p. 211).

7 When the detected speaker is displayed, select “Next” and then press ENTER.

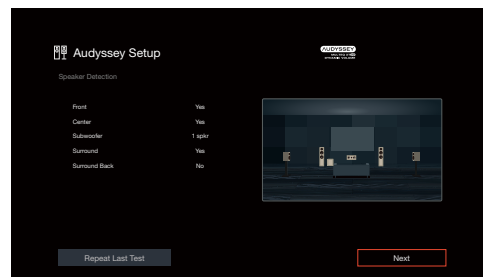

8 Move the Sound calibration microphone to position 2, select “Continue”, then press ENTER.

The measurement of the second position starts.

Measurements can be made in up to eight positions.

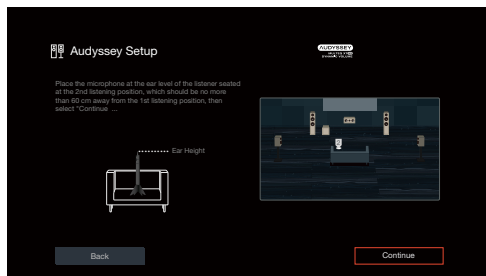

□ Stopping Audyssey® Setup

- ① Press BACK to display the popup screen.
- ② Press cursor Left to select “Yes”, then press ENTER.

9 Repeat step 8, measuring positions 3 to 8.



- To skip measuring the fourth and subsequent listening position, press cursor Left to select “Complete” and press ENTER to proceed to step 11.

10 Select “Continue”, then press ENTER.

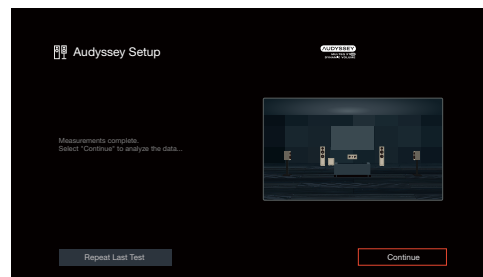

Start the analysis and storage of the measurement results.

- Analysis takes several minutes to complete.
The more speakers and measurement positions that there are, the more time it takes to perform the analysis.

NOTE

- When the measurement results are being saved, make sure the power is not turned off.



11 Perform the settings for Audyssey Dynamic EQ® and Audyssey Dynamic Volume®.

The following screen is displayed during the analysis. Configure the settings as preferred.

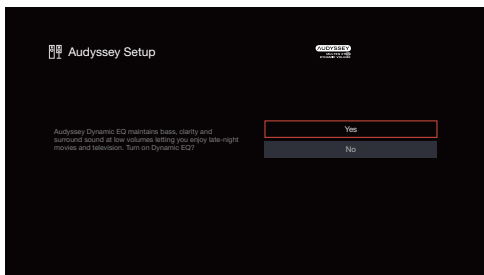

- Dynamic EQ corrects the frequency response in consideration of the audio characteristics of the room and human hearing ability so that sound can be heard even at low volume. This is recommended when using the unit with the volume turned down, e.g. when enjoying a movie or TV program in the middle of the night.
- Dynamic Volume adjusts the output volume to the optimal level while constantly monitoring the level of the audio input to the unit. Optimal volume control is performed automatically without any loss in the dynamism and clarity of the sound when, for example, the volume suddenly increases for commercials shown during television programs.

12 When the analysis and storage ends, unplug the Sound calibration microphone from the SETUP MIC jack on the main unit and then press “Next”.

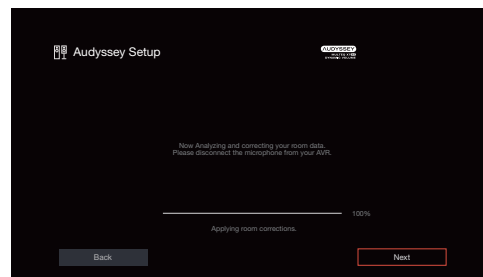



- When performing Audyssey® Setup for the first time, the measurement data is automatically saved to “Speaker Preset 1” of “Speaker Preset”.
- If Audyssey® Setup has already been performed, the following “Speaker Preset” selection screen is displayed.

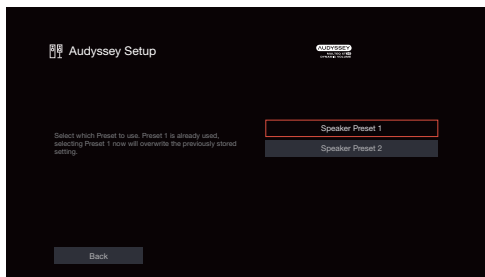

- See “Speaker Preset” for detailed information on the Speaker Preset function. (🔍 p. 242)

13 Select “Details” and press ENTER to verify the measurement results.

- Subwoofers may measure a greater reported distance than the actual distance due to added electrical delay common in subwoofers.

NOTE

- Do not enable new speakers in speaker configuration menu after Audyssey® Setup. If it is changed, run Audyssey® Setup again in order to configure the optimum equalizer settings.



Error messages

An error message is displayed if Audyssey® Setup could not be completed due to speaker placement, the measurement environment, etc. If an error message is displayed, check the relevant items and perform the necessary measures. Be sure to turn off the power before checking speaker connections.

Examples	Error details	Measures
No speakers found.	<ul style="list-style-type: none"> • Sound calibration microphone is not detected. • Not all speakers could be detected. 	<ul style="list-style-type: none"> • Connect the included Sound calibration microphone to the SETUP MIC jack of this unit. • Check the speaker connections.
Ambient noise is too high or level is too low	<ul style="list-style-type: none"> • There is too much noise in the room. • Speaker or subwoofer sound is too low. 	<ul style="list-style-type: none"> • Either turn off any device generating noise or move it away. • Perform again when the surroundings are quieter. • Check the speaker installation and the direction in which the speakers are facing. • Adjust the subwoofer's volume.
Front R : None	<ul style="list-style-type: none"> • The displayed speaker could not be detected. 	<ul style="list-style-type: none"> • Check the connections of the displayed speaker.
Front R : Phase	<ul style="list-style-type: none"> • The displayed speaker is connected with the polarity reversed. 	<ul style="list-style-type: none"> • Check the polarity of the displayed speaker. • For some speakers, this error message may be displayed even if the speaker is properly connected. If you are sure the connection is correct, press \triangleright to select "Ignore", then press ENTER.



■ Subwoofer level error message and how to adjust

The optimal level of each subwoofer channel for Audyssey® Setup measurement is 75 dB.

During subwoofer level measurement, an error message is displayed when one level of subwoofers is outside the 72 – 78 dB range.

When using a subwoofer with built-in amplifier (active type), adjust the subwoofer volume so that the subwoofer level is within the 72 to 78 dB range.

[Error message]

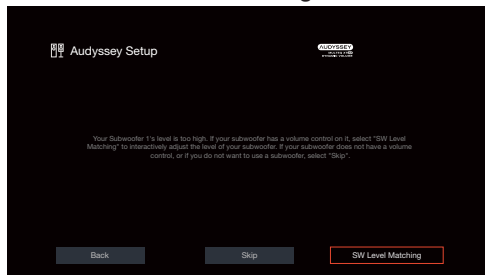

- 1 Select “SW Level Matching” and then press ENTER.
- 2 Adjust the volume control on your subwoofer so that the measured level is within the 72 to 78 dB range.
- 3 When the measured level is within the 72 to 78 dB range, select “Next” and then press ENTER.
 - If you use two subwoofers, the second subwoofer’s adjustment will be started. Repeat the operation from step 2, 3.



Retrieving Audyssey® Setup settings

If you set “Restore...” to “Restore”, you can return to Audyssey® Setup measurement result (value calculated at the start by MultEQ® XT32) even when you have changed each setting manually.

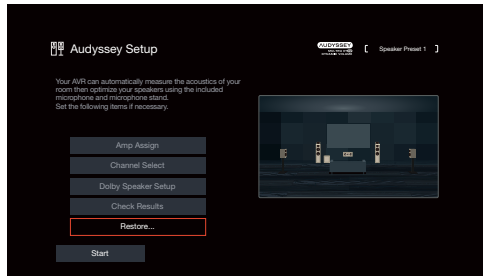

Manual Setup

Perform when setting the speakers manually or when changing settings made in Audyssey® Setup.

- If you enable new speakers in the speaker configuration menu after performing Audyssey® Setup, you will no longer be able to select Audyssey MultEQ® XT32, Audyssey Dynamic EQ® or Audyssey Dynamic Volume®. (🔗 p. 181)
- Changing the following settings:
Speaker size (Large or Small) / Distances / Levels / Crossovers settings will not disable Audyssey® or require running Audyssey® Setup again.
- “Manual Setup” can be used without changing the settings. Please set if necessary.

Amp Assign

Select the power amplifier usage method to match your speaker system.

■ Assign Mode

Select how to use the power amp.

You need to configure the detailed settings for the speaker configuration in accordance with the selected mode. Select Assign Mode configure the corresponding detailed settings.

15.1ch (Default):

- Settings to assign all power amplifier within this unit to MAIN ZONE to play back up to 15.1-channels.
- You can connect speakers for up to 17.1-channels for MAIN ZONE.

The speaker output automatically switches for playing back up to 15.1-channels in accordance with the input signal and sound mode when 17.1-channel speakers are installed.

13.1ch + ZONE2:

- Setting to assign the power amplifiers in this unit for ZONE2 to 2-channels.
- You can connect speakers for up to 13.1-channels for MAIN ZONE.



13.1ch + ZONE3:

- Setting to assign the power amplifiers in this unit for ZONE3 to 2-channels
- You can connect speakers for up to 13.1-channels for MAIN ZONE.

11.1ch + ZONE2/3:

- Setting to assign the power amplifiers within this unit for ZONE2 and ZONE3 each to two different channel.
- You can connect speakers for up to 11.1-channels for MAIN ZONE.

13.1ch + ZONE2/3-MONO:

- Setting to assign the power amplifiers in this unit for ZONE2 and ZONE3 each to a different channel.
- You can connect speakers for up to 13.1-channels for MAIN ZONE.

13.1ch (Bi-Amp):

- Setting to assign the power amplifiers in this unit for front speaker bi-amp connection to 2-channels.
- You can connect speakers for up to 13.1-channels for MAIN ZONE.

11.1ch (Bi-Amp) + ZONE2:

- Setting to assign the power amplifiers in this unit for front speaker bi-amp connection to 2-channels.
- Setting to assign the power amplifiers in this unit for ZONE2 to 2-channels.

7.1ch Full Bi-Amp:

- Setting to assign the power amplifiers in this unit for front, center and surround speakers to 10 channels.
- You can connect speakers for up to 7.1 channels for MAIN ZONE.

13.1ch + Front B:

- Setting to assign the power amplifiers within this unit for connecting the second set of front speakers.
 - You can switch between the desired combination of front speakers A and front speakers B.
- Switch the front speaker using the “Front Speaker” setting. (🔗 p. 238)



Preamplifier:

- All of the speakers are connected using an external power amplifier and this unit is used as a preamplifier.
- You can connect speakers for up to 17.1-channels for MAIN ZONE.

The pre-out output automatically switches for playing back up to 15.1-channels in accordance with the input signals and sound mode when 17.1-channel speakers are installed.

Custom:

- The internal amplifier of this unit is assigned as desired.
- You can connect speakers for up to 17.1-channels for MAIN ZONE.

Set the channel to be assigned to the speaker terminal in "Settings". (🔍 p. 224)

■ **Floor**□ **Layout**

Select the floor speakers location.

5ch & SB & FW
(Default):

This layout combines a surround back or front wide speaker with the basic 5-channel layout.

5ch & SB:

This layout combines a surround back speaker with the basic 5-channel layout.

5ch & FW:

This layout combines a front wide speaker with the basic 5-channel layout.

5ch:

This is a basic 5-channel layout that uses front speakers, center speakers and surround speakers.



■ Height

□ Height Sp

Select the number of the height speakers and ceiling speakers used in MAIN ZONE.

None:	Uses no height and ceiling speakers.
2ch:	Uses a set of (two) height speakers or ceiling speakers.
4ch (Default):	Uses two sets of (four) height speakers or ceiling speakers.
5ch:	Uses five height or ceiling speakers.
6ch:	Uses six height or ceiling speakers.
7ch:	Uses seven height or ceiling speakers.
8ch:	Uses eight height or ceiling speakers.



- Select the "5ch" setting or higher when using Top Surround or Center Height speakers.

□ Dolby Sp

Select the number of the Dolby Atmos Enabled speakers used in MAIN ZONE.

None (Default):	Uses no Dolby Atmos Enabled speakers.
2ch:	Uses a set of (two) Dolby Atmos Enabled speakers.
4ch:	Uses two sets of (four) Dolby Atmos Enabled speakers.
6ch:	Uses three sets of (six) Dolby Atmos Enabled speakers.



Layout

Set the speaker layout when installing 1 set (2-channels) of Height, Ceiling or Dolby Atmos Enabled speakers.

The layouts that can be selected differ depending on the combinations of "Assign Mode" and "Floor" in the menu. ("Assign Mode" (p. 213), "Floor" (p. 215))

[2-channel height speakers]

Settings			AUDIO OUT connectors			
Height Sp	Dolby Sp	Layout	HEIGHT 1	HEIGHT 2	HEIGHT 3	HEIGHT 4
None	None	-	-	-	-	-
2ch	None	Front Height	Front Height	-	-	-
		Top Front	Top Front	-	-	-
		Top Middle	Top Middle	-	-	-
		Top Rear	Top Rear	-	-	-
		Rear Height	Rear Height	-	-	-
None	2ch	Front Dolby	Front Dolby	-	-	-
		Surround Dolby	Surround Dolby	-	-	-
		Back Dolby *	Back Dolby *	-	-	-

* This can be selected when using Surround Back speakers. Set "Floor" in the menu to "5ch & SB" or "5ch & SB & FW". (p. 215)



□ Front Layout / Middle Layout / Rear Layout

Set the speaker layout when installing 2 sets (4-channels) or more of Height, Ceiling or Dolby Atmos Enabled speakers.

The layouts that can be selected differ depending on the combinations of “Assign Mode” and “Floor” in the menu. (“Assign Mode” (🔍 p. 213), “Floor” (🔍 p. 215))

[4-channel height speakers]

Settings				AUDIO OUT connectors				
Height Sp	Dolby Sp	NOTE	Front Layout	Rear Layout	HEIGHT 1	HEIGHT 2	HEIGHT 3	HEIGHT 4
4ch	None		Front Height	Top Middle	Front Height	Top Middle	-	-
			Front Height	Top Rear	Front Height	Top Rear	-	-
			Front Height	Rear Height	Front Height	Rear Height	-	-
			Front Height	Surround Height	Front Height	Surround Height	-	-
			Top Front	Top Rear	Top Front	Top Rear	-	-
			Top Front	Rear Height	Top Front	Rear Height	-	-
			Top Middle	Rear Height	Top Middle	Rear Height	-	-
2ch	2ch		Front Height	Surround Dolby	Front Height	Surround Dolby	-	-
			Front Height	Back Dolby*1	Front Height	Back Dolby	-	-
			Top Front	Surround Dolby	Top Front	Surround Dolby	-	-
			Top Front	Back Dolby	Top Front	Back Dolby	-	-
			Front Dolby	Top Rear	Front Dolby	Top Rear	-	-
None	4ch		Front Dolby	Rear Height	Front Dolby	Rear Height	-	-
			Front Dolby	Surround Dolby	Front Dolby	Surround Dolby	-	-
			Front Dolby	Back Dolby*1	Front Dolby	Back Dolby	-	-



[5-channel height speakers]

			Settings			AUDIO OUT connectors			
Height Sp	Dolby Sp	NOTE	Front Layout	Middle Layout	Rear Layout	HEIGHT 1	HEIGHT 2	HEIGHT 3	HEIGHT 4
5ch	None		Front Height	Top Surround	Rear Height*2	Front Height	Rear Height	L: Top Surround	-
			Front Height	Surround Height & Top Surround	None	Front Height	Surround Height	L: Top Surround	-
			Front Height & Center Height	None	Rear Height*2	Front Height	Rear Height	R: Center Height	-
			Front Height & Center Height	Surround Height	None	Front Height	Surround Height	R: Center Height	-



[6-channel height speakers]

		Settings				AUDIO OUT connectors			
Height Sp	Dolby Sp	NOTE	Front Layout	Middle Layout	Rear Layout	HEIGHT 1	HEIGHT 2	HEIGHT 3	HEIGHT 4
6ch	None		Front Height	Top Middle	Rear Height	Front Height	Rear Height	Top Middle	-
		*3	Front Height	Surround Height	Rear Height	Front Height	Rear Height	Surround Height	-
			Top Front	Top Middle	Top Rear	Top Front	Top Rear	Top Middle	-
			Front Height & Center Height	Top Surround	Rear Height	Front Height	Rear Height	L: Top Surround R: Center Height	-
			Front Height & Center Height	Surround Height & Top Surround	None	Front Height	Surround Height	L: Top Surround R: Center Height	-
4ch	2ch		Front Height	Surround Dolby	Rear Height	Front Height	Rear Height	Surround Dolby	-
			Top Front	Surround Dolby	Top Rear	Top Front	Top Rear	Surround Dolby	-



Settings						AUDIO OUT connectors			
Height Sp	Dolby Sp	NOTE	Front Layout	Middle Layout	Rear Layout	HEIGHT 1	HEIGHT 2	HEIGHT 3	HEIGHT 4
2ch	4ch		Front Height	Surround Dolby	Back Dolby*1	Front Height	Back Dolby	Surround Dolby	-
			Front Dolby	Top Middle	Back Dolby*1	Front Dolby	Back Dolby	Top Middle	-
			Front Dolby	Surround Dolby	Rear Height	Front Dolby	Rear Height	Surround Dolby	-
None	6ch		Front Dolby	Surround Dolby	Back Dolby*1	Front Dolby	Back Dolby	Surround Dolby	-

[7-channel heigh speakes]

Settings						AUDIO OUT connectors			
Height Sp	Dolby Sp	NOTE	Front Layout	Middle Layout	Rear Layout	HEIGHT 1	HEIGHT 2	HEIGHT 3	HEIGHT 4
7ch	None		Front Height	Top Middle & Top Surround	Rear Height	Front Height	Rear Height	Top Middle	L: Top Surround
			Front Height & Center Height	Top Middle	Rear Height	Front Height	Rear Height	Top Middle	R: Center Height
5ch	2ch		Front Height	Surround Dolby & Top Surround	Rear Height	Front Height	Rear Height	Surround Dolby	L: Top Surround
			Front Height & Center Height	Surround Dolby	Rear Height	Front Height	Rear Height	Surround Dolby	R: Center Height



[8-channel height speakers]

Settings						AUDIO OUT connectors			
Height Sp	Dolby Sp	NOTE	Front Layout	Middle Layout	Rear Layout	HEIGHT 1	HEIGHT 2	HEIGHT 3	HEIGHT 4
8ch	None		Front Height & Center Height	Top Middle & Top Surround	Rear Height	Front Height	Rear Height	Top Middle	L: Top Surround R: Center Height
6ch	2ch		Front Height & Center Height	Surround Dolby & Top Surround	Rear Height	Front Height	Rear Height	Surround Dolby	L: Top Surround R: Center Height

*1 This can be selected when using Surround Back speakers.

*2 For the best Auro-3D experience Surround Height speakers are recommended, however you may substitute Rear Height speakers from a Dolby Atmos speaker setup in place of Surround Height speakers.

*3 Use 2 sets of Height speakers in the appropriate sound modes for Dolby Atmos, DTS:X or Auro-3D playback.
Use the Front Height and Rear Height speakers for Dolby Atmos playback.
Use the Front Height, Surround Height and Rear Height speakers for DTS:X playback.
Use the Front Height and Surround Height speakers for Auro-3D playback.



■ Bi-Amp

When “Assign Mode” is “13.1ch (Bi-Amp)” and “11.1ch (Bi-Amp) + ZONE2”, the PRE OUT connector used for the bi-amp connection of the front speakers is displayed. Depending on the settings of “Floor” and “Height” - “Layout”, the connector is determined automatically.

HEIGHT 3:	The HEIGHT 3 speaker terminal is used for the bi-amp connection of the front speakers.
HEIGHT 2:	The HEIGHT 2 speaker terminal is used for the bi-amp connection of the front speakers.
FRONT WIDE:	The FRONT WIDE speaker terminal is used for the bi-amp connection of the front speakers.
SURROUND BACK:	The SURROUND BACK speaker terminal is used for the bi-amp connection of the front speakers.

■ Front B

When “Assign Mode” is “13.1ch + Front B”, the PRE OUT connector used for the second front speakers is displayed. Depending on the settings of “Floor” and “Height” - “Layout”, the connector is determined automatically.

HEIGHT 3:	The HEIGHT 3 speaker terminal is used for the second front speakers.
FRONT WIDE:	The FRONT WIDE speaker terminal is used for the second front speakers.
SURROUND BACK:	The SURROUND BACK speaker terminal is used for the second front speakers.



■ Settings

Select the signal to be output from the selected preout terminal.

- Only “Center” and “None” can be set for the CENTER preout terminal.
- If you are using a total of seven or more Height/Ceiling/Dolby Atmos Enabled speakers, you can only set “Top Middle”, “Surround Dolby”, or “None” for the HEIGHT 3 speaker terminal.
- You can use the HEIGHT 4 speaker terminal only if you are using a total of seven or more Height/Ceiling/Dolby Atmos Enabled speakers. You can only set “Top Surround”, “Center Height”, “TS/CH”, or “None” for the HEIGHT 4 speaker terminal.

■ View Terminal Config.

This shows how to connect the speaker terminals and PRE OUT connectors for your “Amp Assign” setting on the menu screen.



Speaker Configuration

Select whether or not speakers are present, playback capacity for low bass frequencies and speaker size.



- When speakers for which you assigned Height1 in “Amp Assign” are set to “None”, “None” is automatically set for Height2 and Height3.
- When speakers for which you assigned Height2 in “Amp Assign” are set to “None”, “None” is automatically set for Height3.

■ Front

Set the front speaker size.

Large (Default):	Use a large speaker that can adequately play back very low bass frequencies.
Small:	Use a small speaker that has inadequate playback capacity for very low bass frequencies.



- When “Subwoofer” is set to “No”, “Front” is automatically set to “Large”.
- When “Front” is set to “Small”, you cannot set speakers other than “Front” to “Large”.

■ Center

Set the presence and size of the center speaker.

Large:	Use a large speaker that can adequately play back very low bass frequencies.
Small (Default):	Use a small speaker that has inadequate playback capacity for very low bass frequencies.
None:	Select when a center speaker is not connected.

■ Subwoofer

Set the presence of a subwoofer.

4 spkrs:	Use four subwoofers.
3 spkrs:	Use three subwoofers.
2 spkrs:	Use two subwoofers.
1 spkr (Default):	Use only one subwoofer.
None:	Select when a subwoofer is not connected.



- When “Subwoofer” is set to “None” and you set “Front” to “Small”, “Subwoofer” is automatically set to “1 spkr”.



■ Subwoofer Mode

When you are using multiple subwoofers, set the audio to be output from the subwoofer.

Standard (Default):	All subwoofers output LFE signals and bass below the crossover frequency of all the speakers.
-------------------------------	-----------------------------------------------------------------------------------------------

Directional:	All subwoofers output LFE signals. In addition, each subwoofer outputs bass below the crossover frequency of speakers that are placed near them.
---------------------	--------------------------------------------------------------------------------------------------------------------------------------------------



- This can be set when “Subwoofer” is set to “4 spkrs”, “3 spkrs” or “2 spkrs”.

■ Subwoofer Layout

When you are using multiple subwoofers, configure the subwoofer layout. The layouts that can be selected differ depending on the configuration of “Subwoofer Mode”.

[When “Subwoofer” is set to “2 spkrs”]

Left/Right (Default):	Place subwoofers symmetrically on the front side.
---------------------------------	---------------------------------------------------

Front/Rear:	Place a subwoofer in the middle of the front side and another in the middle of the rear side.
--------------------	-----------------------------------------------------------------------------------------------

[When “Subwoofer” is set to “3 spkrs”]

FL/FR/Rear:	Place subwoofers symmetrically on the front side and one in the middle of the rear side.
--------------------	------------------------------------------------------------------------------------------

[When “Subwoofer” is set to “4 spkrs”]

FL/FR/RL/RR:	Place the subwoofers in the four corners of the room.
---------------------	-------------------------------------------------------





- This can be set when “Subwoofer” is set to “4 spkrs”, “3 spkrs” or “2 spkrs”, and “Subwoofer Mode” is set to “Directional”.
- The name of the Subwoofer that is displayed in the GUI of this unit depends on the setting combination of “Subwoofer”, “Subwoofer Mode”, and “Subwoofer Layout”.

Subwoofer	Subwoofer Mode	Subwoofer Layout	Subwoofer name			
			Subwoofer 1	Subwoofer 2	Subwoofer 3	Subwoofer 4
1 spkr	-	-	Subwoofer 1	-	-	-
2 spkrs	Standard	-	Subwoofer 1	Subwoofer 2	-	-
	Directional	Left/Right	Subwoofer Left	Subwoofer Right	-	-
		Front/Rear	Subwoofer Front	Subwoofer Rear	-	-
3 spkrs	Standard	-	Subwoofer 1	Subwoofer 2	Subwoofer 3	-
	Directional	FL/FR/Rear	Subwoofer FL	Subwoofer FR	Subwoofer Rear	-
4 spkrs	Standard	-	Subwoofer 1	Subwoofer 2	Subwoofer 3	Subwoofer 4
	Directional	FL/FR/RL/RR	Subwoofer FL	Subwoofer FR	Subwoofer RL	Subwoofer RR



- With the “Directional” setting, your room is divided into four areas as shown below so that each subwoofer plays the bass of the speaker set to “Small” which is located within the area.

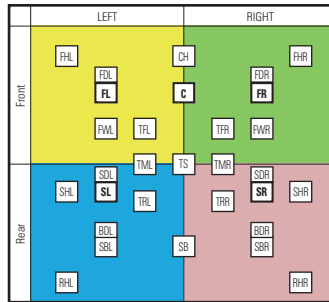

For example, if Subwoofer = 2 spkrs and Subwoofer Layout = Left/Right, Subwoofer Left (Subwoofer 1) plays the bass of the speakers in the Left area which includes FL/SL and Subwoofer Right (Subwoofer 2) plays the bass of the speakers in the Right area which includes FR/SR.



■ Surround

Set the presence and size of the surround speakers.

Large:	Use a large speaker that can adequately play back very low bass frequencies.
Small (Default):	Use a small speaker that has inadequate playback capacity for very low bass frequencies.
None:	Select when the surround speakers are not connected.



- When "Surround" is set to "None", "Surround Back", "Front Wide", "Surround Dolby" and "Back Dolby" are automatically set to "None".

■ Surround Back

Set the presence, size and number of surround back speakers.

Large:	Use a large speaker that can adequately play back very low bass frequencies.
Small (Default):	Use a small speaker that has inadequate playback capacity for very low bass frequencies.
None:	Select when the surround back speakers are not connected.

2 spkrs (Default):	Use two surround back speakers.
1 spkr:	Use only one surround back speaker. Connect to the L terminal to SURROUND BACK when this setting is selected.



- When "Surround Back" is set to "None" or "1 spkr", "Back Dolby" is automatically set to "None".



■ Front Wide

Set the presence and size of the front wide speakers.

Large:	Use a large speaker that can adequately play back very low bass frequencies.
Small (Default):	Use a small speaker that has inadequate playback capacity for very low bass frequencies.
None:	Select when the front wide speakers are not connected.

■ Front Height

Set the presence and size of the front height speakers.

Large:	Use a large speaker that can adequately play back very low bass frequencies.
Small (Default):	Use a small speaker that has inadequate playback capacity for very low bass frequencies.
None:	Select when the front height speakers are not connected.

■ Front Dolby

Set the presence and size of the front Dolby speakers.

Large:	Use a large speaker that can adequately play back very low bass frequencies.
Small (Default):	Use a small speaker that has inadequate playback capacity for very low bass frequencies.
None:	Select when the front Dolby speakers are not connected.

■ Top Front

Set the presence and size of the top front speakers.

Large:	Use a large speaker that can adequately play back very low bass frequencies.
Small (Default):	Use a small speaker that has inadequate playback capacity for very low bass frequencies.
None:	Select when the top front speakers are not connected.



■ Top Middle

Set the presence and size of the top middle speakers.

Large:	Use a large speaker that can adequately play back very low bass frequencies.
Small (Default):	Use a small speaker that has inadequate playback capacity for very low bass frequencies.
None:	Select when the top middle speakers are not connected.

■ Surround Dolby

Set the presence and size of the surround Dolby speakers.

Large:	Use a large speaker that can adequately play back very low bass frequencies.
Small (Default):	Use a small speaker that has inadequate playback capacity for very low bass frequencies.
None:	Select when the surround Dolby speakers are not connected.

■ Top Rear

Set the presence and size of the top rear speakers.

Large:	Use a large speaker that can adequately play back very low bass frequencies.
Small (Default):	Use a small speaker that has inadequate playback capacity for very low bass frequencies.
None:	Select when the top rear speakers are not connected.

■ Surround Height

Set the presence and size of the surround height speakers.

Large:	Use a large speaker that can adequately play back very low bass frequencies.
Small (Default):	Use a small speaker that has inadequate playback capacity for very low bass frequencies.
None:	Select when the surround height speakers are not connected.



- When "Front Height" is set to "None", "Surround Height" is automatically set to "None".



■ Rear Height

Set the presence and size of the rear height speakers.

Large:	Use a large speaker that can adequately play back very low bass frequencies.
Small (Default):	Use a small speaker that has inadequate playback capacity for very low bass frequencies.
None:	Select when the rear height speakers are not connected.

■ Back Dolby

Set the presence and size of the back Dolby speakers.

Large:	Use a large speaker that can adequately play back very low bass frequencies.
Small (Default):	Use a small speaker that has inadequate playback capacity for very low bass frequencies.
None:	Select when the back Dolby speakers are not connected.



- When speakers for which you assigned Height1 in "Amp Assign" are set to "None", "None" is automatically set for Height2 and Height3.



■ Center Height

Set the presence and size of the center height speaker.

Large:	Use a large speaker that can adequately play back very low bass frequencies.
Small (Default):	Use a small speaker that has inadequate playback capacity for very low bass frequencies.
None:	Select when the center height speaker is not connected.



- When “Surround Height” or “Rear Height” is set to “None”, “Center Height” is automatically set to “None”.
- When “Center” is set to “None”, “Center Height” is automatically set to “None”.

■ Top Surround

Set the presence and size of the top surround speaker.

Large:	Use a large speaker that can adequately play back very low bass frequencies.
Small (Default):	Use a small speaker that has inadequate playback capacity for very low bass frequencies.
None:	Select when the top surround speaker is not connected.



- When “Surround Height” or “Rear Height” is set to “None”, “Top Surround” is automatically set to “None”.



Distances

Set distance from listening position to speakers.

Measure beforehand the distance from the listening position to each speaker.

Unit

Set the unit of distance.

Meters (Default)

Feet

Step

Set the minimum variable width of the distance.

0.1 m / 0.01 m (Default: 0.1 m)

1 ft / 0.1 ft

Set the distance

0.00 m – 18.00 m / 0.0 ft – 59.1 ft



- The speakers that can be selected differ depending on the “Amp Assign” and “Speaker Configuration” settings. (“Amp Assign” (p. 213), “Speaker Configuration” (p. 225))
- Default settings:
Front L / Front R / Front Height L / Front Height R / Center / Front Wide L / Front Wide R / Front Dolby L / Front Dolby R / Subwoofer 1 / Subwoofer 2 / Subwoofer 3 / Subwoofer 4: 3.60 m (11.8 ft)
Speakers other than the above: 3.00 m (9.8 ft)
- Set the difference in the distance between the speakers to less than 6.00 m (19.7 ft).



■ Dolby Speaker Setup

Set the distance between the Dolby Atmos Enabled speaker and the ceiling.

0.90 m - 3.30 m / 3.0 ft - 10.8 ft
(Default : 1.80 m / 5.9 ft)



- This can be set when “Front Dolby”, “Surround Dolby” or “Back Dolby” is set to “Large” or “Small” in “Speaker Configuration”.

■ Set Defaults

The “Distances” settings are returned to the default settings.

Levels

Set the volume of the test tone to be the same at the listening position when it is output from each speaker.

■ Test Tone Start

A test tone is output from the selected speaker.

While listening to the test tone, adjust the volume output from the selected speaker.

-12.0 dB – +12.0 dB (Default : 0.0 dB)



- The set “Levels” are reflected in all sound modes.
- If you wish to adjust the channel level for each input source, carry out the settings in “Channel Level Adjust”. (p. 120)
- When headphones are connected to the PHONES connector on this unit, you cannot set “Levels”.

■ Set Defaults

The “Levels” settings are returned to the default settings.



Crossovers

Set in accordance with the lower limit frequency of the base frequencies that can be played back through each speaker. See the speaker manual for information concerning speaker crossover frequency.

■ Set the crossover frequency

40 Hz / 60 Hz / 80 Hz / 90 Hz / 100 Hz / 110 Hz / 120 Hz / 150 Hz / 180 Hz / 200 Hz / 250 Hz (Default: 80 Hz)



- “Crossovers” can be set when the “Subwoofer Output” setting is “LFE + Main”, or when you have a speaker that is set to “Small”. (🔧 p. 236)
- The default crossover frequency is “80 Hz”, which will work best with the widest variety of speakers. We recommend setting to a higher frequency that the crossover frequency when small speakers are used. For example, set to “250 Hz” when the frequency range of the speakers is 250 Hz – 20 kHz.
- Sound below the crossover frequency is cut off from the output of the speakers set in “Small”. This cut off bass frequency is output from the subwoofer or front speakers.
- The speakers that can be set differ depending on to the “Subwoofer Output” setting. (🔧 p. 236)
 - When “LFE” is selected, speakers set to “Small” at “Speaker Configuration” can be set. If the speakers are set to “Large”, “Full Band” is displayed and the setting cannot be made. (🔧 p. 225)
 - When “LFE + Main” is selected, speakers can be set regardless of the “Speaker Configuration” setting. (🔧 p. 225)
- The audio settings in “IMAX Audio Settings” are applied during IMAX playback. (🔧 p. 174)

Bass

Set subwoofer and LFE signal range playback.

■ Subwoofer Output

Selects which low frequency signals are sent to the subwoofer outputs.

LFE
(Default):

The subwoofer outputs receive the LFE track, plus any redirected bass from speakers with crossovers set. Use this setting as the default for home theater bass management in a typical room.

LFE + Main:

The subwoofer outputs receive the LFE track, plus redirected bass, and a copy of the low frequency signals from all large speakers.



- “Subwoofer Output” can be set when “Speaker Configuration” - “Subwoofer” in the menu is set to other than “None”. (🔧 p. 225)
- Play music or a movie source and select the mode offering the strongest bass.
- If “Speaker Configuration” - “Front” and “Center” are set to “Large”, and “Subwoofer Output” is set to “LFE”, no sound may be output from the subwoofers, depending on the input signal or selected sound mode. (🔧 p. 225)
Select “LFE + Main” if you want the bass signals to always be produced from the subwoofer.
- The audio settings in “IMAX Audio Settings” are applied during IMAX playback. (🔧 p. 174)



■ LPF for LFE

Selects the crossover point for the LFE channel. Set this when you want to change the playback LFE signal of the subwoofer.

80 Hz / 90 Hz / 100 Hz / 110 Hz / 120 Hz / 150 Hz / 180 Hz /
200 Hz / 250 Hz (Default: 120 Hz)



- The audio settings in "IMAX Audio Settings" are applied during IMAX playback. (🔍 p. 174)

■ LFE Distribution

Adjusts the amount of LFE signal sent to the large floor speakers.

Off
(Default): Floor Speakers do not play LFE signals.

-20 dB – 0 dB
Adjusts the amount of LFE signal sent to the large floor speakers.



- This setting cannot be set when the "Front", "Center", "Surround", "Surround Back", and "Front Wide" settings of "Speaker Configuration" are all "Small".

XLR Output Assign

Selects the audio channel to send to the subwoofer XLR outputs.

■ Subwoofer 1 (2/3/4) XLR Output

Subwoofer 1 (2/3/4)
(Default): Assigns the subwoofer 1 channel to the SUBWOOFER XLR output.

Front L: Assigns the front left channel to the SUBWOOFER XLR output.

Front R: Assigns the front right channel to the SUBWOOFER XLR output.

Center: Assigns the center channel to the SUBWOOFER XLR output.

None: The SUBWOOFER XLR output is not used.



- Only the subwoofer signal that has the same number as the terminal number can be assigned.
- The name of the subwoofer signal changes depending on the configuration of "Subwoofer Mode" (🔍 p. 226) and "Subwoofer Layout" (🔍 p. 226).



Front Speaker

Set the front speaker A/B to use for every sound mode.

A (Default):	Front speaker A is used.
B :	Front speaker B is used.
A+B :	Both front speakers A and B are used.



- This can be set when “Assign Mode” is set to “13.1ch + Front B”. (🔍 p. 214)

2ch Playback

Select the method for setting the speakers used in the 2-channel direct and stereo playback modes.

■ Setting

Select the method for setting the speakers used in the 2-channel direct and stereo playback modes.

Auto (Default):	The settings in “Speakers” are applied. (🔍 p. 202)
Manual:	Set the speakers for 2-channel playback. Make the following settings:

■ Front

Set the size of the front speakers for 2-channel playback.

Large:	Use a large speaker that can adequately play back very low bass frequencies.
Small (Default):	Use a small speaker that has inadequate playback capacity for very low bass frequencies.



- When “Speaker Configuration” - “Subwoofer” in the menu is set to “None”, “Large” is automatically set. (🔍 p. 225)



■ Subwoofer

Set the presence of a subwoofer.

Yes (Default):	Use a subwoofer.
No:	Select when a subwoofer is not connected.



- When “Speaker Configuration” - “Subwoofer” in the menu is set to “None”, No is automatically set. (🔍 p. 225)
If the “Front” setting is “Small”, the setting is automatically “Yes”.

■ Subwoofer Output

Selects which low frequency signals are sent to the subwoofer outputs.

LFE (Default):	When “2ch Playback” - “Front” is set to “Large”, only LFE signals are output from the subwoofer. Also, when “2ch Playback” - “Front” is set to “Small”, the front channel low range signals are added to the LFE signals and output from the subwoofer.
LFE + Main:	The front channel low range signal is added to the LFE signal output from the subwoofer.



- This can be set when “2ch Playback” - “Subwoofer” is set to “Yes”.



■ Crossover

Set the maximum frequency of the bass signal output from each channel to the subwoofer.

40 Hz / 60 Hz / 80 Hz / 90 Hz / 100 Hz / 110 Hz / 120 Hz / 150 Hz / 180 Hz / 200 Hz / 250 Hz (Default: 80 Hz)



- This can be set when “2ch Playback” - “Subwoofer” is set to “Yes”.
- When “2ch Playback” - “Front” is set to “Large” and “Subwoofer Output” is set to “LFE”, “Full Band” is displayed and this cannot be set.

■ LFE Distribution

Adjusts the amount of LFE signal sent to the large front speakers.

Off
(Default): Front Speakers do not play LFE signals.

-20 dB – 0 dB Adjusts the amount of LFE signal sent to the front speakers



- This setting cannot be set when “2ch Playback” - “Front” is set to “Small”.

■ Distance FL / Distance FR

Set distance from main listening position to speaker.

0.00 m – 18.00 m (Default : 3.60 m) /
0.0 ft – 59.1 ft (Default : 11.8 ft)



- Set the difference in the distance between the speakers to less than 6.00 m (19.7 ft).

■ Level FL / Level FR

Adjust the level of each channel.

-12.0 dB – +12.0 dB (Default: 0.0 dB)



Tactile Transducer Setup

Set the level and low pass filter cutoff frequency when using tactile transducers.

■ Tactile Transducer

Sets the tactile transducer option.

Enabled: Enables tactile transducers.

Disabled (Default): Disables the tactile transducers.



- For Tactile Transducer connections, use the Subwoofer 4 PRE OUT connector.
- This can not be set when “Speaker Configuration” - “Subwoofer” is set to “4 spkrs”.

■ Level

Adjusts the volume of the tactile transducer output.

-12.0 dB – +12.0 dB (Default : 0.0 dB)



- The “Level” are reflected in all input sources.
- If you wish to adjust the tactile transducer level for each input source, carry out the settings in “Tactile Transducer”. (☞ p. 123)

■ Low Pass Filter

Selects the low pass filter cutoff frequency for the tactile transducer output.

40 Hz / 60 Hz / 80 Hz / 90 Hz / 100 Hz / 110 Hz / 120 Hz / 150 Hz / 180 Hz / 200 Hz / 250 Hz (Default: 80 Hz)

- The “Low Pass Filter” are reflected in all input sources.



Speaker Connection

Selects which speaker and/or pre-out terminals to use for each channel.

■ Select the connection

Speaker + Pre-out
(Default): Speaker and pre-out outputs are active.

Pre-out Only: Pre-out outputs are active. Speaker outputs are disconnected for enhanced audio quality using only the pre-out terminals.



- This can not be set when “Amp Assign” is set to “Preamplifier” or “Custom”.
(p. 215)

Speaker Preset

Two speaker settings can be saved to suit the environments where you use your speakers.

For example, you can configure two presets easily to switch between equalizer or speaker settings measured using Audyssey® Setup if the characteristics of your room differ depending on factors such as whether you use the screen.

If you want to use a preset, select the preset you want to use and then configure settings such as Audyssey® Setup or the speaker settings to save those settings to the preset you have selected.

Speaker Preset 1
(Default): Saves the settings to Preset 1.

Speaker Preset 2: Saves the settings to Preset 2.



- The following settings are saved to presets.
 - “Amp Assign” settings
 - “Speaker Configuration” settings
 - “Distances” settings
 - “Levels” settings
 - “Crossovers” settings
 - “Bass” settings
 - “2ch Playback” settings
 - “Front Speaker” settings
 - “MultEQ® XT32” data
 - “Graphic EQ” data
- This setting also be configured using “Speaker Preset” in the option menu.
(p. 126)



Network

To use this unit by connecting it to a home network (LAN), you must configure network settings.

If you set up your home network (LAN) via DHCP, set “DHCP” to “On”. (Use the default setting.) This allows this unit to use your home network (LAN). When assigning an IP address to each device manually, you need to assign an IP address to this unit using the “IP Address” settings, and enter information about your home network (LAN) such as the gateway address and subnet mask, etc.

Information

Display network information.

**Friendly Name / Connection / SSID / DHCP / IP Address /
MAC Address (Ethernet) / MAC Address (Wi-Fi) /
Wi-Fi signal strength**

Connection

Choose whether to connect the home network to a wireless LAN or a wired LAN.

When connecting to the network using wired LAN, select “Wired (Ethernet)” after connecting a LAN cable.

When connecting to the network using wireless LAN, select “Wireless (Wi-Fi)” and configure the “Wi-Fi Setup”. (🔧 p. 244)

■ Connect Using

Select the method for connecting to the home network (LAN).

Wired (Ethernet):	Use a LAN cable to connect to a network.
Wireless (Wi-Fi) (Default):	Use the wireless LAN (Wi-Fi) function to connect to a network.



- “Wired (Ethernet)” is set when “Wi-Fi” is set to “Disabled”. (🔧 p. 250)



Wi-Fi Setup

Connect to a wireless LAN (Wi-Fi) router.

The router can be connected in the following ways. Select the connection method to suit your home environment.

■ Scan Networks

Select the network you wish to connect to from the list of possible networks shown on the TV screen.

1. Select the network you wish to connect to from the list of wireless networks.

Select "Rescan" if the network cannot be found.

2. Enter your password and select "OK".

■ Use iOS Device

Use your iOS device (iPhone/iPod/iPad) to connect to the network. By connecting your iOS device to this unit using Wi-Fi, the unit can be automatically connected to the same network as your device.

1. Select "Use iOS Device" on the TV screen.
2. Check that your iOS device is connected to the wireless LAN (Wi-Fi) router and select "Denon AVC-A1H" from "SET UP NEW AIRPLAY SPEAKER..." at the bottom of the Wi-Fi configuration screen of your iOS device.
3. Tap "Next" on the screen of the iOS device.



- The iOS device firmware version needs to support iOS 10.0.2 or later.



■ WPS Router

Use a WPS-compatible router to connect using the push button method.

1. Select "Push Button" on the TV screen.
2. Switch to the WPS mode by pressing the WPS button of the router you wish to connect to.
 - The time for pressing the button varies depending on the router.
3. Select "Connect" on the TV screen within 2 minutes.

■ Manual

Enter the name (SSID) and password of the network you wish to connect to.

1. Set the following items.

SSID:	Input the name of the wireless network (SSID).
Security:	Select the encryption method according to the encryption setting of the access point you are using.
Password:	Input the password.

2. Select "Connect" at the end of the setting.



- The Default key of this unit is fixed at "1". Set Default key of the router to "1" to use.



Settings

Configure the IP address.

- If you are using a broadband router (DHCP function), the information required for network connection such as the IP address will be automatically configured since the DHCP function is set to “On” in the default settings of this unit.
- Set up the IP Address, Subnet Mask, Default Gateway and DNS server information only when assigning a fixed IP address or when connecting to a network without DHCP function.

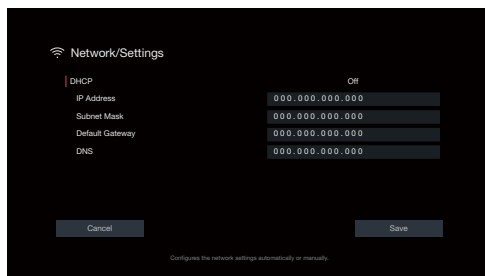

■ DHCP

Selects how to connect to the network.

On (Default):	Configure the network settings automatically from your router.
Off:	Configure the network settings manually.

■ IP Address

Set the IP address within the ranges shown below.

- The Network Audio function cannot be used if other IP addresses are set.

CLASS A: 10.0.0.1 - 10.255.255.254

CLASS B: 172.16.0.1 - 172.31.255.254

CLASS C: 192.168.0.1 - 192.168.255.254

■ Subnet Mask

When connecting an xDSL modem or connector adapter directly to this unit, input the subnet mask indicated in the documentation supplied by your provider. Normally input “255.255.255.0”.



■ Default Gateway

When connected to a gateway (router), input its IP address.

■ DNS

Enter the DNS address indicated in the documentation supplied by your provider.



- If you cannot connect to the Internet, recheck the connections and settings. (🔗 p. 79)
- If you do not understand about Internet connection, contact your ISP (Internet Service Provider) or the store from which you purchased your computer.

Network Control

Enables network communication in standby power mode.

Off In Standby
(Default):

Suspend network function during standby.

Always On:

Network is on during standby. Main unit operable with a network compatible controller.



- When using the web control function, Denon AVR Remote App or HEOS App, use with the “Network Control” setting set to “Always On”.

NOTE

- When “Network Control” is set to “Always On”, the unit consumes more standby power.



Friendly Name

The Friendly Name is the name of this unit displayed on the network. You can change the Friendly Name according to your preferences.

■ Friendly Name

Selects Friendly Name from the list.

When you select “Other”, you can change the Friendly Name according to your preferences.

Home Theater / Living Room / Family Room / Guest Room / Kitchen / Dining Room / Master Bedroom / Bedroom / Den / Office / Other



- Up to 30 characters can be input.
- The default Friendly Name on first use is “Denon AVC-A1H”.

■ Set Defaults

Restores Friendly Name, which you had changed, to the default setting.

Diagnostics

Used to check the network connection.

■ Physical Connection

Checks the physical LAN port connection.

OK

Error:

The LAN cable is not connected. Check the connection.



- When connected using a wireless LAN, “Connection Wireless (Wi-Fi)” will be displayed.

■ Router Access

Checks the connection from this unit to the router.

OK

Error:

Failed to communicate with the router. Check the router settings.



■ Internet Access

Checks whether this unit has access to the Internet (WAN).

OK

Error:

Failed to connect to the Internet. Check the Internet connection environment or router settings.

AirPlay

Settings for Apple AirPlay.

■ AirPlay Name

Displays the name which identifies this unit on Apple devices.



- If you registered this unit to the Apple Home app, use the app to change the name.

■ AirPlay

Enables/disables the Apple AirPlay.

On
(Default): Enables Apple AirPlay.

Off: Disables Apple AirPlay.



Spotify Connect

Toggles access to Spotify Connect.

On (Default):	Enables Spotify Connect.
Off:	Disables Spotify Connect.

Wi-Fi and Bluetooth

Enables/disables the Wi-Fi and Bluetooth radios.

■ Wi-Fi

The Wi-Fi function can be stopped to prevent noise that affects the sound quality. Using a wired LAN to connect this unit to the network enables playback with a high sound quality.

Enabled (Default):	Enables the Wi-Fi function.
------------------------------	-----------------------------

Disabled:	Disables the Wi-Fi function.
------------------	------------------------------

■ Bluetooth

Stopping Bluetooth receiver and transmitter functions reduces a source of noise that affects sound quality, enabling higher sound quality playback.

Enabled (Default):	Enables the Bluetooth function.
------------------------------	---------------------------------

Disabled:	Disables the Bluetooth function.
------------------	----------------------------------



HEOS Account

Make HEOS Account-related settings.

HEOS Account is needed in order to use HEOS Favorites.

The menu displayed differs depending on the status of the HEOS Account.

You have not signed in

■ I have a HEOS Account

If you already have a HEOS Account, enter the current account name and password to sign in.

■ Create Account

If you do not have a HEOS Account, create a new HEOS Account.

■ Forgot Password

If you have forgotten the password, an email explaining how to reset the password will be sent.

You have already signed in

■ Signed in as

The currently signed in HEOS Account is displayed.

■ Change Location

Change the regional settings for the signed in HEOS Account.

■ Change Password

Change the password for the signed in HEOS Account.

■ Delete Account

Delete the signed in HEOS Account.

■ Sign Out

Sign out from the HEOS Account.



General

Make various other settings.

Language

Set the language for display the menu on the TV screen.

English / Deutsch / Français / Italiano / Español / Nederlands / Svenska / Русский / Polski (Default : English)



- "Language" can also be set up by the following operation. However, the menu screen is not displayed. Watch the display while configuring the settings.
 1. Press and hold the main unit's STATUS and ZONE3 SOURCE at the same time for at least 3 seconds.
" *Video Format <PAL>" appears on the display.
 2. Press cursor Down on the main unit twice.
" *GUI Language <ENGLISH>" appears on the display.
 3. Use the main unit's cursor Left or cursor Right and set the language.
 4. Press the main unit's ENTER to complete the setting.

Owner's Manual

Shows URL and QR code to access the online Owner's Manual from your mobile device.

ECO

Configure the ECO Mode and auto standby mode settings.

■ ECO Mode





This mode can reduce the power consumption and heat generation of this unit when power on.

This is done by reducing the power supply line to the power amplifier, in turn the maximum power output.



On:	Power savings are always active, regardless of volume or input signal.
	Gives you the best balance between power savings and maximum power output: For low volume levels, the power savings are active. If you increase the volume level, the power savings are switched off automatically, so you can enjoy maximum output power without distortion.
Auto (Default):	If the volume is set to a high level but no input signal is detected for more than 2 minutes, this unit will enable power savings. When an input signal is detected again or the input source is changed, this unit will automatically turn off power savings again at high volume levels.
Off:	No power savings.



- When the unit is switching between the different power saving states in “ECO Mode: Auto”, you may notice a click noise from the inside of this unit, this is normal.
- If content is paused for more than 2 minutes and playback is resumed from the same source at these high volume levels, there may be short delay before maximum power is restored.
- “ECO Mode” can also be switched by pressing ECO  on the remote control unit.
- “ECO Mode” cannot be set when “Amp Assign” is set to “Preamplifier” ( p. 215) or speaker impedance is set to 4 Ω/ohms ( p. 38). Furthermore, “ECO Mode” cannot be switched by pressing ECO  on the remote control unit.



■ Power On Default

Set the mode to ECO when the power is on.

Last (Default):	The ECO Mode will be set to the previous setting before the power was switched off.
On:	When power is turned on, the mode will always be switched to the ECO Mode in "On".
Auto:	When power is turned on, the mode will always be switched to the ECO Mode in "Auto".
Off:	When power is turned on, the mode will always be switched to the ECO Mode in "Off".

■ On Screen Display

Display the power consumption of this unit using a meter on the TV screen.

Always On:	Always display the meter on the TV screen.
Auto (Default):	Display the meter when changing the mode or volume.
Off:	Do not display the meter.



■ Auto Standby

Set so the unit power automatically switches to standby.

□ MAIN ZONE

Sets the time for switching to auto standby when there are no audio or video signals input into this unit.

Before the unit enters standby mode, "Auto Standby" is displayed on the unit display and the menu screen.

60 min:	The unit goes into standby after 60 minutes.
30 min:	The unit goes into standby after 30 minutes.
15 min (Default):	The unit goes into standby after 15 minutes.
Off:	The unit does not go into standby automatically.

□ ZONE2 / ZONE3

When there are no operations for a certain period of time as set here, the power is automatically shut off even if there is audio or video input.

8 hours:	Switches ZONE2/ZONE3 the standby state after about 8 hours.
4 hours:	Switches ZONE2/ZONE3 to the standby state after about 4 hours.
2 hours:	Switches ZONE2/ZONE3 to the standby state after about 2 hours.
Off (Default):	Does not automatically switch ZONE2/ ZONE3 to the standby state.



Bluetooth Transmitter

Sets this unit's Bluetooth transmitter.

Set to use Bluetooth headphones to listen to audio playing in the MAIN ZONE.

Transmitter

Enables or disables the Bluetooth transmitter.

On:	Enables the Bluetooth transmitter feature.
Off (Default):	Disables the Bluetooth transmitter feature.

Output Mode

Selects the audio output method.

Bluetooth + Speakers (Default):	Audio is output to Bluetooth headphones and main zone speakers.
Bluetooth Only:	Audio is output to Bluetooth headphones only.

Connected device

Displays the Bluetooth device connected to this unit.

Device List

- Available devices are displayed in the list once you start pairing mode on the Bluetooth headphones you want to connect. Select your Bluetooth headphones from the list to pair them.
- This unit can only pair with one Bluetooth headphone at a time. However, up to 8 Bluetooth headphones can be registered. Switch between registered devices from Device List in the "Bluetooth Transmitter" setup menu.
- To remove a saved Bluetooth device from the list, use the cursor Up/Down buttons to select it, then press the OPTION button and select "Forget This Device".



- "Output Mode" can also be set from "Bluetooth Transmitter" in the option menu.
- A2DP profile-compatible Bluetooth speakers can be connected following the same steps used to connect Bluetooth headphones.

NOTE

- Bluetooth transmitter and Bluetooth receiver function cannot be used at the same time. Settings in this menu are not available when listening to music on a Bluetooth device in any zone.
- Even when "Transmitter" is set to "On", press Bluetooth on the remote control to select the "Bluetooth" source and enable the Bluetooth receiver function. To listen to music stored on Bluetooth devices such as smartphones on this unit, press Bluetooth on the remote control to switch the input source to Bluetooth, then reconnect the Bluetooth device.
- Menu settings for Bluetooth Transmitter are not available when this unit is grouped within the HEOS App.



ZONE2 Setup / ZONE3 Setup

Makes settings for audio playback with ZONE2 and ZONE3.



- Values set for “Volume Limit” and “Power On Volume” are displayed according to the setting specified for the volume “Scale”. (🔗 p. 180)

■ Bass

Adjust bass.

-10dB – +10dB (Default : 0dB)

■ Treble

Adjust treble.

-10dB – +10dB (Default : 0dB)

■ High Pass Filter

Make settings for cutting the low range to reduce distortion in the bass.

On: The low range is attenuated.

Off
(Default): The low range is not attenuated.

■ L Ch Level

Adjust the left channel output level.

-12 dB – +12 dB (Default : 0 dB)

■ R Ch Level

Adjust the right channel output level.

-12 dB – +12 dB (Default : 0 dB)

■ Channel

Set whether to playback in stereo or monaural.

Stereo
(Default): Stereo playback.

Mono: Monaural playback.



■ HDMI Audio (ZONE2 only)

Selects the audio signal format for playing an HDMI source in ZONE2.

Through
(Default): The HDMI audio signal is passed through this unit to the device in ZONE2.

PCM: The HDMI audio signal input into this unit is converted to a PCM signal that can be output from the ZONE2 PRE OUT connectors or speaker terminals.*

* When the same input source is set for both MAIN ZONE and ZONE2, PCM 2-channel is used for the audio in MAIN ZONE too. However, it may not be possible to convert the signal from some playback devices to a PCM signal using this setting.

■ Volume Level

Set the volume output level.

Variable
(Default): Volume can be adjusted.

1 – 98
(–79 dB – 18 dB): Volume is fixed at the desired level. The volume cannot be adjusting using the remote control unit.



- The dB value is displayed when the “Scale” setting is “–79.5 dB – 18.0 dB”. (🔗 p. 180)

■ Volume Limit

Make a setting for maximum volume.

60 – 80 (–20 dB – 0 dB)
(Default : 70 (-10 dB))

Off: Do not set a maximum volume.



- This can be set when “Volume Level” is set to “Variable”. (🔗 p. 258)
- The dB value is displayed when the “Scale” setting is “–79.5 dB – 18.0 dB”. (🔗 p. 180)

■ Power On Volume

Sets the initial volume level when the power is turned on.

Last
(Default): Sets the power-on level to the last-used volume level.

Mute: Sets the power-on level to mute level.

1 – 98
(–79 dB – 18 dB): Sets a specific power-on level.



- This can be set when “Volume Level” is set to “Variable”. (🔗 p. 258)
- The dB value is displayed when the “Scale” setting is “–79.5 dB – 18.0 dB”. (🔗 p. 180)



■ Mute Level

Set the amount of attenuation when mute is on.

Full (Default):	Sets the mute level to full mute (no sound).
-40 dB :	Sets the mute level to 40 dB lower than the current volume level.
-20 dB :	Sets the mute level to 20 dB lower than the current volume level.

Zone Rename

Change the display title of each zone to one you prefer.

MAIN ZONE / ZONE2 / ZONE3

Set Defaults: The default setting is restored for the edited zone name.



- Up to 10 characters can be input.

Quick Select Names

Change the quick select name that appears on the TV screen to one you prefer.

Quick Select 1 / Quick Select 2 / Quick Select 3 / Quick Select 4

Set Defaults: The default setting is restored for the edited quick select name.



- Up to 16 characters can be input.



Trigger Out 1 / Trigger Out 2

Select the conditions for activating trigger out.

For details about how to connect the TRIGGER OUT jacks, see “TRIGGER OUT jacks” (👉 p. 82).

❑ When setting for zone (MAIN ZONE / ZONE2 / ZONE3)

Trigger out is activated through linkage to the power of the zone set to “On”.

❑ When setting for input source

Activate trigger out when the input source set to “On” is selected.

❑ When setting for HDMI monitor

Activate trigger out when the HDMI monitor set to “On” is selected.

On:	Activate trigger on this mode.
---:	Do not activate trigger on this mode.

Front Display

Makes settings related to the display on this unit.

■ Brightness

Adjust the display brightness of this unit.

Bright (Default):	Normal display brightness.
Dim:	Reduced display brightness.
Dark:	Very low display brightness.
Off:	Turns the display off.



- You can also adjust the display by pressing DIMMER on the main unit.



■ Channel Indicator

Sets whether to use the input signal display or output signal display for the channel indication on the display.

Input:	Uses the input signal display for the channel indication on the display.
Output (Default):	Uses the output signal display for the channel indication on the display.

Firmware

Checks for the latest firmware information about updates and updates the firmware.

■ Check for Update

Check for firmware updates.

The firmware can be updated if a firmware update has been released.

Update Now:	Execute the update process. When the update starts, the menu screen is shut down. During the update, the progress is shown on the display.
Update Later:	Update later.



- This unit automatically retries updating if updating fails. If an update still cannot be performed, an "Update Error" message appears in the display. See "Troubleshooting" – "Update error messages" for information on update error messages. (🔍 p. 294)
Check the conditions according to the message and try the update again.
- This menu cannot be selected when "Allow Update" is set to "Off".



■ Auto-Update

Turns on Automatic Updates so that feature updates are automatically downloaded and installed when this unit is in standby mode.

□ Auto-Update

This unit will automatically update to the newest firmware when in standby mode.

On: Turns on Automatic Updates.

Off
(Default): Turns off Automatic Updates.

□ Time Zone

Change the time zone.

Set the time zone that matches the area where you live.



- This menu cannot be selected when "Allow Update" is set to "Off".

■ Allow Update

Enable or disable updates for this unit.

On
(Default): Enables this unit to receive updates.

Off: Prevents this unit from receiving update.



- This setting causes Incompatibilities between this unit and HEOS App.



Notes concerning use of “Update” and “Add New Feature”

- In order to use these functions, you must have the correct system requirements and settings for an Internet connection. (👉 p. 79)
- Do not turn off the power until updating is completed.
- Approximately 1 hour is required for the updating procedure to be completed.
- If the update fails, press and hold the ⏻ on the main unit for more than 5 seconds, or remove and re-insert the power cord. After about 1 minute, “Please wait” appears on the display and update restarts. If the error continues, check the network environment.

Information

Show information about this unit settings, input signals, etc.

■ Audio

Show the audio information for MAIN ZONE.

Sound Mode:	The currently set sound mode.
Input Signal:	The input signal type.
Format:	The number of input signal channels (presence of front, surround, LFE).
Sample Rate:	The input signal's sampling frequency.
Offset:	The dialogue normalization correction value.
Flag:	This is displayed when inputting signals including a surround back channel. “MATRIX” is displayed with DTS-ES Matrix input signals, “DISCRETE” with DTS-ES Discrete signals.



■ Video

Show the HDMI input/output signals and HDMI monitor information for MAIN ZONE.

HDMI Signal Info.

Resolution / HDR / Color Space / Pixel Depth / ALLM / QFT / FRL Rate

HDMI Monitor 1 / HDMI Monitor 2

Interface / HDR / Resolutions / Enhanced Features / Max FRL Rate



- A or B may be displayed at the end of resolution. A represents uncompressed video and B represents compressed video.
- Refer to “About HDMI” for more information about ALLM, QFT and FRL. (👉 p. 300)

■ ZONE

Show information about current settings.

MAIN ZONE:	This item shows information about settings for MAIN ZONE. The information displayed differs according to the input source.
ZONE2/3:	This item shows information about settings for ZONE2 and ZONE3.

■ Firmware

Version:	Displays information for the current firmware.
DTS Version:	Displays the current DTS version.

■ Notifications

Displays and sets notifications.

Also, sets whether or not to display the notification when the power is turned on.

Notification Alerts

On (Default):	Notification messages are displayed.
Off:	Notification messages are not displayed.



- Pressing INFO on the remote control switches the display to show information such as the input source name, the volume, the sound mode name, the video input/output signals, and other information. The FRL Rate is displayed when the “4K/8K Signal Format” setting of this unit is “8K Enhanced” and the connected TV supports FRL transmission mode.



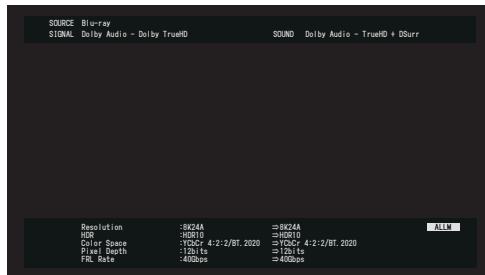
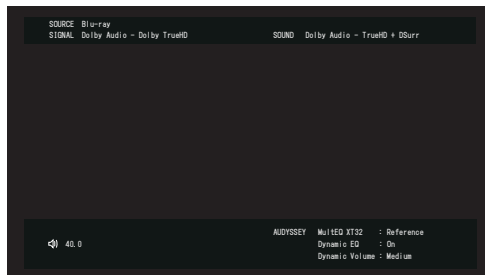

Usage Data

To help us improve our products and customer service, Denon collects anonymous information about how you use this unit (such as frequently used input sources and sound modes and speaker settings).

Denon will never provide any information we collect to third parties.

Yes:

Provide information on the operating status of this unit.

No:

Do not provide information on the operating status of this unit.



Save & Load

Save and restore device settings by using a USB memory device.



- Use a USB memory device that has at least 128 MB of free space and is formatted to FAT32. Data may not Save/Load correctly to some USB memory devices.
- It may take up to 10 minutes for data to Save/Load. Do not turn off the power until the process is complete.

■ Save Configuration

Current unit settings are stored on the USB memory device.

When the settings are saved correctly, “Saved” appears on the display and the file “config.avr” is created on the USB memory device.



- Do not change the file name of the created file. Doing so will prevent the file from being recognized as a settings file when restoring.

■ Load Configuration

Settings saved on the USB memory device are restored.

When the saved settings are restored correctly, “Loaded” appears on the display and the unit automatically restarts.

Setup Lock

Protect settings from inadvertent changes.

■ Lock

On: Turn protection on.

Off (Default): Turn protection off.



- When cancelling the setting, set “Lock” to “Off”.

NOTE

- When “Lock” is set to “On”, no setting items are displayed except for “Setup Lock”.



Reset

Returns settings to the factory default.

Initialization can be performed for all unit settings or for Network settings only.

■ All Settings

All settings are reset to the factory default values.

■ Network Settings

Only network settings are reset to the factory default values.



- Before returning the settings to the default settings, use the “Save & Load” function from the menu to save and restore the details of various settings configured on the unit. (🔗 p. 266)
- The “Reset” operation can also be performed by using the button on the main unit. For details on resetting all of the settings to the factory defaults see “Resetting factory settings” (🔗 p. 295), and for details on resetting the network settings to the factory defaults see “Resetting network settings” (🔗 p. 296).

NOTE

- Do not disconnect the power or turn the device off during network settings initialization.



Setting the back light of the remote control unit

You can turn off the backlight of the remote control unit.

- Backlight is set on in the factory settings.

Disabling the backlight

- 1 Press and hold both **SETUP** and **Light** button until the **MAIN**, **ZONE2** and **ZONE3** indicators on the remote are flashing green, then release.



- The backlight function can be turned on by performing step 1 again while the backlight function is off.

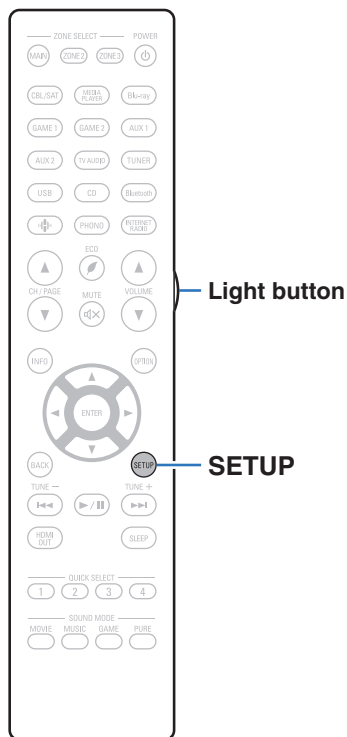

Specifying the zone used with the remote control unit

To prevent accidental misuse, you can set the zone for which the remote control unit is used.

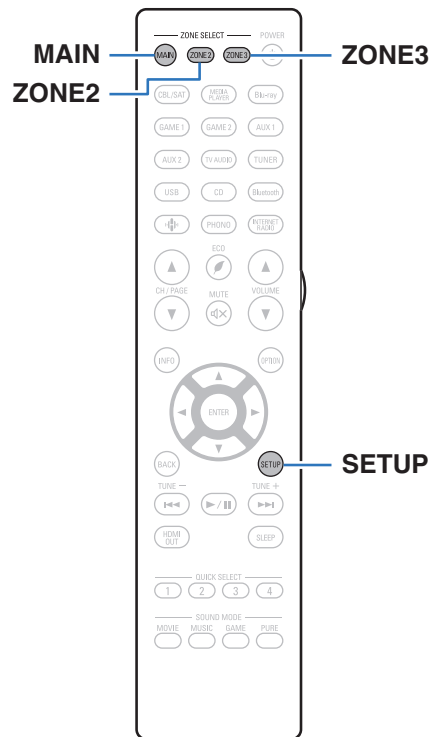

- 1 Press and hold down either **MAIN**, **ZONE2** or **ZONE3** and **SETUP** at the same time until the **MAIN**, **ZONE2** and **ZONE3** buttons blink.

MAIN:	When only using MAIN ZONE
ZONE2:	When using MAIN ZONE and ZONE2
ZONE3 (Default):	When using MAIN ZONE, ZONE2 and ZONE3



■ Contents

Tips

I want the volume not to become too loud by mistake	271
I want to keep the volume at the same level when I turn the power on	271
I want to have the subwoofer always output audio	271
I want to make human voices in the movies clearer	271
I want to keep bass and clarity during playback at a lower volume level	271
I want to automatically adjust the volume level difference in content such as TV and movies	271
I want to set the optimized listening environment after changing the configuration/position of the speakers or changing a speaker to a new one	272
I want to combine a desired video with the current music	272
I want to skip unused input sources	272
I want to enjoy the same music in all zones at the home party, etc.	272
I want to minimize the delay in video signals when I'm playing a game on my game console	272

Troubleshooting

Power does not turn on / Power is turned off	274
Operations cannot be performed through the remote control unit	275
Display on this unit shows nothing	275
No sound comes out	276
Desired sound does not come out	277
Sound is interrupted or noise occurs	281
No video is shown on the TV	282
The menu screen is not displayed on the TV	284
The color of the menu screen and operations content displayed on the television is different from normal	284
AirPlay cannot be played back	285
USB memory devices cannot be played back	286
Bluetooth cannot be played back	287
The Internet radio cannot be played back	289
Music files on PC or NAS cannot be played back	290
Various online services cannot be played	291
The HDMI Control function does not work	291
Cannot connect to a wireless LAN network	292
When using HDMI ZONE2, the devices does not function properly	293
Update error messages	294



Tips

I want the volume not to become too loud by mistake

- Set the volume upper limit for “Volume Limit” in the menu beforehand. This prevents children or others from increasing the volume too much by mistake. You can set this for each zone. (“Volume” (🔊 p. 180), “Volume Limit” (🔊 p. 258))

I want to keep the volume at the same level when I turn the power on

- By default, the volume setting when power was previously set to standby on this unit is applied at next power on with no change. To use a fixed volume level, set the volume level at power on for “Power On Volume” in the menu. You can set this for each zone. (“Volume” (🔊 p. 180), “Power On Volume” (🔊 p. 258))

I want to have the subwoofer always output audio

- Depending on the input signals and sound mode, the subwoofer may not output audio. When “Subwoofer Output” in the menu is set to “LFE + Main”, you can have the subwoofer always output audio. (🔊 p. 236)

I want to make human voices in the movies clearer

- Select a setting that makes the dialog easier to hear in the option menu “Dialog Enhancer”. (🔊 p. 119)

I want to keep bass and clarity during playback at a lower volume level

- Set “Dynamic EQ” in the menu to “On”. This setting corrects the frequency characteristics to allow you to enjoy clear sound without the bass being lost even during playback at a lower volume level. (🔊 p. 182)

I want to automatically adjust the volume level difference in content such as TV and movies

- Set “Dynamic Volume” in the menu. Volume level changes (between quiet scenes and loud scenes) in TV shows or movies are automatically adjusted to your desired level. (🔊 p. 183)



I want to set the optimized listening environment after changing the configuration/position of the speakers or changing a speaker to a new one

- Perform Audyssey® Setup. This automatically makes the optimized speaker settings for the new listening environment. (👉 p. 202)

I want to combine a desired video with the current music

- Set “Video Select” in the option menu to “On”. You can combine the current music with your desired video source from a Set-top Box or Blu-ray, etc. while listening to music from the CD, Phono, HEOS Music, USB or Bluetooth. (👉 p. 124)

I want to skip unused input sources

- Set unused input sources for “Hide Sources” in the menu. This allows you to skip unused input sources when turning the SOURCE SELECT knob on this unit. (👉 p. 200)

I want to enjoy the same music in all zones at the home party, etc.

- Set “All Zone Stereo” in the option menu to “Start”. You can simultaneously play back music in another room (ZONE2, ZONE3) that is played back in MAIN ZONE. (👉 p. 125)

I want to minimize the delay in video signals when I'm playing a game on my game console

- When the video is delayed against button operations with the controller on the game console, set “Video Mode” in the menu to “Game”. (👉 p. 191)



Troubleshooting

If a problem should arise, first check the following:

1. **Are the connections correct?**
2. **Is the set being operated as described in the owner's manual?**
3. **Are the other devices operating properly?**



- If steps 1 to 3 above do not improve the problem, restarting the device may improve the problem. Continue pressing the  button on the unit until "Restart" appears in the display, or remove and re-insert the power cord of the unit.

If this unit does not operate properly, check the corresponding symptoms in this section.

If the symptoms do not match any of those described here, consult your dealer as it could be due to a fault in this unit. In this case, disconnect the power immediately and contact the store where you purchased this unit.



Power does not turn on / Power is turned off

Power does not turn on.

- Check whether the power plug is correctly inserted into the power outlet. (🔍 p. 83)

Power automatically turns off.

- The sleep timer is set. Turn on the power again. (🔍 p. 142)
- “Auto Standby” is set. “Auto Standby” is triggered when there is no operation for a set amount of time. To disable “Auto Standby”, set “Auto Standby” on the menu to “Off”. (🔍 p. 255)

Power turns off and the power indicator flashes in red approx. every 2 seconds.

- The protection circuit has been activated due to a rise in temperature within this unit. Turn the power off, wait about an hour until this unit cools down sufficiently, and then turn the power on again. (🔍 p. 327)
- Please re-install this unit in a place having good ventilation.

Power turns off and the power indicator flashes in red approx. every 0.5 seconds.

- Check the speaker connections. The protection circuit may have been activated because speaker cable core wires came in contact with each other or a core wire was disconnected from the connector and came in contact with the rear panel of this unit. After unplugging the power cord, take corrective action such as firmly re-twisting the core wire or taking care of the connector, and then reconnect the wire. (🔍 p. 38)
- Turn down the volume and turn on the power again. (🔍 p. 85)
- This unit’s amplifier circuit has failed. Unplug the power cord and contact our customer service center.

The power to this unit does not turn off when you press the Power operation button. “ZONE2 On” or “ZONE3 On” appears on the display.

- Power in either ZONE2 or ZONE3 is on. To turn off the power of the device (standby), press either the ZONE2 ON/OFF or ZONE3 ON/OFF button on the main unit or press the POWER ⏻ button after pressing the Z2 or Z3 button on the remote control unit.



Operations cannot be performed through the remote control unit

Operations cannot be performed through the remote control unit.

- Batteries are worn out. Replace with new batteries. (🔧 p. 9)
- Operate the remote control unit within a distance of about 7 m from this unit and at an angle of within 30°. (🔧 p. 9)
- Remove any obstacle between this unit and the remote control unit.
- Insert the batteries in the proper direction, checking the ⊕ and ⊖ marks. (🔧 p. 9)
- The set's remote control sensor is exposed to strong light (direct sunlight, inverter type fluorescent bulb light, etc.). Move the set to a place in which the remote control sensor will not be exposed to strong light.
- The operation target zone does not correspond to the zone setting specified on the remote control unit. Press MAIN, Z2 or Z3 to select the zone to operate. (🔧 p. 169)
- When using a 3D video device, the remote control unit of this unit may not function due to effects of infrared communications between units (such as TV and glasses for 3D viewing). In this case, adjust the direction of units with the 3D communications function and their distance to ensure they do not affect operations from the remote control unit of this unit.
- “ECO Mode” cannot be switched using ECO  on the remote control unit when the following settings are used. (🔧 p. 252)
 - When “Amp Assign” is set to “Preamplifier” (🔧 p. 215)
 - When speaker impedance is set to 4 Ω/ohms (🔧 p. 38)

Display on this unit shows nothing

Display is off.

- Set “Brightness” on the menu to something other than “Off”. (🔧 p. 260)
- When the sound mode is set to “Pure Direct”, the display is off. (🔧 p. 130)



No sound comes out

No sound comes out of speakers.

- Check the connections for all devices. (👉 p. 38)
- Insert connection cables all the way in.
- Check that input connectors and output connectors are not reversely connected.
- Check cables for damage.
- Check that speaker cables are properly connected. Check that cable core wires come in contact with the metal part on speaker terminals. (👉 p. 38)
- Securely tighten the speaker terminals. Check speaker terminals for looseness. (👉 p. 38)
- Check that a proper input source is selected. (👉 p. 85)
- Adjust the volume. (👉 p. 86)
- Cancel the mute mode. (👉 p. 86)
- Check the digital audio input connector setting. (👉 p. 197)
- Check the digital audio output setting on the connected device. On some devices, the digital audio output is set to off by default.
- When a headphone is plugged into the PHONES jack on the main unit, sound is not output from the speaker terminal and PRE OUT connector.
- Audio is output to your Bluetooth headphones, but not to speakers or pre-outs when “Output Mode” set to “Bluetooth Only”. Change “Output Mode” to “Bluetooth + Speakers” to output audio from your Bluetooth headphones as well as your speakers or pre-outs. (👉 p. 256)

No sound comes out when using the DVI-D connection.

- When this unit is connected to a device equipped with a DVI-D connector, no sound is output. Make a separate audio connection.

No sound comes out when selecting Tuner input.

- This unit does not have built-in FM/AM tuner. Connect an external tuner to the TUNER inputs.



Desired sound does not come out

The volume does not increase.

- The maximum volume is set too low. Set the maximum volume using “Limit” on the menu. (👉 p. 180)
- Appropriate volume correction processing is performed according to the input audio format and settings, so the volume may not reach the upper limit.

The volume of Bluetooth headphones does not decrease.

- Bluetooth headphones volume cannot be adjusted from this unit. Use a Bluetooth headphones with volume adjustment.

No sound comes out with the HDMI connection.

- Check the connection of the HDMI connectors. (👉 p. 70)
- When outputting HDMI audio from the speakers, set “HDMI Audio Out” on the menu to “AVR”. To output from the TV, set “TV”. (👉 p. 186)
- When using the HDMI Control function, check that the audio output is set to the AV amplifier on the TV. (👉 p. 141)

When an eARC function-compatible television is connected, television audio is not output from the speaker connected to this unit

- eARC function settings may be required depending on the eARC function-compatible television you are using. Make sure eARC is set to on if this setting exists on your television. For more information, check your television’s owner’s manual.
- Make sure the input source of this unit is “TV Audio”.
- The eARC function does not operate when the HDMI input connector is set to the “TV Audio” input source. To enable eARC function operation, remove the HDMI input connector setting, then restart this unit and the television. (👉 p. 198)



No sound comes out of a specific speaker.

- Check that speaker cables are properly connected.
- Check that a selection other than “None” is set for the “Speaker Configuration” setting in menu. (🔍 p. 225)
- Check the “Assign Mode” setting in the menu. (🔍 p. 213)
- When the sound mode is “Stereo” and “Virtual”, audio is only output from the front speakers and subwoofer.
- Audio is not output from the surround back speaker if “Speaker Virtualizer” is set to “On” when “Speaker Configuration” - “Surround Back” is set to “1 spkr” in the menu. (🔍 p. 173)
- Audio is not output from the front wide speaker if “Speaker Virtualizer” is set to “On”. (🔍 p. 173)
- When “Speaker Configuration” - “Surround Back” is set to “2 spkrs”, “Speaker Configuration” - “Center” is set to “Large” or “Small”, and sound mode is set to “IMAX DTS”, surround audio is output from the surround back speaker. Audio is not output from the surround speaker. (🔍 p. 229)

No sound is produced from subwoofer.

- Check the subwoofer connections.
- Turn on the subwoofer’s power.
- Set “Speaker Configuration” - “Subwoofer” in the menu to “1 spkr”, “2 spkrs”, “3 spkrs” or “4 spkrs”. (🔍 p. 225)
- When “Speaker Configuration” - “Front” in the menu is set to “Large”, depending on the input signal and the sound mode, no sound may be output from the subwoofer. (🔍 p. 225)
- When no subwoofer audio signal (LFE) is included in the input signals, no sound may be output from the subwoofer. (🔍 p. 236)
- You can make the subwoofer always output sound by setting the “Subwoofer Output” to “LFE + Main”. (🔍 p. 236)

DTS sound is not output.

- Check that the digital audio output setting on the connected device is set to “DTS”.

Dolby Atmos, Dolby TrueHD, DTS-HD, Dolby Digital Plus audio is not output.

- Make HDMI connections. (🔍 p. 73)
- Check the digital audio output setting on the connected device. On some devices, “PCM” is set by default.



DTS Neural:X mode cannot be selected.

- DTS Neural:X cannot be selected when using the headphones.

Dolby Surround mode cannot be selected.

- Dolby Surround cannot be selected when using the headphones.

IMAX DTS:X cannot be selected.

- IMAX DTS:X and IMAX DTS cannot be selected but DTS:X and DTS can be selected, when the headphones are used.

Sound modes other than “Stereo” or “Direct” cannot be selected.

- Only “Stereo” or “Direct” can be selected for the sound mode if Headphone:X signals are input.

Audyssey MultEQ® XT32, Audyssey Dynamic EQ®, Audyssey Dynamic Volume® and Audyssey LFC™ cannot be selected.

- These cannot be selected when you have not performed Audyssey® Setup. (👉 p. 202)
- Switch to a sound mode other than “Direct” or “Pure Direct”. (👉 p. 129)
- Audyssey Dynamic EQ®, Audyssey Dynamic Volume® and Audyssey LFC™ cannot be selected when sound mode is “DTS Virtual:X” or sound mode that have “+ Virtual:X” in the sound mode name.
- These cannot be selected when using the headphones.

“Restorer” cannot be selected.

- Check that an analog signal or PCM signal (Sample Rate = 44.1/48 kHz) is input. For playback of multichannel signals such as Dolby Digital or DTS surround, “Restorer” cannot be used. (👉 p. 179)
- Switch to a sound mode other than “Direct” or “Pure Direct”. (👉 p. 129)



No audio is output from PRE OUT or speakers for ZONE2/ZONE3.

- In ZONE2/ZONE3, the audio can be played back when signals input from digital connectors (OPTICAL/COAXIAL) are in 2ch PCM format.
- In ZONE2, the audio can be played back when signals input from the HDMI connector are in 2ch PCM format. To play back the audio in ZONE2 irrespective of the input signal format, set "HDMI Audio" in the menu to "PCM". Depending on the played back device, the audio may not be played back even with this setting. In that case, set the audio format to "PCM (2ch)" on the played back device. (👉 p. 258)
- When listening to audio from a Bluetooth device in ZONE2/ZONE3, remove any obstructions between the Bluetooth device and this unit and use it within a range of about 30 m.

Sound mode settings are not available when using Bluetooth headphones. Audio menu settings are also not available.

- This unit cannot change sound mode or audio menu settings for audio output to Bluetooth headphones.



Sound is interrupted or noise occurs

During playback from the Internet radio or USB memory device, sound is occasionally interrupted.

- When the transfer speed of the USB memory device is slow, sound may occasionally be interrupted.
- The network communication speed is slow or the radio station is busy.

When making a call on iPhone, noise occurs in audio output on this unit.

- When making a call, keep a distance of 20 cm or longer between iPhone and this unit.

The sounds appear to be distorted.

- Lower the volume. (🔊 p. 86)
- Set "Off" to the "ECO Mode". When "On" or "Auto" is in the "ECO Mode", the audio may be distorted when the playback volume is high. (🔊 p. 252)

Sound cuts out when using Wi-Fi connection.

- The frequency band used by the wireless LAN is also used by microwave ovens, cordless telephones, wireless game controllers and other wireless LAN devices. Using such devices at the same time as this unit may cause sound to cut out due to electronic interference. Sound cut out can be improved using the following methods. (🔊 p. 79)
 - Install devices that cause interference away from this unit.
 - Turn off the power supply to devices that cause interference.
 - Change the settings of the router channel to which this unit is connected to. (See the instruction manual of the wireless router for details on how to change the channel.)
 - Switch to a wired LAN connection.
- Particularly when you play back large music files, depending on your wireless LAN environment, the playback sound may be interrupted. In this case, make the wired LAN connection. (🔊 p. 244)



No video is shown on the TV

No picture appears.

- Check the connections for all devices. (👉 p. 70)
- Insert connection cables all the way in.
- Check that input connectors and output connectors are not reversely connected.
- Check cables for damage.
- Match the input settings to the input connector of the TV connected to this unit. (👉 p. 197)
- Check that the proper input source is selected. (👉 p. 85)
- Check the video input connector setting. (👉 p. 197)
- Check that the resolution of the player corresponds to that of the TV. (👉 p. 264)
- Check whether the TV is compatible with copyright protection (HDCP). If connected to a device not compatible with HDCP, video will not be output correctly. (👉 p. 301)
- To enjoy content that is copyright protected by HDCP 2.2 or HDCP 2.3, use a playback device and TV compatible with HDCP 2.2 or HDCP 2.3.
- The HDMI signal cannot be converted to an analog signal. (👉 p. 302)
- To play back a 4K video, use a “High Speed HDMI Cable” or an “High Speed HDMI Cable with Ethernet”. In order to achieve a higher fidelity for 4K videos, it is recommended to use a “Premium High Speed HDMI Cables” or an “Premium High Speed HDMI Cables with Ethernet” that has an HDMI Premium Certified Cable label on the product package.
- Use a certified “Ultra High Speed HDMI cable” to enjoy 8K or 4K 120Hz video. If you use a different HDMI cable, the video may not display or other problems may occur.

No video is shown on the TV with the DVI-D connection.

- With the DVI-D connection, on some device combinations, devices may not function properly due to the copy guard copyright protection (HDCP). (👉 p. 301)



While the menu is being displayed, no video is shown on the TV.

- The video being played will not appear in the background of the menu when the menu is operated.

When using HDMI ZONE2, the video output in MAIN ZONE is interrupted.

- When ZONE2 is operated with the same input source selected for MAIN ZONE and ZONE2, video in MAIN ZONE may be interrupted.



The menu screen is not displayed on the TV

The menu screen or status information screen is not displayed on the TV.

- The status information will not appear on the TV when the following video signals are being played.
 - Some images of 3D video content
 - Computer resolution images (example: VGA)
 - Video with an aspect ratio other than 16:9 or 4:3
 - Some kind of HDR signals
 - Some kind of game contents
 - Compressed video
- When a 2D video is converted to a 3D video on the TV, the menu screen or status information screen is not displayed properly. (👉 p. 264)
- In the pure direct playback mode, the menu screen or status information is not displayed. Switch to a sound mode other than the pure direct mode. (👉 p. 128)
- Set the “TV Format” setting in the menu to a selection that is appropriate for the TV. (👉 p. 196)

The color of the menu screen and operations content displayed on the television is different from normal

The color of the menu screen and operations content displayed on the television is different.

- Performing operations on this unit during playback of a Dolby Vision signal may cause variance in the color display of the menu screen and operations content. This is a characteristic of the Dolby Vision signal and is not a malfunction.



AirPlay cannot be played back

The AirPlay icon is not displayed on iTunes / iPhone / iPod touch / iPad.

- This unit and PC / iPhone / iPod touch / iPad are not connected to the same network (LAN). Connect it to the same LAN as this unit. (👉 p. 79)
- The firmware on iTunes / iPhone / iPod touch / iPad is not compatible with AirPlay. Update the firmware to the latest version.

Audio is not output.

- The volume on iTunes / iPhone / iPod touch / iPad is set to the minimum level. The volume on iTunes / iPhone / iPod touch / iPad is linked with the volume on this unit. Set a proper volume level.
- The AirPlay playback is not performed, or this unit is not selected. Click the AirPlay icon on the iTunes / iPhone / iPod touch / iPad screen and select this unit. (👉 p. 114)

Audio is interrupted during the AirPlay playback on iPhone / iPod touch / iPad.

- Quit the application running in the background of the iPhone/iPod touch/iPad, and then play using AirPlay.
- Some external factors may be affecting the wireless connection. Modify the network environment by taking measures such as shortening the distance from the wireless LAN access point.

iTunes cannot be played back through the remote control unit.

- Enable the “Allow iTunes audio control from remote speakers” setting on iTunes. Then, you can perform playback, pause, and skip operations through the remote control unit.



USB memory devices cannot be played back

USB memory device is not recognized.

- Disconnect and reconnect the USB memory device. (👉 p. 78)
- Mass storage class compatible USB memory devices are supported.
- This unit does not support a connection through a USB hub. Connect the USB memory device directly to the USB port.
- The USB memory device must be formatted to “FAT32” or “NTFS”.
- Not all USB memory devices are guaranteed to work. Some USB memory devices are not recognized. When using a type of portable hard disc drive compatible with the USB connection that requires power from an AC adapter, use the AC adapter that came with the drive.

Files on the USB memory device are not displayed.

- Files of a type not supported by this unit are not displayed. (👉 p. 87)
- This unit is able to display files in a maximum of eight folder layers. A maximum of 5000 files (folders) can also be displayed for each layer. Modify the folder structure of the USB memory device.
- When multiple partitions exist on the USB memory device, only files on the first partition are displayed.

iOS and Android devices are not recognized.

- The USB port of this unit does not support playback from iOS and Android devices.

Files on a USB memory device cannot be played.

- Files are created in a format that is not supported by this unit. Check the formats supported by this unit. (👉 p. 304)
- You are attempting to play a file that is copyright protected. Files that are copyright protected cannot be played on this unit.
- Playback may not be possible if the album art file size exceeds 2 MB.



Bluetooth cannot be played back

Bluetooth devices cannot be connected to this unit.

- The Bluetooth function in the Bluetooth device has not been enabled. See the Owner's Manual of the Bluetooth device to enable the Bluetooth function.
- Bring the Bluetooth device near to this unit.
- The Bluetooth device cannot connect with this unit if it is not compatible with the A2DP profile.
- Turn the power of the Bluetooth device off and on again, and then try again.

Smartphones and other Bluetooth devices cannot be connected.

- Smartphones and other Bluetooth devices cannot be connected when "Transmitter" is set to "On". Press Bluetooth on the remote control to switch the input source to Bluetooth, then connect the device. (🔑 p. 256)

Cannot connect Bluetooth headphones.

- Bring the Bluetooth headphones near to this unit.
- Turn the power of the Bluetooth headphones off and on again, and then try again.
- Go to "General" - "Bluetooth Transmitter", and set "Transmitter" to "On" within the menu. (🔑 p. 256)
- Make sure this unit is not already connected to another pair of Bluetooth headphones. Check the currently connected Bluetooth headphones by pressing INFO on the remote control or STATUS button on the unit. Disconnect the connected Bluetooth headphones before connecting the ones you want to use.
- Bluetooth headphones cannot be connected if Bluetooth is being used as an input source in any zone.
- Bluetooth headphones cannot be connected if this unit is grouped in the HEOS App. Remove this unit from the group to enable Bluetooth headphones connection.
- The Bluetooth headphones cannot connect with this unit if it is not compatible with the A2DP profile.
- Connection and operation are not guaranteed for all Bluetooth-enabled devices.
- This unit can only connect to one Bluetooth headphone at a time. However, up to 8 Bluetooth headphones can be registered. You can switch between registered devices from "Device List" in the "Bluetooth Transmitter" menu. (🔑 p. 256)



The sound is cut off.

- Bring the Bluetooth device near to this unit.
- Remove obstructions between the Bluetooth device and this unit.
- To prevent electromagnetic interference, locate this unit away from microwave ovens, wireless LAN devices and other Bluetooth devices.
- Reconnect the Bluetooth device.

The sound is cut off or noise occurs when using Bluetooth headphones.

- Move the Bluetooth headphones closer to this unit.
- Remove obstructions between the Bluetooth headphones and this unit.
- Reconnect the Bluetooth headphones.
- To prevent electromagnetic interference, locate this unit away from microwave ovens, wireless LAN devices and other Bluetooth devices.
- We recommend using wired LAN to connect this unit and other devices.
- Bluetooth transmits on the 2.4 GHz band which may interfere with Wi-Fi transmitted on this band. Connect this unit and other devices to Wi-Fi network on a 5 GHz band if available on your Wi-Fi router.

Audio is delayed on my Bluetooth headphones.

- This unit cannot adjust audio delay on Bluetooth headphones.



The Internet radio cannot be played back

A list of broadcasting stations is not displayed.

- The LAN cable is not properly connected, or the network is disconnected. Check the connection status. (👉 p. 79)
- Perform the network diagnostic mode.

Internet Radio cannot be played.

- The selected radio station is broadcasting in a format that is not supported by this unit. Formats that can be played back in this unit are MP3, WMA and AAC. (👉 p. 307)
- The firewall function is enabled on the router. Check the firewall setting.
- The IP address is not properly set. (👉 p. 246)
- Check the power of the router is on.
- To obtain the IP address automatically, enable the DHCP server function on the router. Also, set the DHCP setting to “On” on this unit. (👉 p. 246)
- To obtain the IP address manually, set the IP address on this unit. (👉 p. 246)
- Some radio stations broadcast silently during some time period. In this case, no audio is output. Wait for a while and select the same radio station, or select another radio station. (👉 p. 99)
- The selected radio station is not in service. Select a radio station in service.

Cannot connect to favorite radio stations.

- Radio station is not currently in service. Register radio stations in service.



Music files on PC or NAS cannot be played back

Files stored on a computer cannot be played.

- Files are stored in a non-compatible format. Record in a compatible format. (🔍 p. 306)
- Files that are copyright protected cannot be played on this unit.
- The USB port of this unit cannot be used for connection to a computer.
- Media sharing settings on the server or NAS do not allow this unit. Change the settings to allow this unit. For details, see the owner's manual of the server or NAS.

Server is not found, or it is not possible to connect to the server.

- The computer's or router's firewall is activated. Check the computer's or router's firewall settings.
- Computer's power is not turned on. Turn on the power.
- Server is not running. Launch the server.
- IP address of this unit is wrong. Check the IP address of this unit. (🔍 p. 243)

Music files on PC cannot be played back.

- Even if PC is connected to the USB port on this unit, music files on it cannot be played back. Connect PC to this unit through the network. (🔍 p. 79)

Files on PC or NAS are not displayed.

- Files of a type not supported by this unit are not displayed. (🔍 p. 306)

Music stored on a NAS cannot be played.

- If you use a NAS in conformity with the DLNA standard, enable the DLNA server function in the NAS setting.
- If you use a NAS that does not conform with the DLNA standard, play the music via a PC. Set Windows Media Player's media sharing function and add NAS to the selected play folder.
- If connection is restricted, set audio equipment as the connection target.



Various online services cannot be played

Various online services cannot be played.

- The online service may have been discontinued.

The HDMI Control function does not work

The HDMI Control function does not work.

- Check that "HDMI Control" in the menu is set to "On". (👉 p. 188)
- You cannot operate devices that are not compatible with the HDMI Control function. In addition, depending on the connected device or the settings, the HDMI Control function may not work. In this case, operate the external device directly. (👉 p. 141)
- Check that the HDMI Control function setting is enabled on all devices connected to this unit. (👉 p. 141)
- When you make connection related changes such as connecting an additional HDMI device, the link operation settings may be initialized. Turn off this unit and devices connected via HDMI, and turn them on again. (👉 p. 141)
- The HDMI MONITOR 2 connector is not compatible with the HDMI Control function. Use the HDMI MONITOR 1 connector to connect to the TV. (👉 p. 70)



Cannot connect to a wireless LAN network

Cannot connect to the network.

- The network name (SSID), password and encryption setting have not been set up correctly. Configure the network settings according to the setting details of this unit. (📖 p. 245)
- Shorten the distance from the wireless LAN access point and remove any obstructions to improve access first before re-connecting again. Place the unit away from microwave ovens and other network access points.
- Configure the access point channel settings away from channels that are being used by other networks.
- This unit is not compatible with WEP (TSN).

Cannot connect to a WPS Router.

- Check that the WPS mode of the router is operating.
- Press the WPS button on the router and then press the “Connect” button displayed on the TV within 2 minutes.
- A router/settings that are compatible with WPS 2.0 standards are required. Set the encryption type to “None”, “WPA-PSK (AES)” or WPA2-PSK (AES). (📖 p. 245)
- If the router encryption method is WEP/WPA-TKIP/WPA2-TKIP, you cannot connect by using the WPS button on the router. In this case, use the “Scan Networks” or “Manual” method to connect.

Cannot connect to the network using iPhone/iPod touch/iPad.

- Update the iPhone/iPod touch/iPad firmware to the latest version.
- When configuring the settings via a wireless connection, iOS 10.0.2 or later needs to be supported.



When using HDMI ZONE2, the devices does not function properly

When using MAIN ZONE, video output is interrupted in HDMI ZONE2.

- With the same input source selected for MAIN ZONE and ZONE2, when you operate MAIN ZONE, video may be interrupted in HDMI ZONE2.

When using HDMI ZONE2, no video or audio is output from the TV in ZONE2.

- Check that the power is on for ZONE2. (👉 p. 161)
- Check the input source for ZONE2. (👉 p. 161)
- In ZONE2, playback is only possible when the input signals are HDMI signals.
- When the TV does not support the input audio format, audio is not output. Set the audio format to “PCM” on the playback device. Alternatively, set “ZONE2 Setup” - “HDMI Audio” in the menu to “PCM”. (👉 p. 258)
- When the TV is not compatible with the resolution of the input video, no video is output. Set the output resolution on the playback device to a resolution that is compatible with the TV.

When using HDMI ZONE2, MAIN ZONE audio is played back as PCM.

- When the same input source is selected for MAIN ZONE and ZONE2, the audio format is limited according to the specifications of the TV in ZONE2.



Update error messages

If an update is interrupted or fails, an error message appears.

Display	Description
Connection failed. Please check your network, then try again.	The network connection is unstable. Connection to the server failed. Check your network environment and try the update again.
Update failed. Please check your network, then try again.	The download of the firmware failed. Check your network environment and try the update again.
Please check your network, unplug and reconnect the power cord, and try again.	The update failed. Press and hold the  on the main unit for more than 5 seconds, or remove and re-insert the power cord. The update restarts automatically.
Please contact customer service in your area.	This unit may be broken. Contact our Customer Service Center in your area.



Resetting factory settings

If the indicators are incorrect or the unit cannot be operated, restarting the unit may improve the problem. We recommend restarting the unit before returning the settings to the default settings. (☞ p. 273)

If the operations are not improved by restarting the unit, follow the steps below.

Various settings are reset to the factory default values. Make settings again.

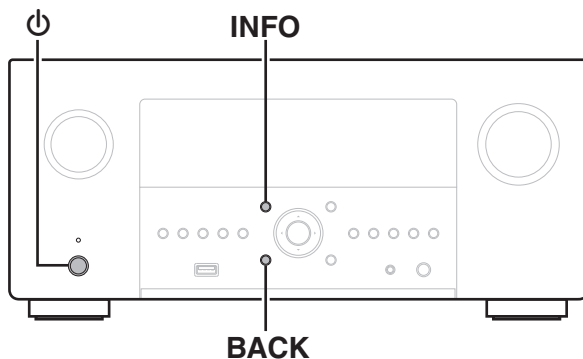

- 1 Turn off the power using ⏻ .**
- 2 Press ⏻ while simultaneously pressing INFO and BACK.**
- 3 Remove your fingers from the two buttons when “Initialized” appears on the display.**



- Before returning the settings to the default settings, use the “Save & Load” function from the menu to save and restore the details of various settings configured on the unit. (☞ p. 266)
- You can also reset all settings to the factory defaults using “Reset” - “All Settings” in the menu. (☞ p. 267)



Resetting network settings

If network contents cannot be played or the unit cannot connect to the network, restarting the unit may improve the problem. We recommend restarting the unit before returning the settings to the default settings. (🔗 p. 273)

If the operations are not improved by restarting the unit, follow the steps below.

Network settings are reset to the factory default values. Make settings again.

However, the menu “Amp Assign”, “Speaker Configuration” and “Video” settings are not reset.

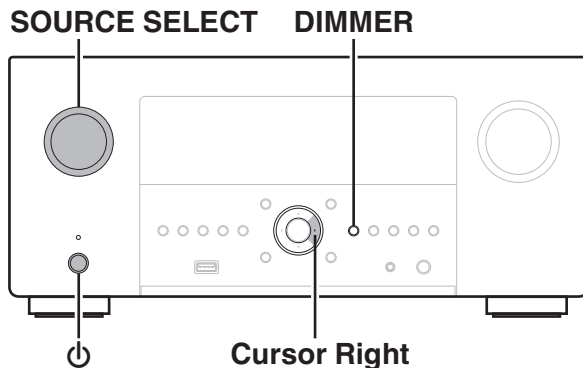

- 1 Press  to turn on power to the unit.
- 2 Turn SOURCE SELECT to select “HEOS Music”.
- 3 Press and hold the main unit’s DIMMER and cursor Right at the same time for at least 3 seconds.
- 4 Remove your fingers from the two buttons when “Network Reset...” appears on the display.
- 5 “Completed” is shown in the display when reset is complete.



- Before returning the settings to the default settings, use the “Save & Load” function from the menu to save and restore the details of various settings configured on the unit. (🔗 p. 266)
- You can also reset the network settings to the factory defaults using “Reset” - “Network Settings” in the menu. (🔗 p. 267)

NOTE

- Do not turn the power off until reset is complete.



Restoring the firmware to the factory defaults

When the unit or the network functions do not work properly, operation may be improved by restoring the firmware to the factory defaults.

Do this when the unit still does not work properly even after trying the steps for “Resetting factory settings” or “Resetting network settings”. (☞ p. 295, 296)

After the firmware is restored, various settings are reset to the default settings. Configure the network settings and update the firmware again.

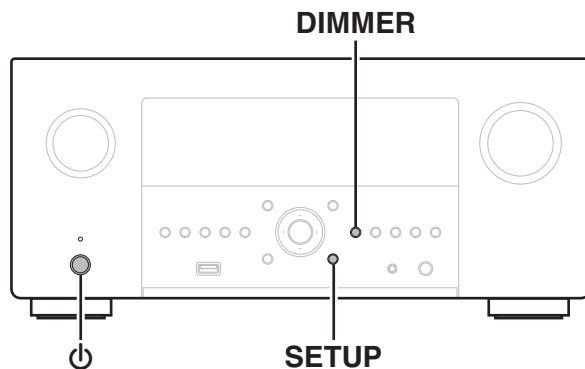

1 Press **⏻** while simultaneously pressing **SETUP** and **DIMMER**.

2 When “Restoring FW...” appears on the display, release the buttons.

When the firmware restore is complete, “Completed” appears on the display for about 5 seconds, and the unit automatically restarts.



- This operation takes time because it requires reconnecting to the network, restoring and updating the firmware.
- If this operation does not improve the problem, contact our customer service center.

NOTE

- Do not turn off the power until the firmware restore is complete.



About HDMI

HDMI is an abbreviation of High-Definition Multimedia Interface, which is an AV digital interface that can be connected to a TV or amplifier.

With the HDMI connection, high definition video and high quality audio formats adopted by Blu-ray Disc players (Dolby Digital Plus, Dolby TrueHD, DTS-HD) can be transmitted, which is not possible with the analog video transmission.

Furthermore, in the HDMI connection, audio and video signals can be transmitted through a single HDMI cable, while in conventional connections it is necessary to provide audio and video cables separately for connection between devices. This allows you to simplify the wiring configuration that tends to be quite complex in a home theater system.

This unit supports the following HDMI functions.

- **Deep Color**

An imaging technology supported by HDMI. Unlike RGB or YCbCr, which uses 8 bits (256 shades) per color, it can use 10 bits (1024 shades), 12 bits (4096 shades), or 16 bits (65536 shades) to produce colors in higher definition.

Both devices linked via HDMI must support Deep Color.

- **x.v.Color**

This function lets HDTVs display colors more accurately. It enables display with natural, vivid colors.

“x.v.Color” is trademark of Sony Corporation.

- **3D**

This unit supports input and output of 3D (3 dimensional) video signals of HDMI. To play back 3D video, you need a TV and player that provide support for the HDMI 3D function and a pair of 3D glasses.

- **4K / 8K**

This unit supports input and output of 4K (3840 x 2160 pixels) and 8K (7680 x 4320 pixels) video signals of HDMI.

- **Content Type**

It automatically makes settings suitable for the video output type (content information).

- **Adobe RGB color, Adobe YCC601 color**

The color space defined by Adobe Systems Inc. Because it is a wider color space than RGB, it can produce more vivid and natural images.

- **sYCC601 color**

Each of these color spaces defines a palette of available colors that is larger than the traditional RGB color model.



- **Auto Lip Sync**

This function can automatically correct delay between the audio and video.

Use a TV that is compatible with the Auto Lip Sync function.

- **HDMI Pass Through**

Even when the power to this unit is set to standby, signals input from the HDMI input connector are output to a TV or other device that is connected to the HDMI output connector.

- **HDMI Control**

If you connect the unit and an HDMI Control function compatible TV or player with an HDMI cable and then enable the HDMI Control function setting on each device, the devices will be able to control each other.

- Power off link

This unit power off can be linked to the TV power off step.

- Audio output destination switching

From the TV, you can switch whether to output audio from the TV or the AV amplifier.

- Volume adjustment

You can adjust this unit's volume in the TV volume adjustment operation.

- Input source switching

You can switch this unit input sources through linkage to TV input switching.

When playing the player, this unit input source switches to the source for that player.

- **ARC (Audio Return Channel)**

This function transmits audio signals from the TV to this unit through the HDMI cable and plays back the audio from the TV on this unit based on the HDMI Control function.

If a TV without the ARC function is connected via HDMI connections, video signals of the playback device connected to this unit are transmitted to the TV, but this unit can not play back the audio from the TV. If you want to enjoy surround audio for TV program, a separate audio cable connection is required.

In contrast, if a TV with the ARC function is connected via HDMI connections, no audio cable connection is required. Audio signals from the TV can be input to this unit through the HDMI cable between this unit and the TV. This function allows you to enjoy surround playback on this unit for the TV.

- **eARC (Enhanced Audio Return Channel)**

The eARC function is an extension of the conventional ARC function. It utilizes dedicated eARC function control to play back television audio from this unit without passing through HDMI control. Furthermore, the eARC function can transmit multichannel linear PCM, Dolby TrueHD, Dolby Atmos, DTS-HD, DTS:X and other audio formats not compatible with conventional ARC. Connecting to an eARC function-compatible television also enables enjoyment of higher-quality surround playback of the audio content played from your television.



- **ALLM (Auto Low Latency Mode)**

This unit automatically switches to low latency mode depending on playback contents when using a combination of television and game console compatible with the ALLM function.

- **VRR (Variable Refresh Rate):**

VRR reduces or eliminates lag, stutter and frame tearing for more fluid and better detailed gameplay.

- **QFT (Quick Frame Transport):**

QFT reduces latency for smoother no-lag gaming, and real-time interactive virtual reality.

NOTE

- Some functions may not operate depending on the connected TV or player. Check the owner's manual of each device for details beforehand.

■ Supported audio formats

2-channel Linear PCM	2-channel, 32 kHz – 192 kHz, 16/20/24 bit
Multi-channel Linear PCM	7.1-channel, 32 kHz – 192 kHz, 16/20/24 bit
Bitstream	Dolby Digital / DTS / Dolby Atmos / Dolby TrueHD / Dolby Digital Plus / DTS:X / DTS-HD / MPEG-H
DSD	2-channel – 5.1-channel, 2.8 MHz

■ Supported video signals

- 480i
- 576i
- 720p 60/50Hz
- 1080p 120/100/60/50/30/25/24Hz
- 8K 60/50/30/25/24Hz
- 480p
- 576p
- 1080i 60/50Hz
- 4K 120/100/60/50/30/25/24Hz



Copyright protection system

In order to play back digital video and audio such as BD video or DVD video via HDMI connection, both this unit and the TV or player must to support the copyright protection system known as HDCP (High-bandwidth Digital Content Protection System). HDCP is copyright protection technology comprised of data encryption and authentication of the connected AV devices. This unit supports HDCP.

- If a device that does not support HDCP is connected, video and audio are not output correctly. Read the owner's manual of your television or player for more information.



Relationship between video signals and monitor output

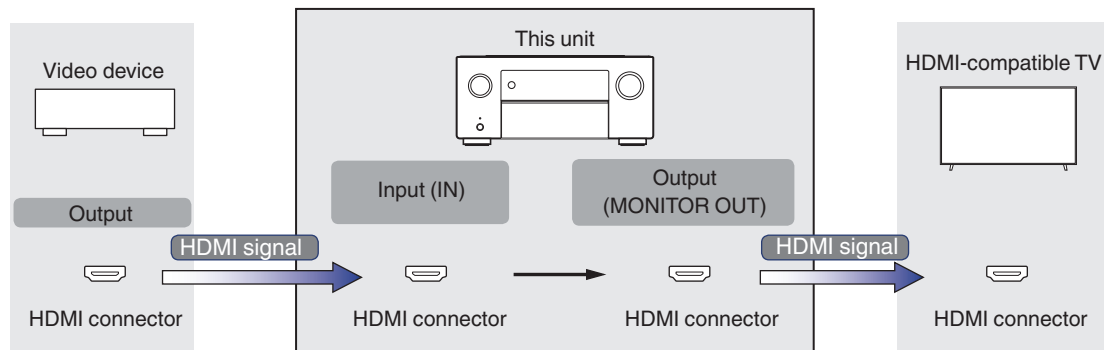

NOTE

- Only HDMI connections are available for the video input/output of this unit.



When “HDMI Upscaler” in the menu is set to “Auto”, this unit upscales the input HDMI video signal and then outputs it to the TV. (👉 p. 192)

Input signal \ Output signal		HDMI												
		480i/576i	480p/576p	720p	1080i	1080p 30/25/24Hz	1080p 60/50Hz	1080p 120/100Hz	4K 30/25/24Hz	4K 60/50Hz	4K 120/100Hz	8K 30/25/24Hz	8K 60/50Hz	
HDMI	480i/576i	✓												
	480p/576p		✓											
	720p			✓										
	1080i				✓									
	1080p 30/25/24Hz					✓		✓				✓		
	1080p 60/50Hz						✓		✓				✓	
	1080p 120/100Hz							✓						
	4K 30/25/24Hz								✓				✓	
	4K 60/50Hz									✓				✓
	4K 120/100Hz										✓			
	8K 30/25/24Hz											✓		
8K 60/50Hz												✓	✓	



Playing back a USB memory devices

- This unit is compatible with MP3 ID3-Tag (Ver. 2) standard.
- This unit can show the artwork that was embedded by using MP3 ID3-Tag Ver. 2.3 or 2.4.
- This unit is compatible with WMA META tags.
- If the image size (pixels) of an album artwork exceeds 500 × 500 (WMA/MP3/Apple Lossless/DSD) or 349 × 349 (MPEG-4 AAC), then music may not be played back properly.

Compatible formats

	Sampling frequency	Channel	Bit rate	Extension
WMA*1	32/44.1/48 kHz	2-channel	48 – 192 kbps	.wma
MP3	32/44.1/48 kHz	2-channel	32 – 320 kbps	.mp3
WAV	32/44.1/48/88.2/ 96/176.4/192 kHz	2-channel	–	.wav
MPEG-4 AAC*1	32/44.1/48 kHz	2-channel	48 - 320 kbps	.aac/.m4a
FLAC	44.1/48/88.2/ 96/176.4/192 kHz	2-channel	–	.flac
Apple Lossless*2	44.1/48/88.2/ 96/176.4/192 kHz	2-channel	–	.m4a
DSD	2.8/5.6 MHz	2-channel	–	.dsf/.dff

*1 Only files that are not protected by copyright can be played on this unit.

Content downloaded from pay sites on the Internet are copyright protected. Also, files encoded in WMA format when ripped from a CD, etc. on a computer may be copyright protected, depending on the computer's settings.

*2 The Apple Lossless Audio Codec (ALAC) decoder is distributed under the Apache License, Version 2.0 (<http://www.apache.org/licenses/LICENSE-2.0>).



■ Maximum number of playable files and folder

The limits on the number of folders and files that can be displayed by this unit are as follows.

Item	Media	USB memory device
Number of folder directory levels *1		8 levels
Number of folders		500
Number of files*2		5000

*1 The limited number includes the root folder.

*2 The allowable number of files may differ according to the USB memory device capacity and the file size.

Playing back a Bluetooth device

This unit supports the following Bluetooth profile.

- A2DP (Advanced Audio Distribution Profile):
When a Bluetooth device that supports this standard is connected, monaural and stereo sound data can be streamed at a high quality.
- AVRCP (Audio/Video Remote Control Profile):
When a Bluetooth device that supports this standard is connected, the Bluetooth device can be operated from this unit.

■ About Bluetooth communications

Radio waves broadcast from this unit may interfere with the operation of medical devices. Make sure you turn off the power of this unit and Bluetooth device in the following locations as radio wave interference may cause malfunctions.

- Hospitals, trains, aircraft, petrol kiosks and places where flammable gases are generated
- Near automatic doors and fire alarms



Playing back a file saved on a PC or NAS

- This unit is compatible with MP3 ID3-Tag (Ver. 2) standard.
- This unit can show the artwork that was embedded by using MP3 ID3-Tag Ver. 2.3 or 2.4.
- This unit is compatible with WMA META tags.
- If the image size (pixels) of an album artwork exceeds 500 × 500 (WMA/MP3/WAV/FLAC/Apple Lossless/DSD) or 349 × 349 (MPEG-4 AAC), then music may not be played back properly.
- A server or server software compatible with distribution in the corresponding formats is required to play music files via a network.
For playing mentioned audio formats via a network a server software, for example Twonky Media Server or jRiver Media Server, needs to be installed on your computer or NAS for full support. There are other server software available too. Please check supported formats.

■ Specifications of supported files

	Sampling frequency	Channel	Bit rate	Extension
WMA*1	32/44.1/48 kHz	2-channel	48 – 192 kbps	.wma
MP3	32/44.1/48 kHz	2-channel	32 – 320 kbps	.mp3
WAV	32/44.1/48/88.2/ 96/176.4/192 kHz	2-channel	–	.wav
MPEG-4 AAC*1	32/44.1/48 kHz	2-channel	48 - 320 kbps	.aac/.m4a
FLAC	44.1/48/88.2/ 96/176.4/192 kHz	2-channel	–	.flac
Apple Lossless*2	44.1/48/88.2/ 96/176.4/192 kHz	2-channel	–	.m4a
DSD	2.8/5.6 MHz	2-channel	–	.dsf/.dff

*1 Only files that are not protected by copyright can be played on this unit.

Content downloaded from pay sites on the Internet are copyright protected. Also, files encoded in WMA format when ripped from a CD, etc. on a computer may be copyright protected, depending on the computer's settings.

*2 The Apple Lossless Audio Codec (ALAC) decoder is distributed under the Apache License, Version 2.0 (<http://www.apache.org/licenses/LICENSE-2.0>).



Playing back Internet Radio

■ Playable broadcast station specifications

	Sampling frequency	Bit rate	Extension
WMA	32/44.1/48 kHz	48 – 192 kbps	.wma
MP3	32/44.1/48 kHz	32 – 320 kbps	.mp3
MPEG-4 AAC	32/44.1/48 kHz	48 - 320 kbps	.aac/ .m4a

Personal memory plus function

The most recently used settings (input mode, HDMI output mode, sound mode, tone control, channel level, MultEQ® XT32, Dynamic EQ, Dynamic Volume, Restorer and audio delay, etc.) are saved for each input source.



- “Surround Parameter” settings are stored for each sound mode.

Last function memory

This function stores the settings which were made before going into the standby mode.



Sound modes and channel output

- This indicates the audio output channels or surround parameters that can be set.
- ⊙ This indicates the audio output channels. The output channels depend on the settings of “Speaker Configuration”. (🔍 p. 225)

Sound mode	Channel output																
	Front L/R	Center	Surround L/R	Surround Back L/R	Front Wide L/R	Front Height L/R	Top Front L/R	Top Middle L/R	Top Rear L/R	Rear Height L/R	Surround Height L/R	Center Height	Top Surround	Front Dolby Atmos Enabled L/R	Surround Dolby Atmos Enabled L/R	Back Dolby Atmos Enabled L/R	Subwoofer
Direct/Pure Direct (2-channel)	○																⊙*4
Direct/Pure Direct (Multi-channel)	○	⊙	⊙	⊙*5	⊙*5	⊙*5	⊙*5	⊙*5	⊙*5	⊙*5	⊙*5	⊙*5	⊙*5	⊙*5	⊙*5	⊙*5	⊙
DSD Direct (2-channel)	○																⊙*4
DSD Direct (Multi-channel)	○	⊙	⊙														⊙
Stereo	○																⊙
Dolby Atmos	○	⊙	⊙	⊙	⊙	⊙	⊙	⊙	⊙	⊙				⊙	⊙	⊙	⊙
Dolby TrueHD	○	⊙	⊙	⊙*5													⊙
Dolby Digital Plus	○	⊙	⊙	⊙*5													⊙
Dolby Digital	○	⊙	⊙														⊙
Dolby Surround *1	○	⊙	⊙	⊙*6	⊙*7	⊙	⊙	⊙	⊙	⊙				⊙	⊙	⊙	⊙
IMAX DTS:X	○	⊙	⊙		⊙	⊙	⊙	⊙	⊙	⊙	⊙		⊙	⊙	⊙	⊙	⊙
IMAX DTS	○	⊙	⊙*8	⊙*8													⊙
DTS:X	○	⊙	⊙	⊙	⊙	⊙	⊙	⊙	⊙	⊙	⊙	⊙	⊙	⊙	⊙	⊙	⊙
DTS-HD	○	⊙	⊙	⊙*5	⊙*5												⊙
DTS Surround	○	⊙	⊙	⊙													⊙
DTS Neural:X *2	○	⊙	⊙	⊙	⊙	⊙	⊙	⊙	⊙	⊙	⊙	⊙	⊙	⊙	⊙	⊙	⊙
DTS Virtual:X *3	○	⊙	⊙	⊙													⊙
Auro-3D	○	⊙	⊙	⊙						⊙*9	⊙	⊙	⊙	⊙*10	⊙*10	⊙*10	⊙
Auro-2D Surround	○	⊙	⊙	⊙													⊙
Multi Ch In	○	⊙	⊙	⊙*5													⊙
MPEG-H	○	⊙	⊙	⊙	⊙	⊙	⊙	⊙	⊙	⊙	⊙	⊙	⊙	⊙	⊙	⊙	⊙

* 1 - * 10: “Sound modes and channel output” (🔍 p. 309)



Sound mode	Channel output																
	Front L/R	Center	Surround L/R	Surround Back L/R	Front Wide L/R	Front Height L/R	Top Front L/R	Top Middle L/R	Top Rear L/R	Rear Height L/R	Surround Height L/R	Center Height	Top Surround	Front Dolby Atmos Enabled L/R	Surround Dolby Atmos Enabled L/R	Back Dolby Atmos Enabled L/R	Subwoofer
Multi Ch Stereo	○	⊙	⊙	⊙	⊙	⊙*11	⊙*11	⊙*11	⊙*11	⊙*11	⊙*11	⊙*11	⊙*11	⊙*11	⊙*11	⊙*11	⊙
Rock Arena	○	⊙	⊙	⊙	⊙	⊙*11	⊙*11	⊙*11	⊙*11	⊙*11	⊙*11	⊙*11	⊙*11	⊙*11	⊙*11	⊙*11	⊙
Jazz Club	○	⊙	⊙	⊙	⊙	⊙*11	⊙*11	⊙*11	⊙*11	⊙*11	⊙*11	⊙*11	⊙*11	⊙*11	⊙*11	⊙*11	⊙
Mono Movie	○	⊙	⊙	⊙	⊙	⊙*11	⊙*11	⊙*11	⊙*11	⊙*11	⊙*11	⊙*11	⊙*11	⊙*11	⊙*11	⊙*11	⊙
Video Game	○	⊙	⊙	⊙	⊙	⊙*11	⊙*11	⊙*11	⊙*11	⊙*11	⊙*11	⊙*11	⊙*11	⊙*11	⊙*11	⊙*11	⊙
Matrix	○	⊙	⊙	⊙	⊙	⊙*11	⊙*11	⊙*11	⊙*11	⊙*11	⊙*11	⊙*11	⊙*11	⊙*11	⊙*11	⊙*11	⊙
Virtual	○																⊙

- *1 The applicable sound mode includes “Dolby Surround” and sound modes that have “+Dolby Surround” in the sound mode name.
- *2 The applicable sound mode includes “DTS Neural:X” and sound modes that have “+Neural:X” in the sound mode name.
- *3 The applicable sound mode includes “DTS Virtual:X” and sound modes that have “+Virtual:X” in the sound mode name.
- *4 Audio is output when “Bass” - “Subwoofer Output” in the menu is set to “LFE + Main”. (☞ p. 236)
- *5 A signal for each channel contained in an input signal is output as audio.
- *6 Audio is not output when the “Surround Parameter” - “Speaker Virtualizer” in the menu is set to “On” and “Speaker Configuration” - “Surround Back” in the menu is set to “1 spkr”. (☞ p. 173, 229)
- *7 Audio is not output when the “Surround Parameter” - “Speaker Virtualizer” is set to “On”. (☞ p. 173)
- *8 When “Speaker Configuration” - “Surround Back” is set to “2 spkrs”, “Speaker Configuration” - “Center” is set to “Large” or “Small”, and sound mode is set to “IMAX DTS”, surround audio is output from the surround back speaker. Audio is not output from the surround speaker. (☞ p. 229)
- *9 For the best Auro-3D experience Surround Height speakers are recommended, however you may substitute Rear Height speakers from a Dolby Atmos speaker setup in place of Surround Height speakers.
- *10 For the best Auro-3D experience Front Height and Surround Height speakers are recommended, however you may substitute Dolby Atmos Enabled speakers.
- *11 Audio is output from the speakers specified in the “Surround Parameter” - “Speaker Select” settings. (☞ p. 178)



Sound modes and surround parameters

Sound mode	Surround Parameter														
	Cinema EQ	Loudness Management *2	Dynamic Compression *3	Dialog Control *4	Low Frequency Effects *5	Delay Time	Effect Level	Room Size	Speaker Select *6	Center Spread	Speaker Virtualizer *7	DTS Neural:X	IMAX	IMAX Audio Settings	High Pass Filter *8
Direct/Pure Direct (2-channel) *1		<input type="radio"/>	<input type="radio"/>												
Direct/Pure Direct (Multi-channel) *1		<input type="radio"/>	<input type="radio"/>	<input type="radio"/>	<input type="radio"/>										
DSD Direct (2-channel)															
DSD Direct (Multi-channel)															
Stereo		<input type="radio"/>	<input type="radio"/>	<input type="radio"/>	<input type="radio"/>										
Dolby Atmos	<input type="radio"/>	<input type="radio"/>	<input type="radio"/>	<input type="radio"/>	<input type="radio"/>						<input type="radio"/>				
Dolby TrueHD	<input type="radio"/>	<input type="radio"/>	<input type="radio"/>	<input type="radio"/>	<input type="radio"/>										
Dolby Digital Plus	<input type="radio"/>	<input type="radio"/>	<input type="radio"/>	<input type="radio"/>	<input type="radio"/>										
Dolby Digital	<input type="radio"/>	<input type="radio"/>	<input type="radio"/>	<input type="radio"/>	<input type="radio"/>										
Dolby Surround	<input type="radio"/>	<input type="radio"/>	<input type="radio"/>	<input type="radio"/>	<input type="radio"/>					<input type="radio"/>	<input type="radio"/>				
IMAX DTS:X	<input type="radio"/>		<input type="radio"/>	<input type="radio"/>	<input type="radio"/>							<input type="radio"/>	<input type="radio"/>	<input type="radio"/>	<input type="radio"/>
IMAX DTS	<input type="radio"/>		<input type="radio"/>	<input type="radio"/>	<input type="radio"/>							<input type="radio"/>	<input type="radio"/>	<input type="radio"/>	<input type="radio"/>
DTS:X	<input type="radio"/>		<input type="radio"/>	<input type="radio"/>	<input type="radio"/>							<input type="radio"/>	<input type="radio"/>	<input type="radio"/>	<input type="radio"/>
DTS-HD	<input type="radio"/>		<input type="radio"/>	<input type="radio"/>	<input type="radio"/>								<input type="radio"/>	<input type="radio"/>	<input type="radio"/>
DTS Surround	<input type="radio"/>		<input type="radio"/>	<input type="radio"/>	<input type="radio"/>								<input type="radio"/>	<input type="radio"/>	<input type="radio"/>
DTS Neural:X	<input type="radio"/>	<input type="radio"/>	<input type="radio"/>	<input type="radio"/>	<input type="radio"/>										
DTS Virtual:X	<input type="radio"/>		<input type="radio"/>	<input type="radio"/>	<input type="radio"/>										
Auro-3D	<input type="radio"/>				<input type="radio"/>										
Auro-2D Surround	<input type="radio"/>				<input type="radio"/>										
Multi Ch In	<input type="radio"/>				<input type="radio"/>										
MPEG-H	<input type="radio"/>				<input type="radio"/>										
Multi Ch Stereo	<input type="radio"/>	<input type="radio"/>	<input type="radio"/>	<input type="radio"/>	<input type="radio"/>						<input type="radio"/>				
Rock Arena		<input type="radio"/>	<input type="radio"/>	<input type="radio"/>	<input type="radio"/>		<input type="radio"/>	<input type="radio"/>	<input type="radio"/>		<input type="radio"/>				
Jazz Club		<input type="radio"/>	<input type="radio"/>	<input type="radio"/>	<input type="radio"/>		<input type="radio"/>	<input type="radio"/>	<input type="radio"/>		<input type="radio"/>				
Mono Movie		<input type="radio"/>	<input type="radio"/>	<input type="radio"/>	<input type="radio"/>		<input type="radio"/>	<input type="radio"/>	<input type="radio"/>		<input type="radio"/>				
Video Game		<input type="radio"/>	<input type="radio"/>	<input type="radio"/>	<input type="radio"/>		<input type="radio"/>	<input type="radio"/>	<input type="radio"/>		<input type="radio"/>				
Matrix		<input type="radio"/>	<input type="radio"/>	<input type="radio"/>	<input type="radio"/>	<input type="radio"/>			<input type="radio"/>						
Virtual		<input type="radio"/>	<input type="radio"/>	<input type="radio"/>	<input type="radio"/>	<input type="radio"/>									

* 1 - * 8 : "Sound modes and surround parameters" (📖 p. 312)



Sound mode	Surround Parameter						Dialog Enhancer	Tone *9	Subwoofer Level Adjust *10	Audyssey				Restorer *15	Bass Sync *5
	Low Pass Filter *8	Subwoofer Output *8	Auro-Matic 3D Preset	Auro-Matic 3D Strength	Auro-3D Mode	Subwoofer				MultiEQ® XT32 *11*12	Dynamic EQ *13*14	Dynamic Volume *13*14	Audyssey LFC™ *13*14		
Direct/Pure Direct (2-channel) *1						<input type="radio"/> *16			<input type="radio"/> *16						
Direct/Pure Direct (Multi-channel) *1															<input type="radio"/>
DSD Direct (2-channel)						<input type="radio"/> *16			<input type="radio"/> *16						
DSD Direct (Multi-channel)									<input type="radio"/>						<input type="radio"/>
Stereo						<input type="radio"/> *17	<input type="radio"/>	<input type="radio"/>	<input type="radio"/> *17	<input type="radio"/>	<input type="radio"/>	<input type="radio"/>	<input type="radio"/>	<input type="radio"/>	<input type="radio"/>
Dolby Atmos							<input type="radio"/>	<input type="radio"/>	<input type="radio"/>	<input type="radio"/>	<input type="radio"/>	<input type="radio"/>	<input type="radio"/>	<input type="radio"/>	<input type="radio"/>
Dolby TrueHD							<input type="radio"/>	<input type="radio"/>	<input type="radio"/>	<input type="radio"/>	<input type="radio"/>	<input type="radio"/>	<input type="radio"/>	<input type="radio"/>	<input type="radio"/>
Dolby Digital Plus							<input type="radio"/>	<input type="radio"/>	<input type="radio"/>	<input type="radio"/>	<input type="radio"/>	<input type="radio"/>	<input type="radio"/>	<input type="radio"/>	<input type="radio"/>
Dolby Digital							<input type="radio"/>	<input type="radio"/>	<input type="radio"/>	<input type="radio"/>	<input type="radio"/>	<input type="radio"/>	<input type="radio"/>	<input type="radio"/>	<input type="radio"/>
Dolby Surround							<input type="radio"/>	<input type="radio"/>	<input type="radio"/>	<input type="radio"/>	<input type="radio"/>	<input type="radio"/>	<input type="radio"/>	<input type="radio"/>	<input type="radio"/>
IMAX DTS:X	<input type="radio"/>	<input type="radio"/>					<input type="radio"/>	<input type="radio"/>	<input type="radio"/>	<input type="radio"/>	<input type="radio"/>	<input type="radio"/>	<input type="radio"/>	<input type="radio"/>	<input type="radio"/>
IMAX DTS	<input type="radio"/>	<input type="radio"/>					<input type="radio"/>	<input type="radio"/>	<input type="radio"/>	<input type="radio"/>	<input type="radio"/>	<input type="radio"/>	<input type="radio"/>	<input type="radio"/>	<input type="radio"/>
DTS:X							<input type="radio"/>	<input type="radio"/>	<input type="radio"/>	<input type="radio"/>	<input type="radio"/>	<input type="radio"/>	<input type="radio"/>	<input type="radio"/>	<input type="radio"/>
DTS-HD							<input type="radio"/>	<input type="radio"/>	<input type="radio"/>	<input type="radio"/>	<input type="radio"/>	<input type="radio"/>	<input type="radio"/>	<input type="radio"/>	<input type="radio"/>
DTS Surround							<input type="radio"/>	<input type="radio"/>	<input type="radio"/>	<input type="radio"/>	<input type="radio"/>	<input type="radio"/>	<input type="radio"/>	<input type="radio"/>	<input type="radio"/>
DTS Neural:X							<input type="radio"/>	<input type="radio"/>	<input type="radio"/>	<input type="radio"/>	<input type="radio"/>	<input type="radio"/>	<input type="radio"/>	<input type="radio"/>	<input type="radio"/>
DTS Virtual:X							<input type="radio"/>	<input type="radio"/>	<input type="radio"/>	<input type="radio"/>	<input type="radio"/>	<input type="radio"/>	<input type="radio"/>	<input type="radio"/>	<input type="radio"/>
Auro-3D			<input type="radio"/> *18	<input type="radio"/> *18	<input type="radio"/> *19		<input type="radio"/>	<input type="radio"/>	<input type="radio"/>	<input type="radio"/>	<input type="radio"/>	<input type="radio"/>	<input type="radio"/>	<input type="radio"/>	<input type="radio"/>
Auro-2D Surround							<input type="radio"/>	<input type="radio"/>	<input type="radio"/>	<input type="radio"/>	<input type="radio"/>	<input type="radio"/>	<input type="radio"/>	<input type="radio"/>	<input type="radio"/>
Multi Ch In							<input type="radio"/>	<input type="radio"/>	<input type="radio"/>	<input type="radio"/>	<input type="radio"/>	<input type="radio"/>	<input type="radio"/>	<input type="radio"/>	<input type="radio"/>
MPEG-H							<input type="radio"/>	<input type="radio"/>	<input type="radio"/>	<input type="radio"/>	<input type="radio"/>	<input type="radio"/>	<input type="radio"/>	<input type="radio"/>	<input type="radio"/>
Multi Ch Stereo							<input type="radio"/>	<input type="radio"/>	<input type="radio"/>	<input type="radio"/>	<input type="radio"/>	<input type="radio"/>	<input type="radio"/>	<input type="radio"/>	<input type="radio"/>
Rock Arena							<input type="radio"/>	<input type="radio"/>	<input type="radio"/>	<input type="radio"/>	<input type="radio"/>	<input type="radio"/>	<input type="radio"/>	<input type="radio"/>	<input type="radio"/>
Jazz Club							<input type="radio"/>	<input type="radio"/>	<input type="radio"/>	<input type="radio"/>	<input type="radio"/>	<input type="radio"/>	<input type="radio"/>	<input type="radio"/>	<input type="radio"/>
Mono Movie							<input type="radio"/>	<input type="radio"/>	<input type="radio"/>	<input type="radio"/>	<input type="radio"/>	<input type="radio"/>	<input type="radio"/>	<input type="radio"/>	<input type="radio"/>
Video Game							<input type="radio"/>	<input type="radio"/>	<input type="radio"/>	<input type="radio"/>	<input type="radio"/>	<input type="radio"/>	<input type="radio"/>	<input type="radio"/>	<input type="radio"/>
Matrix							<input type="radio"/>	<input type="radio"/>	<input type="radio"/>	<input type="radio"/>	<input type="radio"/>	<input type="radio"/>	<input type="radio"/>	<input type="radio"/>	<input type="radio"/>
Virtual							<input type="radio"/>	<input type="radio"/>	<input type="radio"/>	<input type="radio"/>	<input type="radio"/>	<input type="radio"/>	<input type="radio"/>	<input type="radio"/>	<input type="radio"/>

*1, *5, *8 - *19: "Sound modes and surround parameters" (🔍 p. 312)



- *1 During playback in Pure Direct mode, the surround parameters are the same as in Direct mode.
- *2 This item can be selected when a Dolby Digital, Dolby Digital Plus, Dolby TrueHD or Dolby Atmos signal is played.
- *3 This item can be selected when a Dolby Digital, Dolby Digital Plus, Dolby TrueHD, Dolby Atmos, DTS:X, DTS-HD or DTS signal is played.
- *4 This item can be selected when a DTS:X signal that is compatible with the Dialog Control function is input.
- *5 This can be set when the LFE signal is included in the input signal.
- *6 This item can be selected when Height, Ceiling or Dolby Atmos Enabled speakers are used.
- *7 This item can be set when any Height, Ceiling or Dolby Atmos Enabled speakers are not used, or Surround speakers are not used.
- *8 This item can be selected when "Surround Parameter" - "IMAX Audio Settings" in the menu is set to "Manual". (🔍 p. 174)
- *9 This item cannot be set when "Dynamic EQ" is set to "On". (🔍 p. 182)
- *10 This item cannot be set when "Speaker Configuration" - "Subwoofer" in the menu is set to "None". (🔍 p. 225)
- *11 This item cannot be set when Audyssey® Setup (Speaker Calibration) has not been performed.
- *12 This item cannot be selected when a DTS:X format with a sampling frequency of over 48 kHz is input.
- *13 This item cannot be set when sound mode is "DTS Virtual:X" or sound mode that have "+Virtual:X" in the sound mode name.
- *14 This item cannot be set when "MultEQ® XT32" in the menu is set to "Off". (🔍 p. 181)
- *15 This item can be set when the input signal is analog, PCM 48 kHz or 44.1 kHz.
- *16 This setting is available when "Bass" - "Subwoofer Output" in the menu is set to "LFE + Main". (🔍 p. 236)
- *17 This item can be set when "Speaker Configuration" - "Front" is set to "Small" or "Bass" - "Subwoofer Output" is set to "LFE + Main". (🔍 p. 225, 236)
- *18 This cannot be set if the input signal contains Auro-3D signals containing a Height channel.
- *19 This can be set if the input signal contains an Auro-3D signal.



Types of input signals, and corresponding sound modes

- This indicates the default sound mode.
- This indicates the selectable sound mode.

Sound mode	NOTE	2-channel signal							Multi-channel signal													
		Dolby TrueHD	Dolby Digital Plus	Dolby Digital	DTS-HD	DTS	Analog / PCM	DSD (Super Audio CD)	Dolby Atmos	Dolby TrueHD	Dolby Digital Plus	Dolby Digital (EX)	IMAX DTS:X	IMAX DTS	DTS:X	DTS-HD	DTS	Auro-3D	PCM multi-channel	MPEG-H	DSD (Super Audio CD)	
Direct																						
Direct		○	○	○	○	○	○*2		○	○	○	○	○	○	○	○	○	○	○	○	○	○
DSD Direct							○															○
Pure Direct																						
Pure Direct		○	○	○	○	○	○		○	○	○	○	○	○	○	○	○	○	○	○	○	○
DSD Pure Direct							○															○
Stereo																						
Stereo		○	○	○	○	○	●	●	○	○	○	○	○	○	○	○	○	○	○	○	○	○
Dolby Surround																						
Dolby Atmos	*1								●													
Dolby TrueHD		○							○*3	○								○*4				
Dolby Digital Plus			○						○*5		○											
Dolby Digital				○							○											
Dolby (D+) (HD) + Dolby Surround										●	●	●						○*4				
Dolby (D+) (HD) + Neural:X									○	○	○							○*4				
Dolby Surround		●	●	●	○	○	○	○														

* 1 - *5: "Types of input signals, and corresponding sound modes" (🔍 p. 316)



Sound mode	NOTE	2-channel signal							Multi-channel signal														
		Dolby TrueHD	Dolby Digital Plus	Dolby Digital	DTS-HD	DTS	Analog / PCM	DSD (Super Audio CD)	Dolby Atmos	Dolby TrueHD	Dolby Digital Plus	Dolby Digital (EX)	IMAX DTS:X	IMAX DTS	DTS:X	DTS-HD	DTS	Auro-3D	PCM multi-channel	MPEG-H	DSD (Super Audio CD)		
DTS Surround																							
IMAX DTS:X												●*6											
IMAX DTS													○*6										
DTS:X												○*7		●									
DTS-HD					○								○*7		○				○*8				
DTS Surround						○							○*7										
IMAX DTS + Neural:X												●*6											
IMAX DTS / IMAX DTS:X + Virtual:X												○*6	○*6										
DTS (-HD) + Dolby Surround												○							○*8				
DTS (-HD) + Neural:X												○*7		●*9	●*9				○*8	○*8			
DTS (-HD) / DTS:X + Virtual:X												○*7	○*7	○*10					○*8	○*8			
DTS Neural:X		○	○	○	●*10	●*10	○	○															
DTS Virtual:X					○	○	○	○															
Auro-3D																							
Auro-3D	*11	○	○	○	○	○	○	○		○	○	○		○		○	○	○	○	○		○	○
Auro-2D Surround	*11	○	○	○	○	○	○	○		○	○	○		○		○	○	○	○	○		○	○
Multi Ch In																							
Multi Ch In / Multi Ch In 7.1																			○*12	●*13		●	●
Multi In + Dolby Surround																				○		○	○
Multi In + Neural:X																				○		○	○
Multi In + Virtual:X																				○		○	○

*6 - *13 : "Types of input signals, and corresponding sound modes" (📖 p. 316)



Sound mode	NOTE	2-channel signal							Multi-channel signal														
		Dolby TrueHD	Dolby Digital Plus	Dolby Digital	DTS-HD	DTS	Analog / PCM	DSD (Super Audio CD)	Dolby Atmos	Dolby TrueHD	Dolby Digital Plus	Dolby Digital (EX)	IMAX DTS:X	IMAX DTS	DTS:X	DTS-HD	DTS	Auro-3D	PCM multi-channel	MPEG-H	DSD (Super Audio CD)		
MPEG-H																							
MPEG-H																					●		
Original sound mode																							
Multi Ch Stereo		○	○	○	○	○	○	○	○	○	○	○	○	○	○	○	○	○	○	○	○	○	○
Rock Arena		○	○	○	○	○	○	○	○	○*14	○	○	○	○	○	○	○	○	○	○	○	○	○
Jazz Club		○	○	○	○	○	○	○	○	○*14	○	○	○	○	○	○	○	○	○	○	○	○	○
Mono Movie		○	○	○	○	○	○	○	○	○*14	○	○	○	○	○	○	○	○	○	○	○	○	○
Video Game		○	○	○	○	○	○	○	○	○*14	○	○	○	○	○	○	○	○	○	○	○	○	○
Matrix		○	○	○	○	○	○	○	○	○*14	○	○	○	○	○	○	○	○	○	○	○	○	○
Virtual		○	○	○	○	○	○	○	○	○*14	○	○	○	○	○	○	○	○	○	○	○	○	○

*14 : "Types of input signals, and corresponding sound modes" (🔍 p. 316)



- *1 This item can be selected when using any of the Surround Back, Front Height, Top Front, Top Middle, Top Rear, Rear Height, Front Dolby, Surround Dolby or Back Dolby speaker. It can also be selected when the "Surround Parameter" - "Speaker Virtualizer" setting is turned "On".
- *2 The default sound mode for the AirPlay playback is "Direct".
- *3 This can be selected when the Dolby Atmos signal contains the Dolby TrueHD signal.
- *4 This item can be selected if the Auro-3D signal contains Dolby TrueHD.
- *5 This can be selected when the Dolby Atmos signal contains the Dolby Digital Plus signal.
- *6 Selectable when "Surround Parameter" - "IMAX" is set to "Auto" in the menu. (🔍 p. 174)
- *7 Selectable when "Surround Parameter" - "IMAX" is set to "Off". (Selectable sound modes vary depending on the type of input signal). (🔍 p. 174)
- *8 This item can be selected if the Auro-3D signal contains DTS-HD.
- *9 This item cannot be selected when a DTS(-HD) format with a sampling frequency of over 48 kHz is input.
- *10 This item cannot be selected when a DTS:X format with a sampling frequency of over 48 kHz is input.
- *11 This item cannot be selected if the sampling frequency of the input signal is 32 kHz.
- *12 This item can be selected if the Auro-3D signal contains Multi Channel PCM.
- *13 Multi ch In 7.1 can be selected only when the input signals include surround back signals and surround back speakers are being used.
- *14 This can be selected when the Dolby Atmos signal contains the Dolby TrueHD or Dolby Digital Plus signal.



Explanation of terms

■ Audyssey

Audyssey Dynamic EQ®

Audyssey Dynamic EQ® solves the problem of deteriorating sound quality as volume is decreased by taking into account human perception and room acoustics.

Audyssey Dynamic EQ® works in tandem with Audyssey MultEQ® XT32 to provide well-balanced sound for every listener at any volume level.

Audyssey Dynamic Volume®

Dynamic Volume solves the problem of large variations in volume level between television programs, commercials, and between the soft and loud passages of movies. Audyssey Dynamic EQ® is integrated into Dynamic Volume so that as the playback volume is adjusted automatically, the perceived bass response, tonal balance, surround impression, and dialog clarity remain the same.

Audyssey LFC™ (Low Frequency Containment)

Audyssey LFC™ solves the problem of low frequency sounds disturbing people in neighboring rooms or apartments. Audyssey LFC™ dynamically monitors the audio content and removes the low frequencies that pass through walls, floors and ceilings. It then applies psychoacoustic processing to restore the perception of low bass for listeners in the room. The result is great sound that no longer disturbs the neighbors.

Audyssey MultEQ® XT32

Audyssey MultEQ® XT32 is a room equalization solution that calibrates any audio system so that it can achieve optimum performance for every listener in a large listening area. Based on several room measurements, MultEQ® XT32 calculates an equalization solution that corrects for both time and frequency response problems in the listening area and also performs a fully automated surround system setup.



■ Auro-3D

Auro-3D®

The Auro-3D® technology suite is a groundbreaking new audio technology that combines height-based listening formats with powerful creative tools to deliver an unrivaled three-dimensional sound experience. Auro-3D® is the general format name for Sound in 3D and its related speaker lay-outs.

Auro-Matic®

Auro-Matic® up-mixing technology software is a unique creative tool that transforms legacy Mono, Stereo and Surround content into a natural 3D or 2D listening experience.

■ Dolby

Dolby Atmos

Introduced first in the cinema, Dolby Atmos brings a revolutionary sense of dimension and immersion to the Home Theater experience. Dolby Atmos is an adaptable and scalable object based format that reproduces audio as independent sounds (or objects) that can be accurately positioned and move dynamically throughout the 3 dimensional listening space during playback. A key ingredient of Dolby Atmos is the introduction of a height plane of sound above the listener.

Dolby Atmos Stream

Dolby Atmos content will be delivered to your Dolby Atmos Enabled AV receiver via Dolby Digital Plus or Dolby TrueHD on Blu-ray Disc, downloadable files and streaming media. A Dolby Atmos stream contains special metadata that describes the positioning of sounds within the room. This object audio data is decoded by a Dolby Atmos AV receiver and scaled for optimum playback through Home Theater speaker systems of every size and configuration.



Dolby Digital

Dolby Digital is a multi-channel digital signal format developed by Dolby Laboratories.

A total of 5.1-channels are played: 3 front channels (“FL”, “FR” and “C”), 2 surround channels (“SL” and “SR”) and the “LFE” channel for low frequency effects.

Because of this, there is no crosstalk between channels and a realistic sound field with a “three-dimensional” feeling (sense of distance, movement and positioning) is achieved. This delivers a thrilling surround sound experience in the home.

Dolby Digital Plus

Dolby Digital Plus is an improved Dolby Digital signal format that is compatible with up to 7.1-channels of discrete digital sound and also improves sound quality thanks to extra data bit rate performance. It is upwardly compatible with conventional Dolby Digital, so it offers greater flexibility in response to the source signal and the conditions of the playback device.

Dolby Surround

Dolby Surround is a next generation surround technology that intelligently up mixes stereo; 5.1 and 7.1 content for playback through your surround speaker system. Dolby Surround is compatible with traditional speaker layouts, as well as Dolby Atmos enabled playback systems that employ in-ceiling speakers or products with Dolby speaker technology.

Dolby Speaker Technology (Dolby Atmos Enabled speakers)

A convenient alternative to speakers built into the ceiling, Dolby Atmos Enabled speakers employ the ceiling above you as a reflective surface for reproducing audio in the height plane above the listener. These speakers feature a unique upward firing driver and special signal processing. These features can be built into a conventional speaker or standalone speaker module. The features minimally impact the overall speaker footprint while providing an immersive listening experience during Dolby Atmos and Dolby Surround playback.

Dolby TrueHD

Dolby TrueHD is a high definition audio technology developed by Dolby Laboratories, using lossless coding technology to faithfully reproduce the sound of the studio master.

This format provides the facility to support up to 8 audio channels with a sampling frequency of 96 kHz/24 bit resolution and up to 6 audio channels with a sampling frequency of 192 kHz/24 bit resolution.



Speaker Virtualizer

Dolby Atmos height virtualization is a digital signal processing solution that leverages Dolby's deep understanding of human audio perception to create the sensation of overhead sound from the listener-level speakers. This signal processing applies height-cue filters to overhead audio components contained within the audio signal before they are mixed into the listener-level speakers.

These filters simulate the natural spectral cues imparted by our ears to sounds that originate from overhead.

For stereo and 3.1-channel speaker configuration, Dolby Atmos height virtualization is combined with surround virtualization to create an enveloping 360-degree audio minus the speakers that would ordinarily be employed behind or to the side of the listener.

■ DTS

Dialog Control

Gives you control of the listening experience. You can lift the dialog out from the background sounds when clarity and intelligibility are desired. This requires that content has been authored to support Dialog Control.

DTS

This is an abbreviation of Digital Theater System, which is a digital audio system developed by DTS. DTS delivers a powerful and dynamic surround sound experience, and is found in the world's finest movie theaters and screening rooms.

DTS 96/24

DTS 96/24 is a digital audio format enabling high sound quality playback in 5.1-channels with a sampling frequency of 96 kHz and 24 bit quantization on DVD-Video.

DTS Digital Surround

DTS™ Digital Surround is the standard digital surround format of DTS, Inc., compatible with a sampling frequency of 44.1 or 48 kHz and up to 5.1-channels of digital discrete surround sound.



DTS-ES™ Discrete 6.1

DTS-ES™ Discrete 6.1 is a 6.1-channel discrete digital audio format adding a surround back (SB) channel to the DTS digital surround sound. Decoding of conventional 5.1-channel audio signals is also possible according to the decoder.

DTS-ES™ Matrix 6.1

DTS-ES™ Matrix 6.1 is a 6.1-channel audio format that inserts a surround back (SB) channel to the DTS digital surround sound through matrix encoding. Decoding of conventional 5.1-channel audio signals is also possible according to the decoder.

DTS Express

DTS Express is an audio format supporting low bit rates (max. 5.1-channels, 24 to 256 kbps).

DTS-HD

This audio technology provides higher sound quality and enhanced functionality than the conventional DTS and is adopted as an optional audio for Blu-ray Disc.

This technology supports multi-channel, high data transfer speed, high sampling frequency, and lossless audio playback. Maximum 7.1-channels are supported in Blu-ray Disc.

DTS-HD High Resolution Audio

DTS-HD High Resolution Audio is an improved version of the conventional DTS, DTS-ES and DTS 96/24 signals formats, compatible with sampling frequencies of 96 or 48 kHz and up to 7.1-channels of discrete digital sound. High data bit rate performance provides high quality sound. This format is fully compatible with conventional products, including conventional DTS digital surround 5.1-channel data.

DTS-HD Master Audio

DTS-HD Master Audio is a lossless audio format created by Digital Theater System (DTS). This format provides the facility to support up to 8 audio channels with a sampling frequency of 96 kHz/24 bit resolution and up to 6 audio channels with a sampling frequency of 192 kHz/24 bit resolution. It is fully compatible with conventional products, including conventional DTS digital surround 5.1-channel data.

DTS:X

DTS:X produces a hemisphere of audio, where flyovers as well as ambient backgrounds become truly enveloping. DTS:X objects enable audio to move smoothly from one speaker to any other creating life-like realism.



DTS Neural:X

Enables an immersive audio experience for older content. DTS Neural:X can upmix your stereo, 5.1 or 7.1 content to take full advantage of all speakers in your surround sound system.

DTS Virtual:X

DTS Virtual:X allows you to enjoy multi-dimensional sound regardless of room size, layout, or speaker configuration.

IMAX®

IMAX® is well admired around the world for a premium large format movie experience. IMAX delivers the most advanced movie projection technology combined with rich, deep sound.

■ Audio**Apple Lossless Audio Codec**

This is a codec for lossless audio compression method developed by Apple Inc. This codec can be played back on iTunes, iPod or iPhone. Data compressed to approximately 60 – 70 % can be decompressed to exactly the same original data.

Bass Sync

Audio sources such as BD and DVD inherently have time delay between the bass components of the satellite channel and the LFE channel. This function adjusts such a delay for reproducing (replaying) richer bass sound during playback. This function is by default set to 0 msec. Since the delay varies according to the title, play back the audio source and adjust to the most effective value for playback. For some audio sources that are played back, this function may have little effect.



FLAC (Free Lossless Audio Codec)

FLAC stands for Free lossless Audio Codec, and is a lossless free audio file format. Lossless means that the audio is compressed without any loss in quality.

The FLAC license is as shown below.

Copyright (C) 2000, 2001, 2002, 2003, 2004, 2005, 2006, 2007, 2008, 2009 Josh Coalson

Redistribution and use in source and binary forms, with or without modification, are permitted provided that the following conditions are met:

- Redistributions of source code must retain the above copyright notice, this list of conditions and the following disclaimer.
- Redistributions in binary form must reproduce the above copyright notice, this list of conditions and the following disclaimer in the documentation and/or other materials provided with the distribution.
- Neither the name of the Xiph.org Foundation nor the names of its contributors may be used to endorse or promote products derived from this software without specific prior written permission.

THIS SOFTWARE IS PROVIDED BY THE COPYRIGHT HOLDERS AND CONTRIBUTORS "AS IS" AND ANY EXPRESS OR IMPLIED WARRANTIES, INCLUDING, BUT NOT LIMITED TO, THE IMPLIED WARRANTIES OF MERCHANTABILITY AND FITNESS FOR A PARTICULAR PURPOSE ARE DISCLAIMED. IN NO EVENT SHALL THE FOUNDATION OR CONTRIBUTORS BE LIABLE FOR ANY DIRECT, INDIRECT, INCIDENTAL, SPECIAL, EXEMPLARY, OR CONSEQUENTIAL DAMAGES (INCLUDING, BUT NOT LIMITED TO, PROCUREMENT OF SUBSTITUTE GOODS OR SERVICES; LOSS OF USE, DATA, OR PROFITS; OR BUSINESS INTERRUPTION) HOWEVER CAUSED AND ON ANY THEORY OF LIABILITY, WHETHER IN CONTRACT, STRICT LIABILITY, OR TORT (INCLUDING NEGLIGENCE OR OTHERWISE) ARISING IN ANY WAY OUT OF THE USE OF THIS SOFTWARE, EVEN IF ADVISED OF THE POSSIBILITY OF SUCH DAMAGE.

LFE

This is an abbreviation of Low Frequency Effect, which is an output channel that emphasizes low frequency effect sound. Surround audio is intensified by outputting 20 Hz to 120 Hz deep bass to the system subwoofer(s).

MP3 (MPEG Audio Layer-3)

This is an internationally standardized audio data compression scheme, using the "MPEG-1" video compression standard. It compresses the data volume to about one eleventh its original size while maintaining sound quality equivalent to a music CD.



MPEG (Moving Picture Experts Group), MPEG-2, MPEG-4

These are the names for digital compression format standards used for the encoding of video and audio. Video standards include “MPEG-1 Video”, “MPEG-2 Video”, “MPEG-4 Visual”, “MPEG-4 AVC”. Audio standards include “MPEG-1 Audio”, “MPEG-2 Audio”, “MPEG-4 AAC”.

MPEG-H

MPEG-H 3D Audio is a new audio technology to truly immerse and envelop listeners in sound from all directions, which opens an entire new level of sound going beyond stereo and surround. With sound coming from above, a third dimension is added to the audio experience making it much more realistic and natural.

Thanks to its unique personalization features, MPEG-H 3D Audio also offers users a great flexibility to actively engage with the content and adapt it to their own preferences.

MPEG-H 3D Audio enables true object based sound and is also the basis of Sony’s 360 Reality Audio for immersive music streaming services. 360 Reality Audio makes it possible for artists and creators to produce music by mapping sound sources such as vocals, chorus and instruments with positional information and placing them within a spherical space.

WMA (Windows Media Audio)

This is audio compression technology developed by Microsoft Corporation.

WMA data can be encoded using Windows Media® Player.

To encode WMA files, only use applications authorized by Microsoft Corporation. If you use an unauthorized application, the file may not work properly.

Sampling frequency

Sampling involves taking a reading of a sound wave (analog signal) at regular intervals and expressing the height of the wave at each reading in digitized format (producing a digital signal).

The number of readings taken in one second is called the “sampling frequency”. The larger the value, the closer the reproduced sound is to the original.



Speaker impedance

This is an AC resistance value, indicated in Ω (ohms).

Greater power can be obtained when this value is smaller.

Dialogue normalization function

This function operates automatically during playback of Dolby Digital, Dolby Digital Plus, Dolby TrueHD, Dolby Atmos, DTS or DTS-HD sources. It automatically corrects the standard signal level for individual program sources.

Dynamic range

The difference between the maximum undistorted sound level and the minimum discernible level above the noise emitted by the device.

Downmix

This function converts the number of channels of surround audio to a lower number of channels and plays back according to the system's configuration.

■ Video**Progressive (sequential scanning)**

This is a scanning system of the video signal that displays 1 frame of video as one image. Compared to the interlace system, this system provides images with less flickering and jagged edges.



■ Network

AirPlay

AirPlay sends (plays) contents recorded in iTunes or on an iPhone/iPod touch/iPad to a compatible device via the network.

WEP Key (network key)

This is key information used for encrypting data when conducting data transfer. On this unit, the same WEP key is used for data encryption and decryption, so the same WEP key must be set on both devices in order for communications to be established between them.

Wi-Fi®

Wi-Fi Certification assures tested and proven interoperability by the Wi-Fi Alliance, a group certifying interoperability among wireless LAN devices.

WPA (Wi-Fi Protected Access)

This is a security standard established by the Wi-Fi Alliance. In addition to the conventional SSID (network name) and WEP key (network key), it also uses a user identification function and encrypting protocol for stronger security.

WPA2 (Wi-Fi Protected Access 2)

This is a new version of the WPA established by the Wi-Fi Alliance, compatible with more secure AES encryption.

WPA/WPA2-Personal

This is a simple authentication system for mutual authentication when a preset character string matches on the wireless LAN access point and client.

WPA2/WPA3-Personal

WPA2/WPA3-Personal Mode was defined by Wi-Fi Alliance® to minimize user disruption and provide a gradual migration path to WPA3-Personal while maintaining interoperability with WPA2-Personal only devices.

WPA3-Personal

WPA3-Personal replaces the WPA2-Personal Pre-Shared Key (PSK) authentication with Simultaneous authentication of equals (SAE). Unlike PSK, SAE is resistant to offline dictionary attacks.

Network Names (SSID: Service Set Identifier)

When forming wireless LAN networks, groups are formed to prevent interference, data theft, etc. These groups are based on “SSID (network names)”.



■ Others

HDCP

When transmitting digital signals between devices, this copyright protection technology encrypts the signals to prevent content from being copied without authorization.

MAIN ZONE

The room where this unit is placed is called the MAIN ZONE.

Pairing

Pairing (registration) is an operation that is required in order to connect a Bluetooth device to this unit using Bluetooth. When paired, the devices authenticate each other and can connect without mistaken connections occurring.

When using Bluetooth connection for the first time, you need to pair this unit and the Bluetooth device to be connected.

Protection circuit

This is a function to prevent damage to devices within the power supply when an abnormality such as an overload, excess voltage occurs or over temperature for any reason.



Trademark information



Apple, AirPlay, iPad, iPad Air, iPad Pro and iPhone are trademarks of Apple Inc., registered in the U.S. and other countries.

The trademark "iPhone" is used in Japan with a license from Aiphone K.K.

Use of the Works with Apple badge means that an accessory has been designed to work specifically with the technology identified in the badge and has been certified by the developer to meet Apple performance standards.



Manufactured under license from Audyssey Laboratories™. U.S. and foreign patents pending. Audyssey MultEQ® XT32, Audyssey Dynamic EQ®, Audyssey Dynamic Volume® and Audyssey LFC™ are registered trademarks of Audyssey Laboratories.



Manufactured under license from Auro Technologies. Auro-3D® and the related symbols are registered trademarks of Auro Technologies. All materials contained in this work are protected by copyright law and may not be reproduced, distributed, transmitted, displayed, published or broadcast without the prior written permission of Auro Technologies NV or in case of third party materials, the owner of that content. You may not alter or remove any trademark, copyright or other notice from copies of the content.

Auro Technologies: mail info@auro-technologies.com, phone +32-(0)-14314343, fax +32-(0)-14321224, www.auro-technologies.com





The Bluetooth® word mark and logos are registered trademarks owned by the Bluetooth SIG, Inc. and any use of such marks by D&M Holdings Inc. is under license. Other trademarks and trade names are those of their respective owners.



Manufactured under license from Dolby Laboratories. Dolby, Dolby Atmos, Dolby Audio, Dolby Vision, and the double-D symbol are trademarks of Dolby Laboratories Licensing Corporation. Confidential unpublished works. Copyright © 1992-2022 Dolby Laboratories. All rights reserved.



For DTS patents, see <http://patents.dts.com>. Manufactured under license from DTS, Inc. DTS, DTS:X Pro, DTS:X, Virtual:X, and the DTS:X logo are registered trademarks or trademarks of DTS, Inc. in the United States and other countries. © 2021 DTS, Inc. ALL RIGHTS RESERVED.



The terms HDMI and HDMI High-Definition Multimedia Interface, and the HDMI Logo are trademarks or registered trademarks of HDMI Licensing, LLC in the United States and other countries.

HDR10+™ logo is a trademark of HDR10+ Technologies, LLC.





Manufactured under license from IMAX Corporation. IMAX® is a registered trademark of IMAX Corporation in the United States and/or other countries. All Rights Reserved. For DTS patents, see <http://patents.dts.com>. Manufactured under license from DTS, Inc. DTS, the Symbol, DTS and the Symbol together are registered trademarks or trademarks of DTS, Inc. in the United States and/or other countries © DTS, Inc. All Rights Reserved.



The Wi-Fi CERTIFIED logo is a registered trademark of the Wi-Fi Alliance.
Wi-Fi Certification provides assurance that the device has passed the interoperability test conducted by the Wi-Fi Alliance, a group that certifies interoperability among wireless LAN devices.



MPEG-H AUDIO

The MPEG-H TV Audio system logo is a trademark of Fraunhofer IIS and is registered in Germany and other countries.





App Store® is registered in the U.S. and other countries.



Google Play and the Google Play logo are trademarks of Google LLC.



Specifications

■ Audio section

• Power amplifier

Rated output:

Front:

150 W + 150 W (8 Ω /ohms, 20 Hz – 20 kHz with 0.05 % T.H.D.)

190 W + 190 W (6 Ω /ohms, 1 kHz with 0.7 % T.H.D.)

Center:

150 W (8 Ω /ohms, 20 Hz – 20 kHz with 0.05 % T.H.D.)

190 W (6 Ω /ohms, 1 kHz with 0.7 % T.H.D.)

Surround:

150 W + 150 W (8 Ω /ohms, 20 Hz – 20 kHz with 0.05 % T.H.D.)

190 W + 190 W (6 Ω /ohms, 1 kHz with 0.7 % T.H.D.)

Surround back / Height1 / Height2 / Height3 / Front wide:

150 W + 150 W (8 Ω /ohms, 20 Hz – 20 kHz with 0.05 % T.H.D.)

190 W + 190 W (6 Ω /ohms, 1 kHz with 0.7 % T.H.D.)

Dynamic power:

170 W x 2-channel (8 Ω /ohms)

280 W x 2-channel (4 Ω /ohms)

Output connectors:

4 – 16 Ω /ohms



- **Analog**

Input sensitivity:	Unbalanced RCA input : 200 mV Balanced XLR input : 400 mV
Frequency response:	10 Hz – 100 kHz — +1, -3 dB (Direct mode)
S/N:	102 dB (IHF-A weighted, Direct mode)
Distortion:	0.005 % (20 Hz – 20 kHz) (Direct mode)
Rated output:	Unbalanced RCA pre-output: 1.2 V Balanced XLR pre-output: 2.4 V

- **Digital**

D/A output:	Rated output — 2 V (at 0 dB playback) Total harmonic distortion — 0.002 % (1 kHz, at 0 dB) S/N ratio — 110 dB Dynamic range — 110 dB
Digital input:	Format — Digital audio interface

- **Phono equalizer**

Input sensitivity:	2.5 mV
RIAA deviation:	±1 dB (20 Hz to 20 kHz)
S/N:	74 dB (IHF-A)
Distortion factor:	0.03 % (1 kHz, 3 V)



■ Wireless LAN section

Network type (wireless LAN standard): Conforming to IEEE 802.11a/b/g/n/ac (Wi-Fi® compliant) *1

Security: WEP 64 bit, WEP 128 bit
WPA/WPA2-PSK (AES)
WPA/WPA2-PSK (TKIP)
WPA3-SAE (AES)

Used frequency range: 2.4 GHz, 5 GHz

*1 The Wi-Fi® CERTIFIED Logo and the Wi-Fi CERTIFIED On-Product Logo are registered trademarks of the Wi-Fi Alliance.



■ Bluetooth section





Communications system:	Bluetooth Specification Version 5.0
Transmission power:	Bluetooth Specification Power Class 1
Maximum communication range:	Approx. 30 m in line of sight *2
Used frequency range:	2.4 GHz
Modulation scheme:	FHSS (Frequency-Hopping Spread Spectrum)
Supported profiles:	Receiver function A2DP (Advanced Audio Distribution Profile) 1.2 AVRCP (Audio Video Remote Control Profile) 1.5 Transmitter function A2DP (Advanced Audio Distribution Profile) 1.2
Corresponding codec:	SBC
Transmission range (A2DP):	20 Hz – 20,000 Hz

*2 The actual communication range varies depending on the influence of such factors as obstructions between devices, electromagnetic waves from microwave ovens, static electricity, cordless phones, reception sensitivity, antenna performance, operating system, application software etc.



■ General

Operating temperature:	5 °C - 35 °C
Power supply:	AC 230 V, 50/60 Hz
Power consumption:	1100 W
Power consumption in standby modes:	

Standby modes	Setting items in the menu				Power consumption
	Network Control ( p. 247)	Wi-Fi and Bluetooth ( p. 250)	Allow Update ( p. 262)	HDMI Pass Through ( p. 186) / HDMI Control ( p. 188)	
Normal standby	Off In Standby	–	Off	Off	0.1 W
Network control (Bluetooth)	Always On	Wi-Fi:Disabled / Bluetooth:Enabled	–	Off	2.0 W
Network control (Ethernet)	Always On	Wi-Fi:Disabled / Bluetooth:Disabled	–	Off	2.0 W
Network control (Wi-Fi)	Always On	Wi-Fi:Enabled / Bluetooth:Disabled	–	Off	2.0 W
Network control (Wi-Fi, Bluetooth, CEC)	Always On	Wi-Fi:Enabled / Bluetooth:Enabled	–	On	2.5 W
CEC standby	Off In Standby	–	Off	On	0.5 W
RS-232C standby *	Off In Standby	–	Off	Off	0.5 W

* When this unit is in standby mode by sending a standby command from the external controller via the RS-232C connector of this unit.

For purposes of improvement, specifications and design are subject to change without notice.



■ Dimensions (Unit : mm)

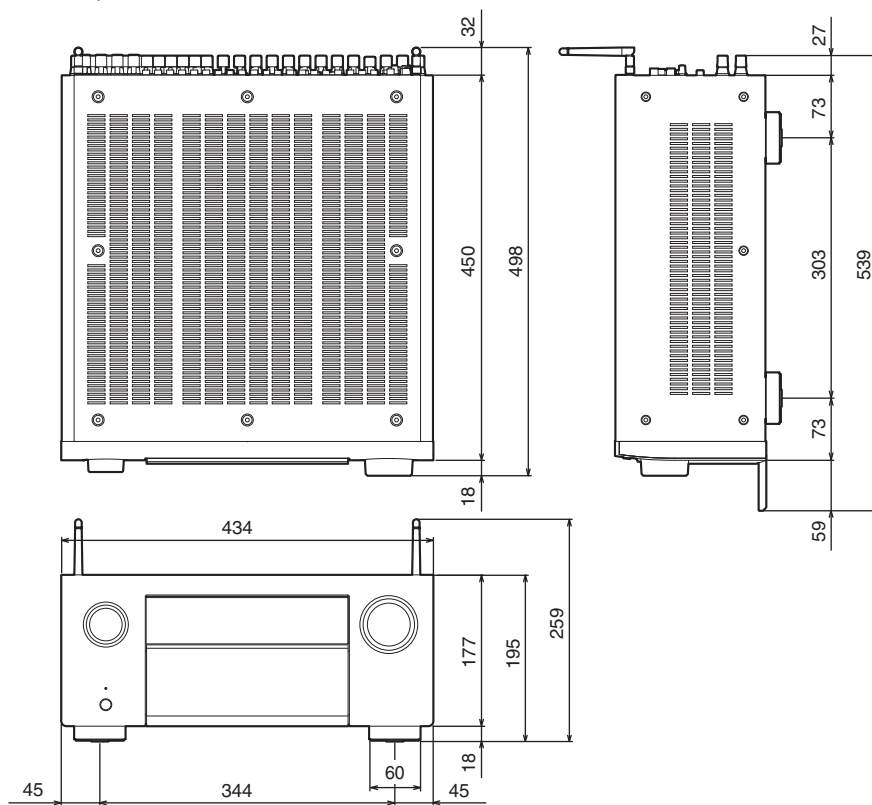

■ Weight : 32.0 kg

Front panel

Display

Rear panel

337

Remote

Index



Index

Numerics

11.1-channel	53
13.1-channel	56
15.1-channel	59
17.1-channel	60
3D	298
4K/8K	298
5.1-channel	47
7.1-channel	48
9.1-channel	50

A

AirPlay	113
All Zone Stereo	125
Audio formats	300, 304, 306, 307
Audio settings	164, 170
Audyssey Dynamic EQ®	317
Audyssey Dynamic Volume®	317
Audyssey LFC™	317
Audyssey MultEQ® XT32	317
Audyssey settings	181, 204
Audyssey Sub EQ HT™	203
Audyssey® Setup	202
Auto sound mode	130
Auto Standby	255

B

Bi-amp	61
Bluetooth device	92
Blu-ray Disc player	75, 86

C

Cable TV	73
----------------	----

D

Direct sound mode	135
Display	22
Dolby Atmos	318
Dolby sound mode	131, 319
DTS sound mode	132, 320
DVD player	75, 86

E

ECO Mode	252
External control device	81



 F

Firmware Update	261
Front panel	18

 G

Game console	76
General settings	167, 252

 H

HDCP	301
HDMI Control	141, 188
HEOS Account	105, 251
HEOS Favorites	118

 I

Input Assign	197
Input settings	165, 197
Input source	85
Internet Radio	98

 L

Listening position	202
--------------------------	-----

 M

Menu map	164
Muting	86

 N

NAS	100
Network settings	243

 O

Original sound mode	134
---------------------------	-----

 P

Pairing	92, 93
PC	100
PCM multi-channel sound mode	134
Protection circuit	327
Pure direct	130

 Q

Queue	88, 101, 108
Quick select plus	144



**R**

Rear panel	24
Remote control unit	28
Resetting factory settings	295
Resetting network settings	296
Restorer	179

**S**

Satellite tuner	73
Set-top box	73
Setup Assistant	168
Sleep timer	142
Sound mode	128
Speaker connection	38
Speaker settings	165, 202
Spotify	116
Stereo sound mode	135

**T**

Tips	271
Troubleshooting	273
TV	70, 71

**U**

USB memory device	78, 87
-------------------------	--------

**V**

Video Select	124
Video settings	164, 186
Volume	86, 120

**W**

Web control	151
Wi-Fi settings	244
Wired LAN	79, 243
Wireless LAN	80, 244

**Z**

ZONE2/ZONE3	65, 155
-------------------	---------



DENON[®]

www.denon.com

3520 10850 00ADA

©2022 Sound United. All Rights Reserved.