

Technical Description and User Manual

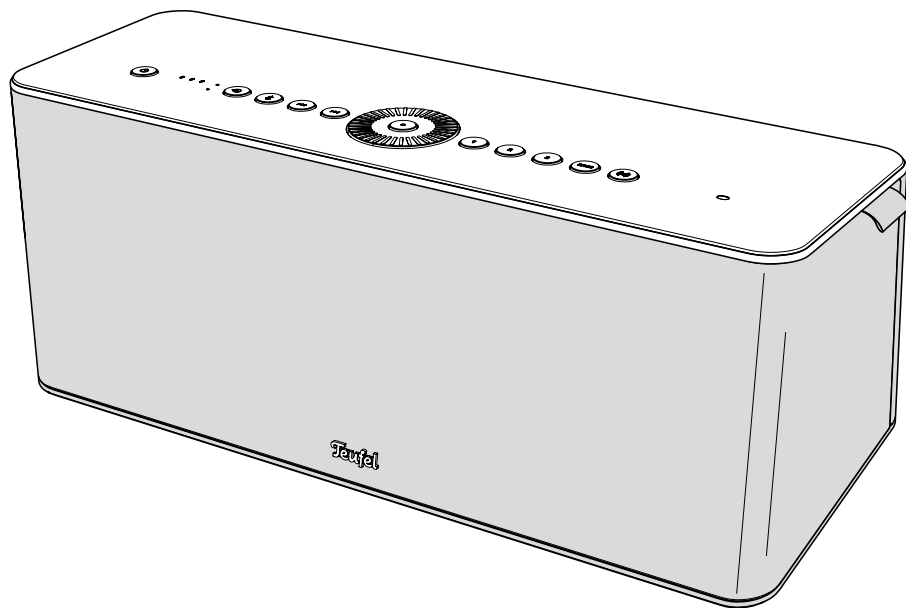

MOTIV®

MOTIV® HOME

Streaming speaker

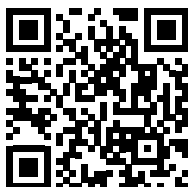

Teufel

Table of contents

| | |
|---------------------------------------|--|
| Basic notes and information.....4 | Standby mode 16 |
| For your information4 | Activate standby mode..... 16 |
| Validity of the user manual4 | Deactivate standby mode..... 16 |
| Data protection and | Auto standby 16 |
| advertising declaration.....5 | Auto-ON 16 |
| Original packaging 5 | Adjusting the volume17 |
| Complaint5 | Mute (only in AUX mode).....17 |
| Contact.....5 | Playback..... 18 |
| Safety.....6 | Pausing and starting playback 18 |
| Intended use.....6 | Playing the previous track..... 18 |
| Explanation of warnings6 | Playing the next track 18 |
| Scope of supply7 | Fast forward and rewind 18 |
| Operating and display elements8 | Switching Dynamore® on and off19 |
| Connections..... 10 | Adjusting the bass20 |
| Status LED display scheme 11 | Display the bass level20 |
| Commissioning12 | Adjusting the bass level20 |
| Setup12 | Changing the source21 |
| Connection.....12 | Presets21 |
| Loudspeaker setup13 | Saving presets.....21 |
| Teufel Home App.....13 | Selecting presets21 |
| Functions of the | Charging the battery 22 |
| Teufel Home App.....13 | Displaying the charge level..... 22 |
| Start Wi-Fi setup mode 14 | Activating power saving mode 23 |
| Operation.....15 | Using the power bank24 |
| Switching on and off.....15 | Power bank functions |
| Switching on15 | (during mains operation)24 |
| Switching off15 | Power bank functions |
| Auto-Off (only in battery mode)....15 | (during battery operation).....24 |
| | Light sensor24 |

| | |
|---|----|
| Playback sources (source) | 25 |
| Bluetooth® | 25 |
| Pairing devices | 25 |
| Disconnecting the Bluetooth® connection..... | 25 |
| Deleting the Bluetooth® list..... | 25 |
| Setting Bluetooth® as source..... | 25 |
| AUX (analogue)..... | 26 |
| AUX playback | 26 |
| Mute (AUX playback) | 26 |
| Wi-Fi sources | 27 |
| TuneIn Radio | 27 |
| Spotify® Connect..... | 27 |
| AirPlay | 27 |
| Google Cast™..... | 27 |
| TIDAL Connect..... | 27 |
| Cleaning and care..... | 28 |
| Troubleshooting..... | 29 |
| Perform a hardware reset..... | 30 |
| Resetting to factory settings..... | 30 |
| Technical data | 31 |

Basic notes and information

For your information

The information in this document is subject to change without notice and does not constitute any obligation on the part of Lautsprecher Teufel GmbH.

No part of these user manuals may be reproduced, transmitted in any form or by any means electronically, mechanically, by photocopying or by recording without the prior written permission of Lautsprecher Teufel GmbH.

© Lautsprecher Teufel GmbH
Teufel MOTIV® HOME UJM EN V1.3 PD

Validity of the user manual

The user manual applies exclusively to the **MOTIV® HOME** loudspeaker, hereinafter also referred to as the “loudspeaker”.

Trademark

© All trademarks are the property of their respective owners and any use by Lautsprecher Teufel is under licence.



Bluetooth® is a registered trademark of the Bluetooth SIG, Inc.

Google Cast™ is a trademark of Google LLC.

Apple and AirPlay are trademarks of Apple Inc., registered in the U.S. and other countries and regions.

Spotify® is subject to third-party licences. Click on the following links to view the licences:

<https://developer.spotify.com/legal/third-party-licenses/#embedded-sdk-third-party-license>

TIDAL, TIDAL Connect and corresponding logos are registered trademarks of Aspiro AB.

Data protection and advertising declaration

Lautsprecher Teufel GmbH does not store any personal data and is not involved in any promotional mailings.

Original packaging

If you wish to make use of the right of return, we must ask you to be sure to keep the packaging.

We can only take back loudspeakers in their original packaging.

Empty cartons are not available!

Complaint

In the event of a complaint, we absolutely need the following information for processing:

1. Invoice number

- ▶ Please refer to the proof of purchase (enclosed with the loudspeaker) or the order confirmation that you received as a PDF document.

2. Serial number

- ▶ The serial number can be found on the bottom of the loudspeaker.

Contact

If you have any questions, suggestions or criticism, please contact our Service:

Lautsprecher Teufel GmbH

BIKINI Berlin

Budapester Straße 44

10787 Berlin (Germany)

Phone:

Germany: +49 (0) 30 217 84 217

Austria: +43 12 05 22 3

Switzerland: +41 43 50 84 08 3

International: 0800 200 300 40 (toll- free)

Online-Support:

teufelaudio.com/support

teufel.de/support

Contact:

teufelaudio.com/contact

teufel.de/kontakt

Safety

Intended use

The loudspeaker is used to play back audio via the Internet or from an external player via a Wi-Fi, Bluetooth® or wired connection.

- ▶ Only use the loudspeaker as described in this user manual.

Any other use is deemed to be improper and may result in material damage or even personal injury.

The manufacturer accepts no liability for damage caused by improper use.

The loudspeaker is intended for use in the private sphere.

Before using the loudspeaker:

- ▶ Read the user manual and safety booklet carefully.
- ▶ Keep the instructions in a safe place so that they can be passed on to third parties.

Explanation of warnings

The action-related warnings warn against residual dangers and are located in front of a dangerous action step.

The warnings are graded with regard to their danger.

The hazard levels with the corresponding signal words are explained below.

WARNING

Possible danger to life or serious injury.

ATTENTION

Possible property damage.

NOTE

Additional information and tips.

Scope of supply

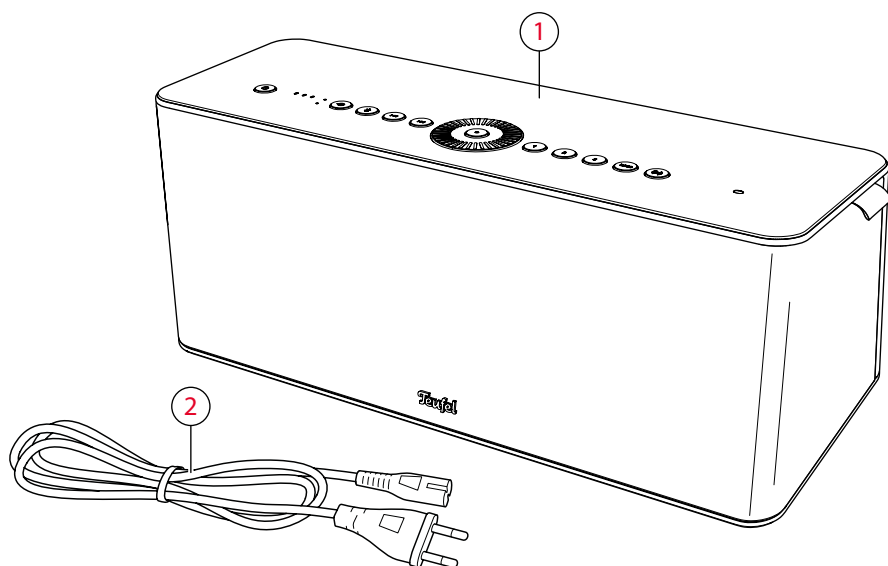

Scope of supply

(1) MOTIV® HOME

(2) Mains cable

- ▶ Check the scope of supply for completeness.
- ▶ Check the scope of supply for damage.
- ▶ Keep the original packaging during the warranty period.

Operating and display elements

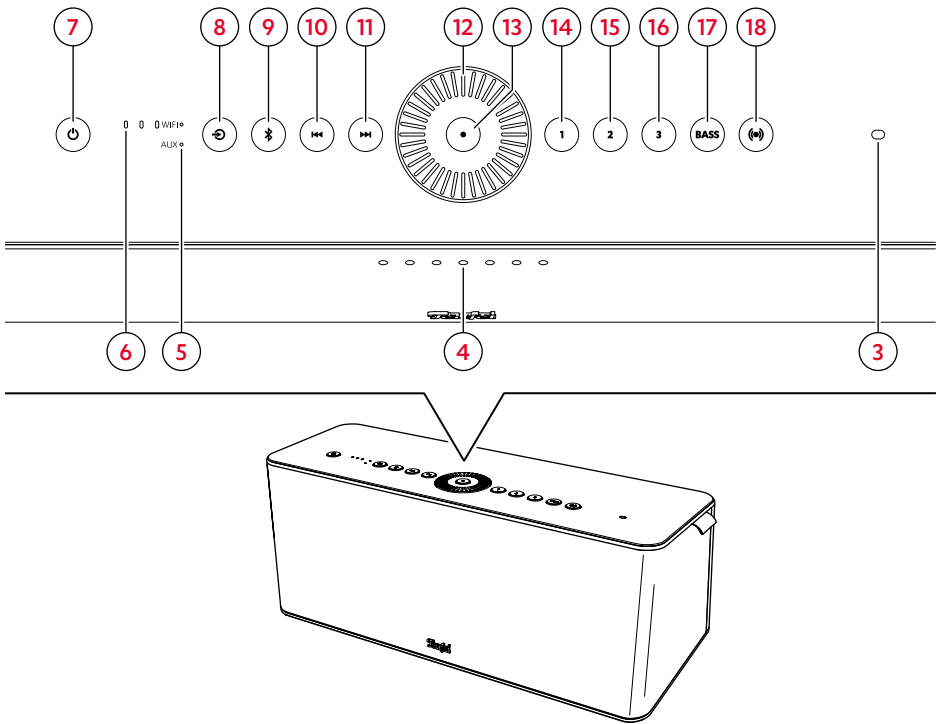

Operating and display elements

| No. | LED / sensor | Function |
|-----|-------------------|--|
| (3) | Light sensor | Automatically controls the brightness of the LEDs. → Light sensor – p. 24 |
| (4) | Status LEDs | Displays various statuses, such as the volume and charge level and indicates operations such as the Bluetooth® search, etc. → Status LED display scheme – p. 11 |
| (5) | Source LEDs | Indicates whether AUX mode or Wi-Fi mode is active. The Wi-Fi LED lights up green when Spotify® Connect is an active streaming source. → Changing the source – p. 21 |
| (6) | Wi-Fi status LEDs | Indicates the current Wi-Fi status. A red LED indicates that there is no connection between the loudspeaker and Wi-Fi router. |

Legend (actuation):

 = Press once

 = Press twice





























 = Press and hold (1.5 s)

 = Press and hold (4 s)

 = Press and hold (8 s)

 = Turn anticlockwise

 = Turn clockwise

| No. | Button | Function | Actuation |
|------|--|---|---|
| (7) |  Power | <i>Switching on and off – p. 15</i> |  /  |
| | | <i>Activate standby mode – p. 16</i> |  |
| | | <i>Displaying the charge level – p. 22</i> |  |
| | | <i>Perform a hardware reset – p. 30</i> |  |
| (8) |  Source | <i>Changing the source – p. 21</i> (> Spotify® Connect > TuneIn > AUX >) |  |
| (9) |  Bluetooth® | <i>Setting Bluetooth® as source – p. 25</i> |  |
| | | <i>Pairing devices – p. 25</i> |  |
| | | <i>Deleting the Bluetooth® list – p. 25</i> |  |
| (10) |  Previous | <i>Playing the previous track – p. 18</i> (Bluetooth® and Wi-Fi mode) |  |
| (11) |  Next | <i>Playing the next track – p. 18</i> (Bluetooth® and Wi-Fi mode) |  |
| (12) |  Volume Wheel | <i>Adjusting the volume – p. 17</i> |  |
| | | <i>Adjusting the bass level – p. 20</i> |  |
| (13) |  Centre | <i>Pausing and starting playback – p. 18</i> (Bluetooth® and Wi-Fi mode) |  |
| | | <i>Mute (AUX playback) – p. 26</i> |  |
| (14) |  Preset 1-3 | <i>Saving presets – p. 21</i> (radio station, playlist or track) |  |
| (16) | | <i>Selecting presets – p. 21</i> |  |
| (17) |  Bass | <i>Display the bass level – p. 20</i> |  |
| (18) |  Dynamore® | <i>Switching Dynamore® on and off – p. 19</i> |  |

Connections

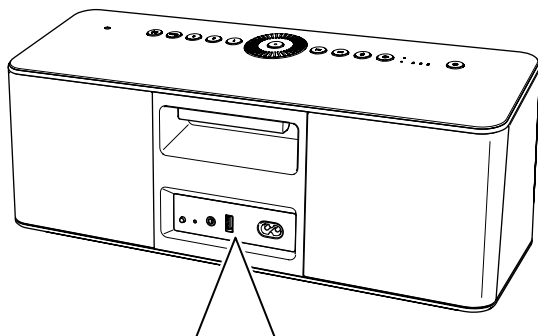

5V $\overline{\text{---}}$ 1500mA

220-240V-50Hz
90WATTS

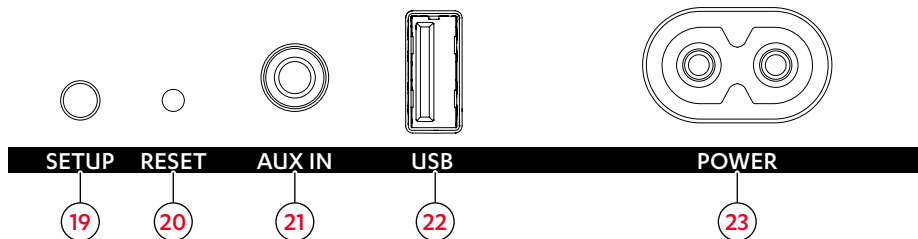

Connections on the back

Legend (actuation):

● = Press once

1.5 s = Press and hold (1.5 s)

| No. | Name | Function | Actuation |
|------|-------------|---|--------------|
| (19) | Wi-Fi setup | Start Wi-Fi setup mode – p. 14 | 1.5 s |
| (20) | Reset | Resetting to factory settings – p. 30 | ● |
| (21) | AUX IN | AUX (analogue) – p. 26 (Connection for external devices) | Plug-in |
| (22) | USB | Using a power bank – p. 24 (Power bank connection for charging external devices) | Plug-in |
| (23) | Power | Connection – p. 12 | Plug-in |

Status LED display scheme

Key:

○ = LED off

⊛ = LED flashing

◐ = LED lights up dimly

● = LED lights up brightly

Volume:

| Status LEDs | Volume |
|-----------------------------|----------|
| ○ ○ ⊛ ⊛ ⊛ ○ ○ | 0 % |
| ◐ ○ ○ ○ ○ ○ ○ ○ | 1-7 % |
| ● ○ ○ ○ ○ ○ ○ ○ | 8-15 % |
| ● ◐ ○ ○ ○ ○ ○ ○ ○ | 16-22 % |
| ● ● ○ ○ ○ ○ ○ ○ ○ | 23-29 % |
| ● ● ◐ ○ ○ ○ ○ ○ ○ ○ | 30-35 % |
| ● ● ● ○ ○ ○ ○ ○ ○ ○ | 36-42 % |
| ● ● ● ◐ ○ ○ ○ ○ ○ ○ ○ | 43-49 % |
| ● ● ● ● ○ ○ ○ ○ ○ ○ ○ | 50-56 % |
| ● ● ● ● ◐ ○ ○ ○ ○ ○ ○ ○ | 57-63 % |
| ● ● ● ● ● ○ ○ ○ ○ ○ ○ ○ | 64-70 % |
| ● ● ● ● ● ◐ ○ ○ ○ ○ ○ ○ ○ | 71-77 % |
| ● ● ● ● ● ● ○ ○ ○ ○ ○ ○ ○ | 78-84 % |
| ● ● ● ● ● ● ◐ ○ ○ ○ ○ ○ ○ ○ | 85-92 % |
| ● ● ● ● ● ● ● ○ ○ ○ ○ ○ ○ ○ | 93-100 % |

Statuses:

| Status LEDs | Status |
|---------------|------------------|
| ● ● ○ ○ ○ ● ● | Wi-Fi setup mode |

Bass level:

| Status LEDs | Bass level |
|---------------------|------------|
| ● ● ● ● ○ ○ ○ | -6 dB |
| ◐ ● ● ● ○ ○ ○ ○ | -5 dB |
| ○ ● ● ● ○ ○ ○ ○ | -4 dB |
| ○ ◐ ● ● ○ ○ ○ ○ | -3 dB |
| ○ ○ ● ● ○ ○ ○ ○ | -2 dB |
| ○ ○ ◐ ● ○ ○ ○ ○ | -1 dB |
| ○ ○ ○ ● ○ ○ ○ ○ | 0 dB |
| ○ ○ ○ ● ◐ ○ ○ ○ | +1 dB |
| ○ ○ ○ ● ● ○ ○ ○ | +2 dB |
| ○ ○ ○ ● ● ◐ ○ ○ ○ | +3 dB |
| ○ ○ ○ ● ● ● ○ ○ ○ | +4 dB |
| ○ ○ ○ ● ● ● ◐ ○ ○ ○ | +5 dB |
| ○ ○ ○ ● ● ● ● ○ ○ ○ | +6 dB |

Charge level:

| Status LEDs | Battery % |
|-----------------------------|-----------|
| ⊛ ○ ○ ○ ○ ○ ○ ○ | 0-10 % |
| ● ○ ○ ○ ○ ○ ○ ○ | 11-15 % |
| ● ● ○ ○ ○ ○ ○ ○ ○ | 16-28 % |
| ● ● ● ○ ○ ○ ○ ○ ○ ○ | 29-42 % |
| ● ● ● ● ○ ○ ○ ○ ○ ○ ○ | 43-56 % |
| ● ● ● ● ● ○ ○ ○ ○ ○ ○ ○ | 57-70 % |
| ● ● ● ● ● ● ○ ○ ○ ○ ○ ○ ○ | 71-84 % |
| ● ● ● ● ● ● ● ○ ○ ○ ○ ○ ○ ○ | 85-100 % |

Commissioning

Setup

ATTENTION

Material damage due to improper installation!

At very high volumes and bass-driven music, the loudspeaker may move due to vibration and fall.

- ▶ Only place the loudspeaker on a stable and level surface.
- ▶ Do not place any objects on the loudspeaker.

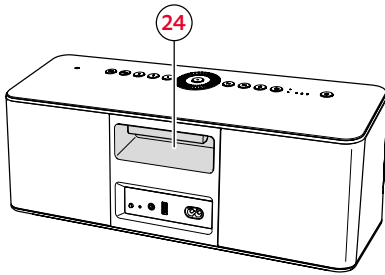

1. Hold the loudspeaker by the handle (24) and carry it carefully to the installation site.
2. Place the loudspeaker on a stable and level surface.
 - ▶ Avoid proximity to heat sources and direct sunlight.
 - ▶ Do not place any objects on the loudspeaker.

✓ The loudspeaker is set up.

Connection

ATTENTION

Property damage due to tripping hazard!

An awkwardly laid mains cable can become a tripping hazard and possibly pull down and damage the loudspeaker.

- ▶ Lay the mains cable in such a way that it does not cause tripping hazards for people and animals.

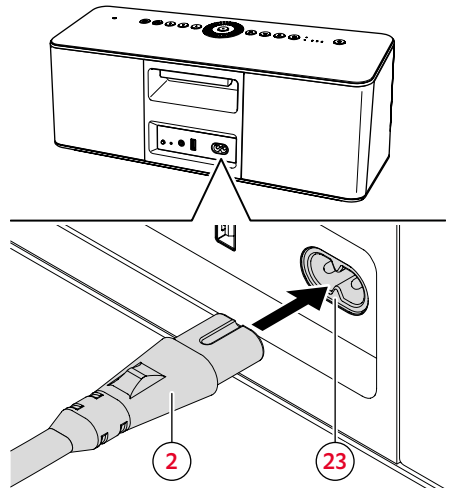

1. Connect the mains cable (2) to the loudspeaker power socket (23).
2. Connect the mains cable (2) to a mains socket.

✓ The loudspeaker is connected.

Loudspeaker setup

Teufel Home App

The loudspeaker is set up in the Teufel Home App.

1. Download the Teufel Home App.

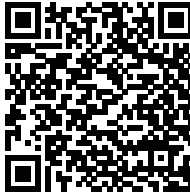
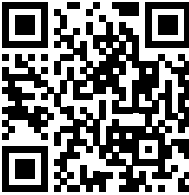

2. Switch on the loudspeaker.
→ *Switching on – p. 15*
 3. Start Wi-Fi setup mode.
→ *Start Wi-Fi setup mode – p. 14*
 4. Follow the instructions in the app.
- The loudspeaker is set up in the app and connected to the Wi-Fi.**
(Wi-Fi status LED lights up white.)

i NOTE

The Wi-Fi status LED lights up red when there is no Wi-Fi connection.

i NOTE

The loudspeaker can also be used without the app or a Wi-Fi connection (e.g. via Bluetooth®).

Functions of the Teufel Home App

The Teufel Home App can be used for the following functions:

- ▶ Setting up the network.
- ▶ Updating the firmware.
- ▶ Setting up power saving mode.
- ▶ Setting the brightness of the LEDs.
- ▶ Setting presets.
- ▶ Setting up Internet Radio.
- ▶ Setting up streaming services.
- ▶ Controlling playback.
(play, pause, previous, next, stop, etc.)
- ▶ Setting the volume.
- ▶ Setting the equalizer.
- ▶ Setting automatic functions.
(Auto-Off/On, Auto standby)

Start Wi-Fi setup mode

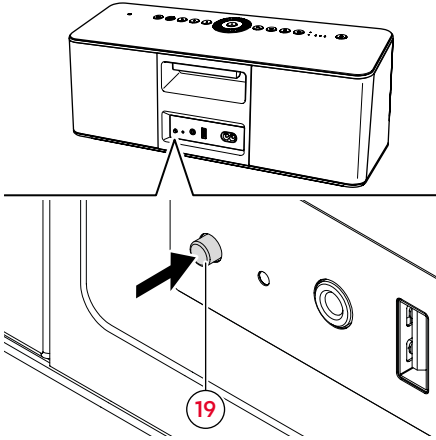

- ▶ Press and hold down the Wi-Fi setup button (19) on the back for 1.5 seconds.
- ✔ The loudspeaker switches to the Wi-Fi setup mode. (The two outermost status LEDs light up.)

i NOTE

Wi-Fi setup mode is deactivated automatically after 15 minutes.

Operation

Switching on and off

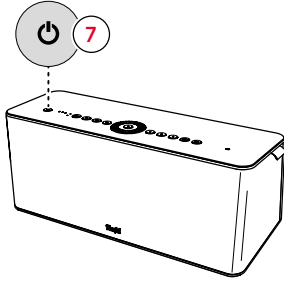

Auto-Off (only in battery mode)

- ▶ Set the Auto-Off timer in the Teufel Home App.

Switching on

1. Press the power button (7).
2. Wait (approx. 30 seconds) until the loudspeaker is fully started.

The loudspeaker is switched on.

i NOTE

The wait time does not apply when the loudspeaker is powered up from standby mode.

Switching off

- ▶ Press the power button (7) and keep it pressed for 4 seconds.

The loudspeaker is switched off and disconnected from the Wi-Fi. (All LEDs are off.)

i NOTE

When the loudspeaker is switched off, all functions are inactive. The loudspeaker cannot be switched on via the Wi-Fi.

Standby mode

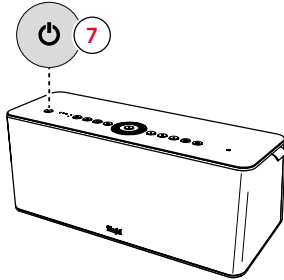

Activate standby mode

- ▶ Press the power button (7).
- ✔ Standby mode is activated. (Only the power button LED lights up.)

i NOTE

In standby mode, the loudspeaker is inactive but remains connected to the Wi-Fi. As a result, the loudspeaker can still be controlled via the Wi-Fi.

Deactivate standby mode

- ▶ Press the power button (7).
- ✔ Standby mode is deactivated and the loudspeaker is on.

Auto standby

After 5 minutes without an input signal, the loudspeaker automatically switches to standby mode.

- ▶ Set the Auto standby timer in the Teufel Home App.

Auto-ON

Automatic activation of the loudspeaker from standby mode, when:

- Playback from the Bluetooth® player,
- Start of playback via Wi-Fi,
- Playback from the AUX player.

i NOTE

The Auto-ON function for the AUX input can be set in the Teufel Home App.

→ *Teufel Home App – p. 13*

Adjusting the volume

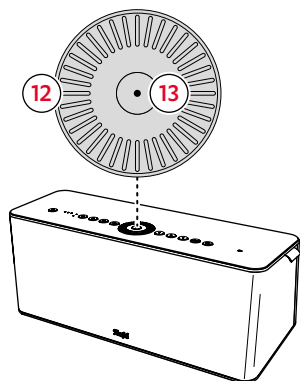

- ▶ Turn the volume wheel (12) anticlockwise.
- ☑ **The volume is reduced.**
- ▶ Turn the volume wheel (12) anticlockwise until the three middle status LEDs light up.
- ☑ **The volume = 0.**
- ▶ Turn the volume wheel (12) clockwise.
- ☑ **The volume is increased.**

i NOTE

The volume setting of the external player also affects the volume of the loudspeaker.

| Status LEDs | Volume |
|---------------|----------|
| ○ ○ ☆ ☆ ☆ ○ ○ | 0 % |
| ● ○ ○ ○ ○ ○ ○ | 1-7 % |
| ● ○ ○ ○ ○ ○ ○ | 8-15 % |
| ● ● ○ ○ ○ ○ ○ | 16-22 % |
| ● ● ○ ○ ○ ○ ○ | 23-29 % |
| ● ● ● ○ ○ ○ ○ | 30-35 % |
| ● ● ● ○ ○ ○ ○ | 36-42 % |
| ● ● ● ● ○ ○ ○ | 43-49 % |
| ● ● ● ● ○ ○ ○ | 50-56 % |
| ● ● ● ● ● ○ ○ | 57-63 % |
| ● ● ● ● ● ○ ○ | 64-70 % |
| ● ● ● ● ● ● ○ | 71-77 % |
| ● ● ● ● ● ● ○ | 78-84 % |
| ● ● ● ● ● ● ● | 85-92 % |
| ● ● ● ● ● ● ● | 93-100 % |

Mute (only in AUX mode)

- ▶ Press the Centre button (13).
- ☑ **The loudspeaker is muted.**
- ▶ Press the Centre button (13) again.
- ☑ **The loudspeaker is unmuted.**

Playback

- ▶ Start the first playback via the connected external player (e.g. smartphone).

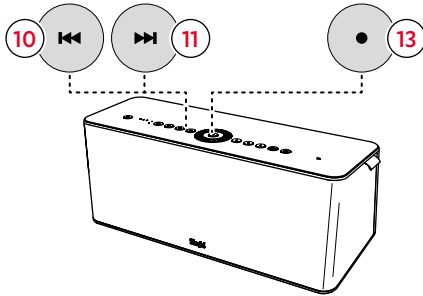

Pausing and starting playback

- ▶ Press the Centre button (13).
- ✔ Playback is paused/muted (depending on the source).
- ▶ Press the Centre button (13) again.
- ✔ Playback is started/unmuted (depending on the source).

Playing the previous track

- ▶ Press the Previous button (10).
- ✔ The current track is started from the beginning. (If the track has been played for more than 3 seconds.)
- ✔ The previous track is started. (If the track has been played for less than 3 seconds.)
- ▶ Press the Previous button (10) twice.
- ✔ The previous track is started.

Playing the next track

- ▶ Press the Next button (11).
- ✔ The next track is started.

Fast forward and rewind

- ▶ Press and hold the Previous button (10).
- ✔ The current track is rewound.
- ▶ Press and hold the Next button (11).
- ✔ The current track is fast forwarded.

i NOTE

The fast forward and rewind function is not yet supported during Bluetooth playback.

Switching Dynamore® on and off

Dynamore® is a technology developed by Teufel that virtually expands the stereo panorama to create an impressive, wide-ranging sound.

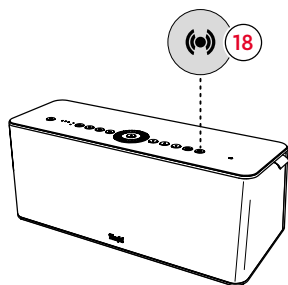

- ▶ Press the Dynamore® button (18).
- ☑ **Dynamore® is switched on.**
(The LED of the button lights up strongly.)
- ▶ Press the Dynamore® button (18) again.
- ☑ **Dynamore® is switched off.**

i NOTE

The use of Dynamore® shortens the operating time of the loudspeaker in battery mode.

Adjusting the bass

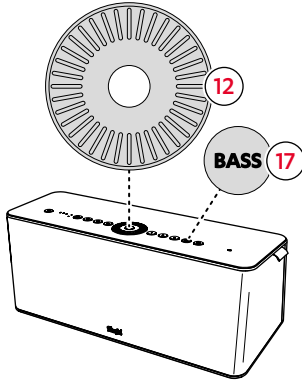

Display the bass level

- ▶ Press the Bass button (17).
- ✔ Bass Level mode is activated and the bass level can be adjusted using the volume wheel. (The status LEDs indicate the bass level.)
- ▶ Press the Bass button (17) again.
- ✔ Bass Level mode is deactivated.

i NOTE

Bass Level mode will deactivate automatically after 10 seconds and retain its current settings if there is no further interaction.

Adjusting the bass level

1. Activate Bass Level mode.
2. Adjust the bass level.
 - ▶ Turn the volume wheel (12) anticlockwise.
 - ✔ The base level is gradually reduced (up to -6 dB).
 - ▶ Turn the volume wheel (12) clockwise.
 - ✔ The base level is gradually increase (up to +6 dB).

| Status LEDs | Bass level |
|---------------|------------|
| ● ● ● ● ○ ○ ○ | -6 dB |
| ● ● ● ● ○ ○ ○ | -5 dB |
| ○ ● ● ● ○ ○ ○ | -4 dB |
| ○ ● ● ● ○ ○ ○ | -3 dB |
| ○ ○ ● ● ○ ○ ○ | -2 dB |
| ○ ○ ● ● ○ ○ ○ | -1 dB |
| ○ ○ ○ ● ○ ○ ○ | 0 dB |
| ○ ○ ○ ● ● ○ ○ | +1 dB |
| ○ ○ ○ ● ● ● ○ | +2 dB |
| ○ ○ ○ ● ● ● ● | +3 dB |
| ○ ○ ○ ● ● ● ● | +4 dB |
| ○ ○ ○ ● ● ● ● | +5 dB |
| ○ ○ ○ ● ● ● ● | +6 dB |

Changing the source

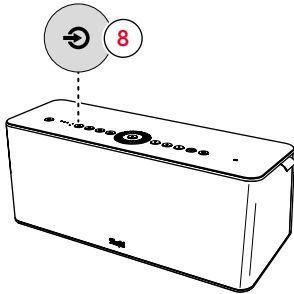

- ▶ Press the Source button (8).
- ☑ The playback source is changed in sequence:
(> Spotify® Connect > Wi-Fi > AUX >).

| Source LEDs | Active source |
|-----------------|------------------|
| WIFI ● AUX ○ | Spotify® Connect |
| WIFI ● AUX ○ | Wi-Fi |
| WIFI ○ AUX ● | AUX |

i NOTE

The loudspeaker detects the active source automatically, provided it was set up beforehand.

- ▶ Refer to the chapter Playback sources for more information.
→ *Playback sources (source)* – p. 25

Presets

Radio stations, playlists or tracks can be saved and retrieved again quickly using the preset function.

i NOTE

The preset function can only be used with compatible playback sources (Spotify® and TuneIn Radio).

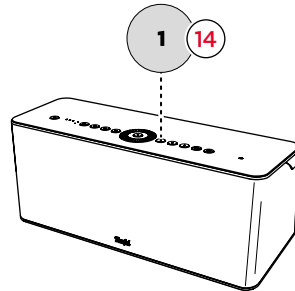

Saving presets

1. Play back radio station, playlist or track.
 2. Press and hold the Preset button (14, 15 or 16) for 1.5 seconds.
- ☑ The preset is saved to the selected preset button.

Selecting presets

- ▶ Press the Preset button (14, 15 or 16).
- ☑ The selected preset is played back.

Charging the battery

⚠ WARNING

Injury and material damage due to improper handling!

Batteries can explode if handled improperly and lead to personal injuries and defects of the loudspeaker.

- ▶ Do not heat, short-circuit or burn batteries.
- ▶ Protect batteries from direct sunlight.
- ▶ Only use the mains cable provided.

The integrated rechargeable battery starts charging as soon as the loudspeaker is connected to a mains socket.

- ▶ Connect the loudspeaker.
→ *Connection – p. 12*

- ✔ **The battery is charging.**

i NOTE

The fully charged battery allows an operating time of approx. 11 hours at medium volume.

i NOTE

When the battery is low, the loudspeaker will beep every 15 minutes and the left LED will flash for 2 minutes.

Displaying the charge level

The seven status LEDs on the front of the loudspeaker can indicate the current charge level of the battery.

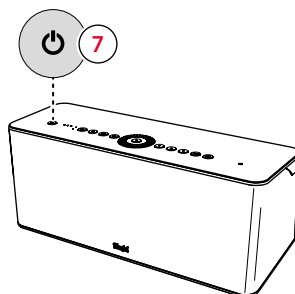

- ▶ Press the power button twice.

- ✔ **The charge level is displayed.**

The number of LEDs that light up represents an approximate value of the current charge level.

| Status LEDs | Battery % |
|---------------|-----------|
| ★ ○ ○ ○ ○ ○ ○ | 0-10 % |
| ● ○ ○ ○ ○ ○ ○ | 11-15 % |
| ● ● ○ ○ ○ ○ ○ | 16-28 % |
| ● ● ● ○ ○ ○ ○ | 29-42 % |
| ● ● ● ● ○ ○ ○ | 43-56 % |
| ● ● ● ● ● ○ ○ | 57-70 % |
| ● ● ● ● ● ● ○ | 71-84 % |
| ● ● ● ● ● ● ● | 85-100 % |

i NOTE

To protect the battery, the loudspeaker has a deep discharge protection that switches off the loudspeaker when the threshold is reached.

It is then no longer possible to switch on the loudspeaker again without the mains cable connected and the battery charged.

Activating power saving mode

Power-saving mode can be activated via the Teufel Home App to help extend the battery life of the loudspeaker.

→ *Teufel Home App – p. 13*

Using the power bank

The USB port on the back serves as a power bank connection and can charge connected external players (e.g. smartphones).

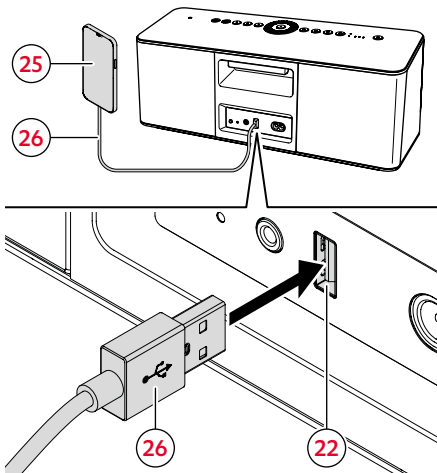

1. Connect the USB cable (26) to the USB port (22).
2. Connect the USB cable (26) to a external player (25), e.g. a smartphone.

✓ **The external player is being charged.**

i NOTE

Using the power bank function shortens the operating time of the loudspeaker when it is operated on battery power.

The power bank function continues even when the loudspeaker is in standby mode.

The maximum charging current is 1.5 A.

Power bank functions (during mains operation)

If the loudspeaker is connected to the mains socket, the external player is charged in any operating state.

Power bank functions (during battery operation)

Requirements for charging the external player in battery mode:

- The loudspeaker is switched on and the battery charge level is at least 20 %,
- The loudspeaker is in standby mode and the battery charge level is at least 20 %,

The external player is not loaded:

- When the battery charge level is less than 20 %,
- the loudspeaker is switched off.

Light sensor

The integrated light sensor controls the brightness of all LEDs automatically.

Alternatively, the brightness of the LEDs can also be adjusted manually in the Teufel Home App.

→ *Teufel Home App – p. 13*

Playback sources (source)

Bluetooth®

A compatible player is connected wirelessly to the loudspeaker via Bluetooth®.

i NOTE

Only use the Bluetooth® function in places where wireless radio transmission is permitted.

Pairing devices

Pairing connects the external player with the loudspeaker.

i NOTE

Up to 7 external players can be stored and automatically connected without pairing again.

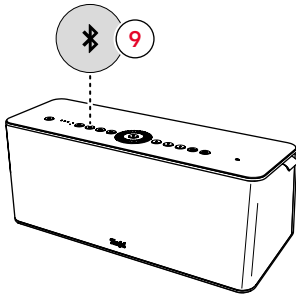

1. Activate the Bluetooth® function on the external player.
 2. Press the Bluetooth® button (9) and keep it pressed for 1.5 seconds.
- ☑ **Bluetooth® pairing mode is activated.** (Status LEDs are flashing and a "search tone" sounds.)

3. Search for Bluetooth® devices on the external player.
 - ▶ Follow the user manual of the external player.
4. Select the "Teufel MOTIV HOME" loudspeaker from the list of Bluetooth® devices.

- ☑ **The pairing procedure is completed. The Bluetooth® LED lights up continuously.**

- ▶ Use the loudspeaker as the output device.

Disconnecting the Bluetooth® connection

- ▶ Deactivate the Bluetooth® function on the external player.

- ☑ **The Bluetooth® connection has been disconnected.**

Deleting the Bluetooth® list

- ▶ Press the Bluetooth® button (1) and keep it pressed for 8 seconds.

- ☑ **The Bluetooth® list is deleted.** (All status LEDs flash once)

Setting Bluetooth® as source

- ▶ Press the Bluetooth® button (1).

- ☑ **Bluetooth® is set as the source.**

AUX (analogue)

A compatible player is connected to the analogue loudspeaker AUX.

AUX playback

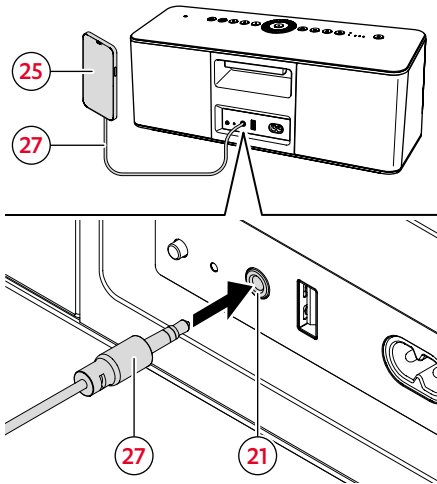

1. Connect the external player (25) to the AUX port (21) using a stereo cable (27) with a 3.5 mm jack plug.
- If a signal is present, the loudspeaker switches to AUX playback automatically.
2. Control the playback via the external player.
- The loudspeaker plays the track on the external player.

i NOTE

Any external player that has an AUX connection can be connected.

Mute (AUX playback)

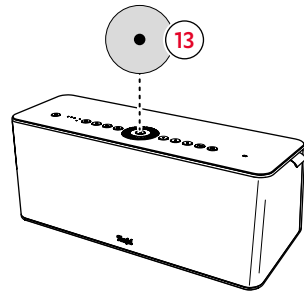

- ▶ Press the Centre button (13).
- Playback is muted.
- ▶ Press the Centre button (13) again.
- Playback is unmuted.

i NOTE

During AUX playback, the Centre button obtains the Mute function and loses the Start and Pause functions.

i NOTE

The Auto-ON function for the AUX input can be set in the Teufel Home App via the automatic source change feature.

→ *Teufel Home App* – p. 13

Wi-Fi sources

The loudspeaker is connected to the Internet and different streaming services via Wi-Fi.

TuneIn Radio

TuneIn Radio offers a combination of live sport, music, news and podcasts. TuneIn Radio is integrated directly in the Teufel Home and can be used without requiring further setup.

Spotify® Connect

Use your phone, tablet or computer as a remote control for Spotify.

- ▶ Go to spotify.com/connect to learn how.

AirPlay

AirPlay is Apple technology that allows you to control audio systems and loudspeakers in any room of your home from your iPhone, iPad, HomePod or Apple TV.

You can play a song in your living room and kitchen at the same time, or control the volume synchronously in each room.

Airplay is activated when your loudspeaker is connected to the network, and does not require further setup.

Google Cast™

Google Cast is a feature that lets you stream your favorite music from your phone, tablet or laptop right to your speakers. Easily control your speakers with apps you already know and love from your Android phone or tablet, iPhone®, iPad®, Mac® or Windows® laptop, or Chromebook.

TIDAL Connect

TIDAL is a streaming service for all music fans. With TIDAL Connect, you can stream your favourite music from the TIDAL app directly to your devices. TIDAL Connect allows listeners to use the TIDALmobile app as a controller so that they can enjoy TIDAL on all of their favourite TIDAL Connect devices.

- ▶ See <https://tidal.com/connect> for more information.

Cleaning and care

ATTENTION

Material damage due to improper cleaning!

The use of unsuitable cleaning agents can lead to the discolouration and destruction of the surface.

- ▶ Do not allow moisture to get inside.
- ▶ Clean the loudspeaker only with a dry, soft cloth.

-
1. Remove dust and light soiling with a dry leather cloth.
 2. Remove stubborn stains with a cloth slightly moistened with mild soapy water.
 3. Then rub damp surfaces dry with a dry, soft cloth without applying pressure.
- ☑ **The loudspeaker is cleaned.**

Troubleshooting

► Follow the instructions below to eliminate possible faults:

| Malfunction | Possible cause | Remedy |
|--|---|---|
| The loudspeaker does not start. | The battery is discharged. | <ul style="list-style-type: none"> ► Connect the loudspeaker and charge the battery. → <i>Charging the battery – p. 22</i> |
| No sound | The volume is too low. | <ul style="list-style-type: none"> ► Increase the volume. → <i>Adjusting the volume – p. 17</i> |
| | The volume on the external player is too low. | <ul style="list-style-type: none"> ► Increase the volume on the external player (e.g. smartphone). |
| | The loudspeaker is not connected to the external player. | <ul style="list-style-type: none"> ► Connect the loudspeaker to the external player. → <i>Teufel Home App – p. 13</i> → <i>Bluetooth® – p. 25</i> → <i>AUX (analogue) – p. 26</i> |
| | The loudspeaker is not set as the output device on the source player. | <ul style="list-style-type: none"> ► Set the loudspeaker as the output device in the settings of the external player. ► Observe the manufacturer's documentation for the external player. |
| | The Bluetooth® connection is disturbed by another radio system | <ul style="list-style-type: none"> ► Move the loudspeaker to another location. → <i>Setup – p. 12</i> |
| The playback of the external player is too quiet | The volume limiter on the source is active. (Android systems only) | <ul style="list-style-type: none"> ► Deactivate the volume limiter. ► Observe the manufacturer's documentation for the external player. |
| Loudspeaker does not respond | A system error has occurred | <ul style="list-style-type: none"> ► Press the power button (7) and keep it pressed for 8 seconds. |
| Connection terminated (Wi-Fi) | Loudspeaker is out of range of the router signal | <ul style="list-style-type: none"> ► Move the loudspeaker to another location. → <i>Setup – p. 12</i> ► Use the loudspeaker in the vicinity of the router. |
| | Internet/Wi-Fi failure. | <ul style="list-style-type: none"> ► Contact your Internet provider. ► Observe the manufacturer's documentation accompanying the router. |

Perform a hardware reset

i NOTE

Only perform a hardware reset if the loudspeaker does not respond.

- ▶ Before a hardware reset, check whether
 - The loudspeaker is waiting for an input,
 - The player is paused,
 - The loudspeaker is in setup mode.

- ▶ Consider alternatives, such as:
 - Disconnecting the Bluetooth® connection.
 - Disconnecting the Wi-Fi connection.
 - Disconnecting the power supply and
 - Restarting the loudspeaker.

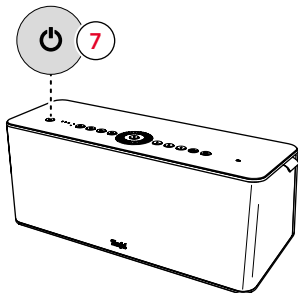

- ▶ Press the power button (7) and keep it pressed for 8 seconds.
- ✓ **The hardware reset has been carried out.**

Resetting to factory settings

i NOTE

All user settings and data are deleted and reset to the factory settings.

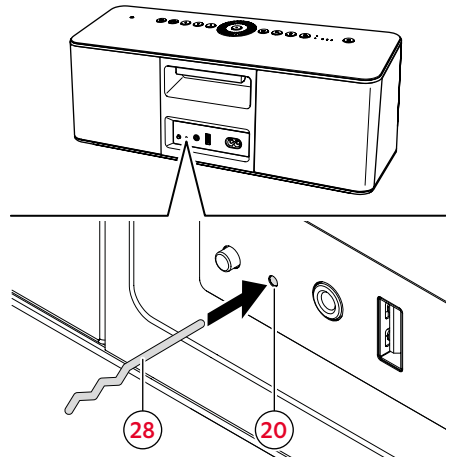

- ▶ Press the Reset button (20) through the housing with a paper clip (28) or similar object.
- ✓ **The loudspeaker is reset to its factory settings. All personal settings and links to accounts are deleted.**

Technical data

| General technical data | |
|------------------------|------------------------------|
| Dimensions (W x H x D) | 402 mm x 170 mm x 161 mm |
| Weight | 4.5 kg |
| Mains voltage | 220–240 V AC / 50 Hz |
| Battery | Lithium-Ion 11.1 V, 5200 mAh |
| USB charging current | 5 V, max. 1.5 A |
| Operating temperature | 0 °C to +45 °C |
| Storage temperature | -20 °C to +65 °C |

| Radio network | Frequency bands | Transmitting power |
|--------------------|--------------------|--------------------|
| Bluetooth® + Wi-Fi | 2400 – 2,483.5 MHz | <13 dBm/20 mW |
| Wi-Fi | 5150 – 5350 MHz | <20 dBm/100 mW |
| | 5725 – 5875 MHz | <14 dBm/25 mW |

| Network standby | |
|-------------------|-----------|
| Switch-off time | 5 Minutes |
| Power consumption | <2 W |



Hereby, Lautsprecher Teufel GmbH declares that the radio equipment type MOTIV® HOME is in compliance with Directive 2014/53/EU.

The full text of the EU declaration of conformity is available at the following internet address:

teufel.de/konformitaetserklaerungen

teufelaudio.com/declaration-of-conformity

Teufel

If you have any questions, suggestions or criticism, please contact our Service:

Lautsprecher Teufel GmbH

BIKINI Berlin
Budapester Straße 44
10787 Berlin (Germany)

teufelaudio.com

teufel.de

teufel.ch

teufelaudio.at

teufelaudio.nl

teufelaudio.be

teufelaudio.fr

teufelaudio.pl

teufelaudio.it

teufelaudio.es

Tel.:

Germany: +49 (0) 30 217 84 217

Austria: +43 12 05 22 3

Switzerland: +41 43 50 84 08 3

International: 00800 200 300 40 (toll-free)

Online support:

teufelaudio.com/support

teufel.de/support

Contact:

teufelaudio.com/contact

teufel.de/kontakt

All information is provided without guarantee.

Subject to technical changes.

Typographical and other errors excepted.